

DEVELOPMENT OF A SYSTEM-WIDE PREDATOR CONTROL  
PROGRAM: STEPWISE IMPLEMENTATION OF A PREDATION  
INDEX PREDATOR, CONTROL FISHERIES, AND  
EVALUATION PLAN IN THE COLUMBIA RIVER BASIN

Annual Report  
April – December 1991

Prepared by:

Anthony A. Nigro  
Charles F. Willis

Oregon Department of Fish and Wildlife

Cooperators:

Oregon Department of Fish and Wildlife  
Washington Department of Wildlife  
Columbia River Inter-Tribal Fish Commission  
Oregon State University  
Computer Sciences Corporation

Prepared for:

U. S. Department of Energy  
Bonneville Power Administration  
Environment, Fish and Wildlife Division  
PO Box 3621  
Portland, Oregon 97208-3621

Project Number: 90-077  
Contract Number: DE-BI79-90BP07084

February 1993

## CONTENTS

	<u>Page</u>
ACKNOWLEDGMENTS .....	iv
SECTION I- IMPLEMENTATION.....	1
EXECUTIVE SUMMARY by Charles F. Willis.....	3
REPORT A. <i>Implementation of a tribal <b>longline</b> fishery for northern squawfish in <b>Bonneville</b>, <b>The Dalles</b> and John Day Reservoirs</i> by Christine Mallette and Charles F. Willis.....	9
REPORT B. <i>Evaluation of the northern squawfish sport-reward fishery in the Columbia and Snake Rivers</i> by Craig C. Burley, Daniel C. Klaybor, Greg W. Short and Gregory J. Hueckel.....	41
REPORT C. <i>The use of controlled angling to manage northern squawfish populations at <b>selected</b> dams on the Columbia and Snake Rivers</i> by Roy E. Beaty, Blaine L. Parker, Ken Collis, and Kathy <b>McRae</b> .....	111
REPORT D. <i>Evaluation of harvest technology for squawfish control in Columbia River Reservoirs</i> by Stephen B. Mathews, T.K. Iverson, J.M. Lynch, B.D. Mahoney and R.W. Tyler.....	187
REPORT E. <i>Feasibility of various techniques for removal of northern squawfish at Bonneville Dam, Columbia River</i> by Bruce Monk, William D. Muir and Paul Bentley.....	285
REPORT F. <i>Northern squawfish reward program, 1991 annual report</i> by Pam Kahut, Liza Bauman and Al Di di er.....	327
SECTION II- EVALUATION.....	333
EXECUTIVE SUMMARY by Anthony A. Nigro.....	335
REPORT G. <i>Development of a system-wide predator control program: indexing, fisheries evaluation, and harvesting <b>technology development</b></i> by David L. Ward, Mark P. Zimmerman, Robert M. Parker, and Scott S. Smith.....	343
REPORT H. <i>Economic, social, and <b>legal</b> feasibility of commercial, sport, and bounty fisheries on northern squawfish</i> by Susan Hanna, Jon <b>Pampush</b> , Michael Morrissey, and Dongdong Lin.....	435
REPORT I. <i>Columbia River Ecosystem Model (<b>CREM</b>)-- modeling approach for <b>evaluation of control</b> of northern squawfish <b>populations</b> using fisheries <b>exploitation</b></i> by Lewis J. Bledsoe, Helen Rudd, and Anderson F. Johnston.....	581

## **ACKNOWLEDGMENTS**

We thank Kevin Leader for his enthusiasm and diligence in coordinating the final preparation of manuscripts and assembling this extensive report.

SECTION I- IMPLEMENTATION

Cooperators

Oregon Department of Fish and Wildlife- Columbia River Coordination Section  
Washington Department of Wildlife  
Columbia River Inter Tribal Fish **Commission**  
University of Washington  
National Marine Fisheries Service  
Pacific States Marine Fisheries Commission



## EXECUTIVE SUMMARY

We report our results from the first year of a basin-wide program to harvest northern squawfish in an effort to reduce mortality due to northern squawfish predation on juvenile salmonids during their emigration from natal streams to the ocean. Earlier work in the Columbia River basin suggested predation by northern squawfish on juvenile salmonids may account for most of the 10 to 20 percent mortality juvenile salmonids experience in each of eight Columbia and Snake river reservoirs. Modeling simulations based on work in John Day Reservoir from 1982 through 1988 indicated it is not necessary to eradicate northern squawfish to substantially reduce predation-caused mortality of juvenile salmonids. Instead, if northern squawfish were exploited at a 10 to 20 percent rate, reductions in their numbers and restructuring of their populations could reduce their predation on juvenile salmonids by 50 percent or more. Consequently, we designed and tested a sport reward hook-and-line fishery and a **longline** fishery in the John Day pool in **1990**. Based on the successfulness of these limited efforts, we implemented three test fisheries on a multi-pool or system wide scale in **1991**: a tribal **longline** fishery, a sport reward fishery, and a dam angling (hook-and-line) fishery. In addition, we examined several alternative harvest techniques to determine their potential for use in system-wide test fisheries. Evaluation of the success of the three test fisheries conducted in **1991** in achieving a 20 percent exploitation rate on northern squawfish, together with information regarding the economic, social, and legal feasibility of sustaining each fishery, is presented in Section **II** of this report..

The implementation team includes the Oregon Department of Fish and Wildlife Columbia River Coordination Section (ODFW-CRC), Washington Department of Wildlife (WDW), Columbia River Inter Tribal Fish Commission (CRITFC), University of Washington (UW), National Marine Fisheries Service (NMFS), and Pacific States Marine Fisheries Commission (PSMFC). ODFW-CRC is responsible for coordination and administration of the entire program and has sub-contracted various tasks and activities to WDW, CRITFC, UW, NMFS, and PSMFC based on expertise each brings to the tasks involved in implementing the program. Objectives of each cooperator related to fishery implementation are as follows:

1. ODFW-CRC (Report A): Implement a tribal **longline** fishery in the tribal fishing area (Zone 6) located between Bonneville and **McNary** dams.
2. WDW (Report B): Implement a system-wide sport reward fishery.
3. CRITFC (Report C): Implement a system-wide angling fishery at eight **mainstem** Snake and Columbia river dams.
4. UW (Report D): Examine several alternative harvest techniques to determine their utility for harvesting northern squawfish in **mainstem** reservoirs of the Snake and Columbia rivers.
5. NMFS (Report E): Examine several alternative harvest techniques to determine their utility for harvesting northern squawfish at **mainstem** dams on the Snake and Columbia rivers.

6. PSMFC (Report F): Process and provide accounting for reward payments and compensation payments to participants in the sport reward and tribal **longline** fisheries, respectively.

Background and rationale for the study can be found in Report A of our 1990 annual report (Vigg et al. 1990).

Highlights of results of our work by report are:

#### Report A

1. Low level of tribal participation in the **longline** fishery accounted for the low observed catch of northern squawfish in 1991. Tribal fishers harvested a total of 1,625 squawfish with a catch rate of 0.124 fish per hour. Catch, effort and catch rate increased from May to June and then decreased through the end of the season. Northern squawfish catch rates for Bonneville, The Dalles and John Day reservoirs were 0.088, 0.195 and 0.193 fish per hour, respectively.
2. A post-season interview with tribal fishers revealed that they preferred a longer fishing season, the right to choose their own fishing locations and times, reimbursement for fishery startup and operating costs in addition to a per-fish remuneration, and less oversight. They felt these changes would increase participation in the **longline** fishery program and increase catch rate by tribal members.
3. The incidental catch rate of non-target species increased slightly over those observed in 1989 and 1990. We believe this was due in part to the inexperience of fishers and to initially imposed restrictions on fishers regarding fishing locations. White sturgeon accounted for 22% of the total **longline** catch. The catch rate of white sturgeon decreased during the season in Bonneville Reservoir, presumably because of experience gained by the fishers. Fishers in John Day Reservoir fished primarily near McNary Dam **tailrace** where high concentrations of white sturgeon occur, and **bycatch** of white sturgeon remained high throughout the season. We believe that the incidental catch of white sturgeon could be significantly decreased if baited hook sets are kept in the upper and mid-range of the water column by adding more floats to each **longline** set and attaching hook sets only on mainline areas that are away from anchors and weights.
4. Fishers used many variations of gear deployment. Most **longline** sets were deployed in McNary Dam **tailrace** or in Bonneville Dam **forebay**. Variation occurred in **longline** length, in hook-set spacing, in number of anchors and floats per **longline** set, and in baits and lures used by fishers.
5. Frozen, salted smolts provided by ODFW and CRITFC were the most frequently used and most effective bait. Unfortunately, bait quality was less than desirable. The overall **longline** northern squawfish catch rate might have been higher if higher quality bait had been available.
6. Tribal **longline** fishers participated in the fishery only during periods of optimal weather and river conditions during 1991. Poor weather and river

conditions contributed to low levels of fishing effort. Increased incentives could help reduce some impacts of marginal weather conditions on the participation level of fishers.

7. Levels of participation in the tribal **longline** fishery must be substantially increased if future fisheries are going to be able to contribute meaningfully to northern squawfish harvest. The patterns of catch observed during **1991** suggest that a mid-May to mid-August fishery might provide the most effective and economical tribal **longline** fishing program. Availability of registration sites and opportunities should be based on demand. Tribal fishers should be reimbursed for their daily travel and basic fishing expenses in addition to a per-fish reward. The reward per northern squawfish caught should provide tribal fishers with a reasonable profit margin. Observation of a fisher's activities by ODFW personnel should be advantageous to the fisher through services provided to observed fishers which are unavailable to unobserved fishers. An example would be issuing of a payment voucher to the fisher and transfer of the catch to ODFW without the fisher having to return to a central ODFW registration and fish collection site. The fishing season should not overlap with any alternative (e.g. sturgeon or salmon) fisheries. High quality smolts for bait should be made available to fishers throughout the season.

#### Report B

1. We conducted the northern squawfish sport-reward fishery from May 24 through September 22, **1991**. Nine check station sites were opened on May 24 with an additional six check stations opened July 15, **1991**. A total of 33,566 participants registered to fish for northern squawfish at the check stations. The returning anglers expended a total 24,186 angler days or 144,710 angler hours. A total of **159,162** northern squawfish **11** inches or longer were harvested.

2. Of the participants that registered, 41.13% returned after their fishing trip. The impacts of non-returning registered participants (58.87%) on other species of fish were not determined. A roving angler survey will be used in **1992** to assess **bycatch** associated with this fishery.

3. Results from **1991** suggest that in future seasons check stations should be opened from 9:00 a.m. to 9:00 p.m. Anglers should be allowed to fish 24 hours a day, and self registration should be available during those periods when the registration site is closed. Registration and exit interviews could be computerized to hasten processing time and improve data accuracy. We recommend that the check station located at Chief Timothy State Park be relocated to Boyer Park and that additional new check stations be provided in the Tri-Cities, Portland/Vancouver, and the Longview/Rainier areas.

#### Report C

1. During **1991**, anglers removed 39,705 northern squawfish from eight dams. Angler success varied considerably between dams and through time. In **1990**, ODFW anglers fished at five of the eight dams on the Columbia and Snake Rivers. The average seasonal catches per angler hour (CPAH) in **1990** at



Bonneville, The Dalles and John Day Dams were lower than those observed in **1991**.

2. The most productive period for dam angling on the lower Columbia was generally from June through mid-August. However, the best catch rates at John Day Dam occurred from August to early September. Patterns in CPAH observed this year may have been influenced by this year's unusually late, cool spring.

3. Dams on the Snake River did not have the mid-summer peak in CPAH that was common on the Columbia River. Variations in the CPAH might have been due to factors such as reduced abundance of prey passing the dams, waning angler enthusiasm, or reduced squawfish density.

4. For all dams combined, 3,414 fishes (total catch) were of incidentally taken species. We observed large differences in catch of incidental species between dams. Incidental catch rates ranged from 0.6% to **38%**, decreasing at dams farther upstream on the Snake River and at dams farther downstream on the Columbia River. Salmonids comprised less than **1%** of the total catch at each dam and only 3 to 4% of those caught were critically injured.

#### Report D

1. Purse seining is not an effective method for catching squawfish. Wind, current and underwater obstruction were major problems. Northern squawfish either do not school sufficiently for seining to be effective or they are adept at avoiding the seines. Catch rates average were less than one squawfish per seine set.

2. Merwin trapping in The Dalles Dam cul-de-sac was relatively productive averaging 50 to **100** northern squawfish per day. The trap was low in cost and required minimal effort to fish. Incidental injury and mortality to fishes captured in the trap were minimal. Mobile merwin traps need to be developed which can be used in a wider variety of areas throughout the Columbia & Snake rivers.

3. Other methods of squawfish removal should be investigated. Electrofishing may be an effective alternative harvest method. The predator indexing crews have consistently had a high northern squawfish catch per unit effort (CPUE) using electrofishing boats. However, the potential for harvesting squawfish on a large scale and the incidental harm to other species must be carefully examined.

#### Report E

1. A variety of techniques for removing northern squawfish from the Columbia River at Bonneville Dam were evaluated in **1991**. None of these removal techniques provided effective. Capture of northern squawfish with both permanently installed and portable electrode arrays was low throughout the sampling period. Previous studies by ODFW indicated that there was an inverse relationship between spill and northern squawfish abundance in the **forebay** at Bonneville Dam First Powerhouse. Spill rates were high at Bonneville Dam during **1991**. This may have contributed to our low northern squawfish catches.

2. Test of continuous multi-lure longlining gear resulted in an average catch of 2.9 northern squawfish per hour at Bonneville Dam First Powerhouse. Although the multi-lure **longline** gear did catch northern squawfish, it appears less effective than traditional hook and line methods. Catch per fisherman never exceeded that of dam anglers using a hook & line. Continuous multi-lure longlining is too labor-intensive and ineffective to warrant further testing.

3. Purse seining harvested only 134 squawfish in 17 sets. Incidental catches of American Shad were substantial, with estimates occasionally approaching 5,000 fish per set. Fish may have sounded or left the areas adjacent to the turbines that were shut down to allow fishing of the seine. Modification of purse seining equipment to allow rapid closure of the bottom during pursing may improve catch results if fish are escaping by sounding.

#### Report F

1. A total of \$466,549 was paid for northern squawfish in the 1991 sport reward fishery. During the season, 12,222 sport reward vouchers accounted for 155,334 northern squawfish caught. Payment of vouchers generally went smoothly. However, some math errors in completing vouchers or data entry errors in processing vouchers lead to some over payments.

2. Payment activity was heaviest during July and August accounting for 62% of all vouchers received and 70% of total northern squawfish caught. In July, 4,539 vouchers consisting of 71,597 northern squawfish were received and in August 3,069 vouchers with 36,385 northern squawfish were received.

3. A problem was encountered during payment of 1991 sport reward vouchers when some addresses and social security numbers in the ODFW data tapes proved to be in error. It became necessary to modify our computer program to check for duplicate vouchers within the ODFW data records. This was successfully accomplished.

4. A total of \$3,952 was paid for 988 northern squawfish documented in 98 tribal **longline** fishery vouchers. Payment activity was heaviest during June and July when 67% of the total voucher payments representing 84% of the total northern squawfish catch by **longline** fishers occurred.



REPORT A

Implementation of a Tribal **Longline** Fishery for Northern Squawfish in  
Bonneville, The Dalles and John Day Reservoirs

Prepared by

Christine Mallette and Charles F. Willis

Oregon Department of Fish and Wildlife  
Columbia River Coordination Section  
17330 SE Evelyn Street  
Clackamas, OR 97015



## CONTENTS

	<u>Page</u>
ACKNOWLEDGMENTS .....	13
ABSTRACT .....	14
INTRODUCTION .....	15
METHODS .....	15
RESULTS .....	17
Participation .....	17
Northern Squawfish Catch Rate and Distribution .....	18
Incidental Catch .....	21
Gear Deployment and Effectiveness .....	22
Weather and River Conditions .....	26
DISCUSSION .....	26
RECOMMENDATIONS FOR 1992 .....	30
REFERENCES .....	31
APPENDIX .....	33



## **ACKNOWLEDGMENTS**

This project was funded by Bonneville Power Administration, William Maslen, Project Manager (Contract #DE-BI79-90BP07084).

Anthony A. Nigro, ODFW Columbia Dam Studies Program Leader initiated the contract administration.

We thank Stephen B. Mathews and Tom K. Iverson, University of Washington, Susan Hanna and Jon **Pampush**, Oregon State University, and David L. Ward and his staff, ODFW Predator Control Evaluation Study, for their help with project coordination. We extend our thanks to Raymond C. Beamesderfer and staff, ODFW White Sturgeon Study, Suzanne M. Knapp, ODFW Umatilla Passage Study, and the staff of the Inter Tribal Enforcement Agency in Hood River, OR for their cooperation and assistance.

Special thanks to Matthew M. Marshall and Tamara L. **McGuire**, ODFW Predator Control Implementation Project, who helped oversee field operations and assisted with various tasks for preparation of the Annual Report, including data organization and summary, typing and drafting. We thank Paige M. Pierce who helped to review the manuscript. Twenty other seasonal employees conducted data collection and monitoring of the fishery.



## ABSTRACT

We are reporting progress on implementation of a subsidized commercial fishery for northern squawfish (*Ptychocheilus oregonensis*). The purpose of this fishery is to provide an alternative predator removal method to a public recreational reward fishery and an agency operated hook and line fishery conducted at and around hydro-power plants in areas that are restricted to the public. We created an opportunity for locally active tribal fishers to participate in the Predator Control Program through commercial harvest of northern squawfish using **longline** gear.

The fishery was conducted in the Bonneville Reservoir from May 1, **1991** to September 29, **1991**. Beginning June 20, **1991** and continuing through the end of the season, the fishery was expanded to include The Dalles and John Day reservoirs. All fishers were members of the four treaty tribes, including

- The Confederated Tribes Of The Warm Springs Reservation Of Oregon,
- The Confederated Tribes And Bands Of The Yakima Indian Nation,
- The Confederated Tribes Of The Umatilla Indian Reservation, and
- The Nez **Perce** Tribe Of Idaho;

and were recruited and equipped with **longline** gear by staff of the University of Washington (UW).

Tribal fishers' participation was much lower than had been anticipated prior to initiation of the fishery. Of thirty individuals who expressed interest in the fishery, only nine accepted installation of **longline** gear on their boats. In addition, only four fishers participated with regularity (i.e., for more than one week) during the fishing season.

Fishing activities were monitored by Oregon Department of Fish and Wildlife (ODFW). We collected data regarding catch, effort, incidental catch, fishing location, climatic conditions and deployment of the gear.

Tribal fishers harvested a total of 1,625 fish. Northern squawfish comprised 66% of the total catch (1,071 fish) and were caught at a rate of 0.124 northern squawfish per hour fished or one northern squawfish per 34.65 hook sets. Nearly all incidentally caught species were released alive. White sturgeon comprised 22% of the total catch (359 fish). The disposition of all but three sturgeon (ranging 18 to 36 inches in fork length) was good at the time of release. All but three sturgeon were less than 40 inches in fork length.

## INTRODUCTION

Impoundments that were created by the development of the Columbia River basin hydroelectric system delay the downstream migration of juvenile salmon and steelhead and prolong their exposure to predators (Raymond 1988). Resulting habitat changes have enabled some species of predacious, resident fish to become established and increase substantially in abundance. Northern squawfish were found to be the most abundant predator (Beamesderfer and Rieman 1988). Predation is an important component of reservoir mortality of juvenile salmonids in the Columbia River system, and can account for about 80% of total losses (Rieman et al. 1988). Results from modeling have suggested that a sustained 20% exploitation of the northern squawfish population by fisheries could reduce the juvenile **salmonid** losses to predation by 50% (Rieman and Beamesderfer 1990).

Previous studies have been conducted from 1988 to 1990 in the Columbia River basin to develop a step-wise process for the systematic implementation and evaluation of various fisheries on northern squawfish.

From April through August 1989 **longline** gear was tested in the John Day Reservoir for applicability to small boat, commercial harvest (Mathews et al. 1989). The use of monofilament groundlines, **3/0** hooks, and **salmonid** smolts for bait was found to be most effective. Catches averaged one northern squawfish per 12 baited hook sets. Total catch was comprised of 72% northern squawfish, 23% white sturgeon and 5% other species.

From June through August 1990 a small scale commercial **longline** test fishery was implemented in the John Day Reservoir (Mathews and Iverson 1990). ODFW contracted with three tribal fishing vessels, and UW equipped them with gear and bait. Catch rates were lower than expected based on 1989 results and depended on fishers' skill level, the amount of effort that individual crews were able to apply, water temperature and the type of bait used. Catches averaged one northern squawfish per 22.5 hook sets. Total catch was comprised of 73% northern squawfish, 15% white sturgeon and 12% other species. Following the 1990 season, it was suggested that longlining opportunities should be made available in 1991 to all tribal fishers who wished to participate in order to determine the effectiveness of this method of predator removal when applied on a larger scale (Mathews and Iverson 1990). Therefore, during the 1991 season all treaty tribe members were eligible for participation in the fishery.

## METHODS

The northern squawfish **longline** fishery was implemented in the Bonneville Reservoir starting May 1, 1991. On June 20, 1991 the fishery was expanded into The Dalles and John Day reservoirs, thus encompassing all three pools known as management Zone 6 on the Columbia River. **Longline** fishing was conducted Wednesday through Sunday, 7AM through **9PM**. The fishery was closed on Mondays and Tuesdays. The last fishing day was September 29, 1991.

UW staff members outfitted interested fishers with gear and, if desired, instructed them on gear deployment. A total of nine fishers and 25 crew members participated.

Fishers were required to register at one of our five registration sites prior to pulling and resetting their longlines. Registration sites (Fig. C-1) were located as follows:

- Bonneville Pool
  - Port of Cascade Locks in Cascade Locks, OR and
  - Port of Klickitat in Bingen, WA;
- The Dalles Pool
  - Celilo Park, OR;
- John Day Pool
  - **LePage** Park, OR and
  - Port of Umatilla in Umatilla, OR.

Fishers were given a logbook and instructions for its use. At the registration sites, fishers provided ODFW staff with information regarding the location, time, number of lines, and number of hooks in a particular set. This information was recorded on a registration form (Fig. C-2). Fishers were also informed at that time if an ODFW observer was to be placed on board.

After pulling their **longline** sets, fishers returned to the station where they registered to participate in an exit interview, to check in their catch, and to receive a voucher. ODFW personnel issued a voucher equal to four dollars for each northern squawfish that was fresh and greater than eleven inches in total length (Fig. C-3).

The exit interview yielded information regarding the amount of time spent in preparation; total time on the water; and economic data regarding the costs of gasoline, bait, ice, maintenance, etc., per fishing trip.

Fishers turned in copies of their logbook entries with their catch. Each logbook page represented one **longline** set and contained information about northern squawfish and incidental catch, type of bait used, time spent working with the gear, and **longline** location and length (Fig. C-4). Fishers were also asked to record or report comments, complaints and suggestions about the trip and the project in general.

After concluding the exit interview and issuing the voucher, ODFW personnel collected biological data on all northern squawfish that were turned in by the fishers. Fork length, weight, disposition, sex, maturity, and noticeable marks were recorded on a biological data form (Fig. C-5). Scale samples and any tags were collected, as was roe from ripe female northern squawfish. Caudal fins were clipped to indicate processing had occurred. Fish were then stored in chest freezers at local field stations until collection for utilization by Oregon State University (OSU) personnel.

Fishing trips were randomly observed either by an ODFW observer, who met the fisher at the registration site and accompanied the fisher on the boat, or from a distance by crew members of an ODFW observation vessel. Observers recorded the fishing location, time of day, time spent fishing, weather conditions, turbidity, water surface temperature, and deployment of the fishing gear on an observation form (Fig. C-6). Fork length, disposition and tag information of incidentally caught species were also recorded prior to their immediate release.

In a co-effort with UW an in-season phone interview with all recruited fishers was conducted. The sufficiency and effectiveness of issued **longline** gear and bait was surveyed. Fishers were also asked about their perception of the Predator Control Program and in particular about implementation procedures of the tribal **longline** fishery. In addition the phone survey was to determine if the reward of four dollars per northern squawfish caught was an adequate reimbursement for the fishers' effort.

## RESULTS

### Participation

Tribal fishers' participation in the 1991 northern squawfish tribal **longline** fishery was disappointingly low. Estimates of participation that were calculated as part of the 1990 Annual Report indicated that over 400 treaty tribe members were eligible for this fishery (Vigg et al. 1990). Although the fishery was announced several months prior to its start, only 30 individuals showed an interest in the project and were recruited by UW staff. Nine fishers actually participated, and only four fished with **longline** gear for more than one week.

Reasons for the lack of participation in the fishery were investigated. An in-season interview that was conducted with the recruited fishers revealed that unfamiliarity with locations of northern squawfish concentrations and with **longline** gear resulted in low catch rates. Fishers felt that the monetary reimbursement of four dollars for each northern squawfish caught which we offered in 1991, was too low to cover all fishing trip expenses (approximately \$50 to \$100 per day) as well as provide for a profit given the catch rates observed in 1991. Bothersome registration procedures and a heavy rate of ODFW observation were other reasons given for lack of participation in the fishery.

A total of 118 fishing trips were made in 1991 (Table C-1). Over the entire season most fishing trips occurred in the Bonneville Reservoir (68% or 80 trips). The overall number of fishing trips per month remained approximately the same from May to July with an apparent drop off in August and no participation in September. As the season progressed, there was a decrease in the number of fishing trips occurring in Bonneville Pool and an increase in the number of trips occurring in John Day Pool. In John Day Reservoir, fishing effort was focused mainly in July (24 trips).

Due to the low tribal fishers' participation, a very high observation rate was achieved. Seventythree trips or 62% of the total number of fishing trips that were made throughout the season were sampled.

Table C-1. Total Number of Fishing Trips and Number of Observed Trips by Month and Reservoir

Month	Reservoir							
	Bonneville		The Dalles		John Day		Total	
	#Total	#Observ.	#Total	#Observ.	#Total	#Observ.	#Total	#Observ.
May	32	23	0	0	8	7	32	23
June	27	16	3	0	24	14	30	23
July	10	4		1				19
August	11	5	1	1	2	2	14	8
September	0	0	0	0	0	0	0	0
Total	80	48	4	2	34	23	118	73

#### Northern Squawfish Catch Rate and Distribution

Tribal fishers harvested a total of 1,625 fish. Northern squawfish comprised 66% of the total catch (1,071 fish) in 1991, as compared to 72% in 1989 (Mathews et al 1989) and 73% in 1990 (Mathews and Iverson 1990).

The overall catch rate of northern squawfish in 1991 was 0.124 fish per hour (Table C-2). Catch, effort, and catch rate increased from May to June, remained high during June and July, and decreased through August. Fishers made no attempt to fish during September.

Table C-3 presents the catch of northern squawfish by month and reservoir. While only 34% of the total fishing effort was expended in the John Day Pool, this effort accounted for 52% of the total catch of northern squawfish. John Day Reservoir yielded the highest CPUE values for each month during the period in which it was open for fishing.

Table C-2. Northern Squawfish Catch, Effort, and Catch Rates (CPUE) by Month

Month	# Fish Caught	# Hours Fished	CPUE
May	72	1,139.1	0.063
June	526	2,726.1	0.193
July	366	2,574.9	0.142
August	39	1,623.4	0.024
September	0	0	
Total	1,003	8,063.5	0.124

Table C-3. Northern Squawfish Catch, Effort, and Catch Rates (CPUE) by Month and Reservoir

Month	Reservoir								
	Bonneville			The Dalles			John Day		
	#Fish	#Hours	CPUE	#Fish	#Hours	CPUE	#Fish	#Hours	CPUE
May	309	2,066.3	0.068	0	8	0.082	217	651.8	0.329
July	52	636.4	0.082	12	39	1.051	302	1,899.5	0.159
August	32	1,441.8	0.022	1	27.5	0.036	6	154.1	0.039
September	0	0		0	0		0	0	
Total	465	5,283.6	0.088	13	66.5	0.195	525	2,713.4	0.193

In addition to the data presented in Table C-3, 59 northern squawfish that were greater than 11 inches in total length were taken without effort information. Nine additional northern squawfish were reported as caught but measured less than 11 inches in total length, bringing the total catch of northern squawfish to 1,071.

During the first seven weeks the fishery was implemented in Bonneville Reservoir only. On June 20, 1991 the fishery was expanded into The Dalles and John Day reservoirs. At this time, one fisher who had previously fished in the Bonneville Reservoir transferred to the John Day Reservoir. All other fishers fished only one pool throughout the entire season.

Catch and effort for Bonneville Reservoir decreased significantly from June to July, reflecting in part the transfer of the above mentioned, relatively successful, fisher.

Fishers showed very little interest in fishing The Dalles Reservoir. Only one fisher fished this pool during the 1991 season. Due to the very small sample sizes, the CPUE results may be misleading.

A total of 426 **longline** sets were set (Table C-4). Most of them (66%) were set during June and July. The highest catch rates per **longline** set also occurred during those months. The numbers of **longline** sets deployed in May and in August are almost identical, although the catch per **longline** set is approximately three times higher in May. For the entire season the northern squawfish catch averaged 2.51 fish per **longline** set. This exceeds the average catch of 1.85 fish per **Longline** set (Mathews and Iverson 1990) observed during the 1990 test fishery. However, the mean **longline** length was approximately twice as long in 1991 as in 1990.

Table C-4. Northern Squawfish Catch, Effort, and Catch Rates per Longline Set by Month

Month	# Fish Caught	# Longline Sets	# Fish per Set
<b>May</b>	<b>100</b>	72	<b>1.39</b>
June	532	150	3.55
July	400	133	3.01
August	39	71	0.55
September	0	0	
Total	1,071	426	2.51

Most **longline** sets (267, or 63%) were set in Bonneville Reservoir (Table C-5). Approximately half that number (153) of **longline** sets were set in John Day Reservoir. Over the entire season, catch per **longline** set in John Day Reservoir was more than twice as high as it was in Bonneville Reservoir.

Concurring with **longline** set data, most hook sets (67%) were deployed during June and July. The number of hook sets per northern squawfish caught was smallest for those months as well (Table C-6). Over the entire season, catch averaged one northern squawfish per 34.65 hook sets, thus being low compared to results for 1989, when catch averaged one northern squawfish per 12 hook sets (Mathews et al 1989), and 1990, when catch averaged one northern squawfish per 22.5 hook sets (Mathews and Iverson 1990). The highest number of hook sets (101.33) per northern squawfish caught in the 1991 fishery was reached during August.

Table C-5. Northern Squawfish Catch, Effort, and Catch Rates per Longline Set by Month and Reservoir

Month	Reservoir								
	Bonneville			The Dalles			John Day		
	#Fish	#Sets	Fish/Set	#Fish	#Sets	Fish/Set	#Fish	#Sets	Fish/Set
<b>May</b>		<b>72</b>	<b>1.39</b>	0	<b>0</b>	<b>0</b>		<b>0</b>	<b>0</b>
<del>May</del>	<b>323</b>	<b>126</b>	<b>0.89</b>	0	<b>0</b>	<b>0</b>	<del>210</del>	<b>44</b>	<del>4.93</del>
July	<b>32</b>	<b>63</b>	<b>0.51</b>	41	5	8.20	336	102	<b>3.29</b>
August				1	1	1.00	6	7	0.86
September	0	0	0	0	0	0	0	0	0
Total	470	267	1.76	42	6	7.00	559	153	3.65

Table C-6. Northern Squawfish Catch, Effort, and Catch Rates per Hook Set by Month

Month	# Hook Sets	# Fish Caught	# Hook Sets per Fish
May	8,347	100	83.47
June	14,957	532	28.12
July	9,856	400	24.64
August	3,952	39	101.33
September	0	0	
Total	37,112	1,071	34.65

Over the entire season, two and a half times as many hooks were set in Bonneville Reservoir as in John Day Reservoir (Table C-7). However, only 22.57 hook sets were needed to catch one northern squawfish in the John Day Reservoir during the month of July, whereas roughly four times as many (83.65 hook sets), were needed during the same month to catch one northern squawfish in Bonneville Reservoir. During June, more than three times as many hooks were needed in Bonneville Reservoir than in John Day Reservoir to catch one northern squawfish, although fishers were only able to fish in the John Day Reservoir for the last one third of the month.

Table C-7. Northern Squawfish Catch, Effort, and Catch Rates per Hook Set by Month and Reservoir

Month	Reservoir								
	Bonneville			The Dalles			John Day		
	#Hooks	#F.	#H. /F.	#Hooks	#F.	#H. /F.	#Hooks	#F.	#H. /F.
May	18,257	306	88.97	0	0		2,700	217	12.44
June	1,924	23	83.65	350	41	8.54	7,582	336	22.57
July	3,472	32	108.50	100	1	100.00	380	6	63.33
August	0	0		0	0		0	0	
September									
Total	26,000	470	55.32	450	42	10.71	10,662	559	19.07

Incidental Catch

A total of 554 fish were caught incidentally during the 1991 tribal longline fishery. White sturgeon comprised 22% (359 fish) of the total catch



of 1,625 fish, channel catfish comprised 6% (96 fish), walleye comprised 0.2% (3 fish) and various other species comprised 6% (96 fishes) of the total catch (Table C-8).

Table C-8. Incidental Catch and Percent of Total Catch by Species

Species	# Fish Caught	% of Total Catch
Sturgeon	359	22.2
Channel Catfish	96	5.9
Sucker		2.8
Sculpin	3	2.3
Chisel mouth	<b>6</b>	0.4
Walleye	<b>3</b>	0.2
Carp	3	0.2
Shad	2	0.1
<b>Peamouth</b>	2	0.1
Lamprey	1	0.1
Total	554	34.3

Most white sturgeon (82% of the total sturgeon **bycatch**) were caught during June and July (Table C-9), which were the months of heaviest fishing effort. Nearly the same number of white sturgeon were caught in Bonneville Reservoir (162 fish) as in John Day Reservoir (167 fish) even though approximately twice the fishing effort was expended in Bonneville Reservoir compared to John Day Reservoir (Table C-3). Catch rate of sturgeon decreased substantially in Bonneville Reservoir after June 1991.

We observed 158 white sturgeon or 44% of the total sturgeon **bycatch** (Table C-10) and measured fork length, collected data from tags and secondary marks, and determined their disposition. Of all observed sturgeon, **74%**, or 117 fish, measured 450-800mm (18-31 inches) in fork length. Only three sturgeon were greater than **1000mm** (40 inches) in fork length.

All but three white sturgeon were released in good condition. Two were in poor condition (**640mm**, July11 and **460mm**, July12), one was dead (**912mm**, August16).

#### Gear Deployment and Effectiveness

Of the total number of fishing trips (118) that were made during the 1991 season 62% were observed and it was noted in what way fishers used the **longline** gear. In particular it was described how and where the longlines were set, how far apart hook sets were placed on the mainline, and what types of bait and additional attractants were used.

Table C-9. Distribution of Incidentally Caught White Sturgeon and Catch Rates by Month and Reservoir

Month	Reservoir							
	<u>Bonneville</u>		<u>The Dalles</u>		<u>John Day</u>		<u>Total</u>	
	# Fish	CPUE	# Fish	CPUE	# Fish	CPUE	#Fish	CPUE
<b>May</b>	50	0.044	<b>0</b>	0	0	0	50	0.044
June	111	0.054	<b>29</b>	8	20	0.030	131	0.048
July	0	0		0.744	134	0.071	163	0.063
August	1	0.001	1	<b>0.036</b>	13	<b>0.084</b>	15	<b>0.009</b>
September	0	0	0	0	0	0	0	0
<b>Total</b>	<b>162</b>	<b>0.031</b>	<b>30</b>	<b>0.451</b>	<b>167</b>	<b>0.062</b>	<b>359</b>	<b>0.045</b>

Table C-10. Length Frequencies of Incidentally Caught White Sturgeon by Month and 50mm Length Increments

Length	Month					Total
	May	June	July	August	September	
<b>300- 350</b>		<b>0</b>	0	<b>1</b>		<b>1</b>
<b>350- 400</b>	8	<b>1</b>	2	<b>1</b>	8	<b>4</b>
<b>400- 450</b>	0	<b>2</b>	<b>6</b>	<b>0</b>	0	8
<b>451- 500</b>	<b>0</b>	<b>5</b>	<b>7</b>	<b>2</b>		<b>14</b>
<b>501- 550</b>	<b>0</b>	<b>6</b>	9	<b>2</b>	8	<b>17</b>
<b>551- 600</b>	<b>3</b>	<b>1</b>	8	<b>0</b>		12
<b>601- 650</b>	<b>6</b>	<b>2</b>	9	<b>1</b>	8	18
<b>651- 700</b>	7	<b>0</b>	<b>9</b>	<b>0</b>		<b>16</b>
<b>701- 750</b>	6	<b>1</b>	<b>11</b>	<b>3</b>	8	<b>21</b>
<b>751- 800</b>	<b>8</b>	<b>2</b>	6	<b>1</b>	0	17
<b>801- 850</b>	<b>6</b>	<b>0</b>	<b>2</b>	<b>0</b>	<b>0</b>	8
<b>851- 900</b>	<b>2</b>	<b>1</b>	<b>3</b>	<b>1</b>	<b>0</b>	<b>7</b>
<b>901- 950</b>	<b>8</b>	<b>0</b>	0	<b>2</b>	0	<b>10</b>
951-1000	1	<b>0</b>	1	<b>0</b>	0	2
1001-1050	1	<b>0</b>	1	<b>1</b>	0	3
Total observed	48	<b>21</b>	74	15	0	158
Not observed	<b>2</b>	<b>110</b>	<b>89</b>	<b>0</b>	0	201
Total caught	<b>50</b>	131	<b>163</b>	<b>15</b>	0	359

All but one fisher used the **longline** gear that was provided by UW. Nearly all longlines were set in the vicinities of Bonneville Dam **forebay** and **McNary** Dam tailrace.

Fishers used longlines ranging from 250 to 1800 feet and averaging 860 feet in total length. Of the total number of **longline** sets deployed 95% were single, unbranched lines set parallel to the shoreline. All **longline** sets were deployed between 4 and 80 yards off the shoreline, with the average distance to shore being 25 yards. 90% of the total number of **longline** sets were weighted on both ends. Some fishers used "floater" or Portuguese longlines weighted only at the upstream end.

Floating devices (i.e. corks, chunks of Styrofoam, milk jugs, etc.) were attached to 90% of the total number of **longline** sets to achieve buoyancy. If they were attached to Portuguese **longline** sets, the range of movement for baited hook sets in the water increased significantly. As the fishing season progressed, nearly all fishers used relatively more corks to elevate the longlines and therefore decreasing the incidental **bycatch** of white sturgeon, that was higher when longlines were set close to the river bottom.

The depth at which longlines were set varied between 5 and 30 feet below the water surface. In general fishers set their longlines while navigating downstream and retrieved them while motoring upstream.

The most commonly used hook set was comprised of a **3/0** stainless steel hook with an eleven inch **gangion** leader. The spacing of hook sets, or the length of mainline between two hook sets, varied from less than one foot to 36 feet. Table **C-11** presents data on the number of **longline** sets using each type of hook set spacing employed during **1991**, along with the associated catch of northern squawfish for each type of set.

Table **C-11**. Number of **Longline** Sets by Type of Hook Set Spacing (in feet) and Associated Northern Squawfish Catch,

Spacing	#Longline Sets	#Fish Caught	Spacing	#Longline Sets	#Fish Caught
<1	2	4	12	3	3
1	1	0	15	1	4
2	22	19	17	2	20
3	43	60	18	1	2
4	43	56	19	6	14
5	23	51	20	11	41
6	36	57	21	10	28
7	2		22	13	33
8	18	1::	23	3	6
9	3		24	4	9
10	170	51:	29	2	2
11	2	5	36	1	2

<sup>a</sup>Two additional northern squawfish were caught on four additional long-line sets for which hook set spacing information was unavailable.

The most frequently used hook set spacing was ten feet (170 **longline** sets or 40% of the total number of **longline** sets). Nearly half of the total northern squawfish catch (**48%**, or 513 fish) was caught on **longline** sets with this hook set spacing. For 46% (193 sets) of the total number of **longline** sets (422 sets), the hook set spacing was less than ten feet. With those sets, 36% (387 fish) of the total northern squawfish catch (1,069 fish) was obtained. For 14% (59 sets) of the total number of **longline** sets, the spacing was greater than ten feet. With those sets, 16% (169 fish) of the total northern squawfish catch was obtained. These results suggest that eight to ten feet of spacing between hook sets was the most frequently used and most effective for **longline** gear targeting on northern squawfish.

UW recommended the use of frozen salted smolts as bait. However, fishers used a variety of bait and lures. Table C-12 depicts the types of bait used and related northern squawfish catch observed in **1991**.

Table C-12. Bait Used on **Longline** Sets and Associated Northern Squawfish Catch

Bait	<b>Longline Sets</b>		Squawfish Catch	
	#	%	#	%
Smolts	183	43	<b>791</b>	<b>74</b>
Mixed Bait	106	25		<b>14</b>
Worms	93	22	<b>100</b>	<b>10</b>
Shrimp	<b>14</b>	3	<b>13</b>	1
Lamprey	<b>11</b>	3	6	<1
Plastic Worms	9	2	<b>1</b>	
Shad	<b>4</b>	<1	<b>3</b>	<1
Plastic Grub	<b>3</b>	<1	2	<1
Crayfish	2	<1		
Lure	1	<1	<b>8</b>	
Total	426	<b>100</b>	<b>1,071</b>	<b>100</b>

Frozen, salted smolts and mixed bait, that consisted of some amount of frozen, salted smolts, were used on 68% of all **longline** sets. The majority of the northern squawfish catch (88%) was caught on those **longline** sets. **Longline** sets that were baited with worms (22% of all **longline** sets) accounted for **10%** of the total northern squawfish catch. All other types of bait and lures used with **longline** gear were much less effective, collectively accounting for approximately 2% of the total northern squawfish catch.

Some fishers added attractants such as fluorescent yarn (tied to the hook sets) and "chum buckets" (filled with decaying shrimp and sliced lamprey) to their **longline** sets.

## Weather and River Conditions

Categorized weather conditions were recorded for each observed fishing trip during the 1991 season. Table C-13 summarizes weather and river conditions in percent of the total number of observed fishing trips. Most **longline** sets were retrieved and reset while the weather was sunny, with N.W. wind, and a smooth river surface.

Table C-13. Categorized Weather and River Conditions for Percent of the Total Number of Observed Fishing Trips

Sun	Weather			Wind					River		
	Over-cast	Rain	Fog	N.W.	S.W.	N.E.	E	None	Smooth	Swells	
										<2ft	≥2ft
62	34	4	0	71	10	8	10	1	52	42	6

### DISCUSSION

Very few northern squawfish were harvested during the 1991 tribal **longline** fishery, both with respect to the numbers of northern squawfish caught in alternative fisheries and with respect to the cost for implementing the tribal **longline** fishery. The very low level of tribal participation in the **longline** fishery was a major contributing factor to the low observed catch.

Following the 1990 **longline** test fishery, UW conducted an exit interview with participating tribal fishers to obtain their ideas on how future fisheries could be improved. In particular, fishers suggested that the fishery be implemented from May through September, rather than for a constrained fishing period from Mid-June through Mid-August as in 1990. Also, they preferred to choose fishing locations, and times rather than having to fish according to a schedule established by ODFW.

Although we incorporated those suggestions into the design of the 1991 fishery, other factors apparently contributed to the low level of participation observed. Most fishers that were recruited into the fishery were unfamiliar with fishing locations where northern squawfish could be found, and with the use of **longline** gear. This led to relatively high start up expenses and low catch rates. The reward that ODFW offered to tribal fishers for their catch was not sufficient to cover the fishers' expenses at the catch rates they could achieve early in the season. Furthermore, the catches of two experienced fishers who had participated in the 1990 test fishery were still not large enough to allow for a reasonable profit.

Previously conducted studies suggested that a monetary reimbursement of four dollars per northern squawfish would be adequate to sustain a tribal commercial fishery. These findings were based on catch rates that were

achieved in **1989** and **1990**. However, overall catch rates observed in **1991** were much lower. Analyses of economic factors regarding the tribal **longline** fishery (currently underway by OSU) will help us to better understand the adequacy and effectiveness of the reward which was offered to tribal fishers in **1991**.

It is essential to the sustainability and success of the **longline** fishery that implementation costs decrease and that the fishers' interest in the fishery, and thus participation, increases.

In **1991** ODFW registration clerks and observers were present at five registration sites Wednesdays through Sundays, from 7AM to **9PM**. Fixed personnel costs of the fishery were relatively high and fishers rarely used these registration services. In order to reduce implementation expenses of future fisheries, the availability of registration and observation opportunities should be flexible and based on demand. For example, fishers could register with ODFW by phone the day before a fishing trip, allowing placement of observers on a random basis. If registration took place at a field office rather than at an access site (i.e. boat ramp) as in **1991**, registration personnel could be performing data entry and various other office duties while waiting for registrants to call. In addition, restricting the registration period to several (i.e. four) hours per fishing day would reduce the total number of hours worked by ODFW staff and could increase the cost efficiency of the fishery significantly.

A **1991** in-season interview suggested that a reimbursement for a fishers' basic start up and operating costs (i.e., for gasoline, bait, etc.) in the form of a daily salary or wage could increase fishers' interest in the fishery significantly. This would allow all fishers to participate in the fishery on a test basis without prohibitive financial consequences, and could result in higher long-term participation and, ultimately, higher catch rates. This daily wage should be set at a level which is just high enough to cover operating expenses. A reward per northern squawfish caught (equal to that given for a sport caught northern squawfish) should be used as a profit incentive to encourage active harvest effort.

Fishers in **1991** also indicated that the heavy rate of ODFW observation (62%) was a deterrent to participation, because fishers felt that they were not trusted. By using a system such as described above to provide flexibility in assigning observers, the observation level could be adjusted to that which is appropriate regardless of the number of fishers registering to fish each day. Further, incentives could be provided to fishers with observers aboard in terms of processing their catch, issuing a reward voucher to them, and transporting their catch for them to a registration site. This would save the observed fishing party additional travel time and costs associated with bringing their catch to a registration site for processing.

Although most tribal **longline** trips throughout the entire season occurred in Bonneville Reservoir, there was a shift of effort from that pool to **John Day Reservoir**, which occurred when the latter pool was opened to fishing in late June **1991**. This may suggest a preference among tribal fishers for fishing in John Day Pool.

The pattern of northern squawfish catch and catch rates observed over the **1991** season suggests that a mid-May through mid-August fishery would encompass

most or all of the effective **longline** fishing period. This would avoid low catch rates associated with low water temperatures in early May, and it would help to avoid scheduling conflicts with alternative fisheries occurring after mid-August.

The cost of implementing future tribal **longline** fisheries could be substantially reduced by limiting the scope of the fishery to a single pool above Bonneville Dam. Highest catch rates of northern squawfish in 1991, whether in terms of catch per hour, catch per **longline** set, or catch per hook set, occurred in the John Day Reservoir throughout the period during which this pool was open to the fishery. In terms of fishery productivity, and possibly tribal fishers' preference, the best single pool for implementation of the tribal **longline** fishery would be the John Day Pool.

#### Incidental Catch

With the exception of white sturgeon, the incidental catch rate of non-target species was relatively low (less than 6% per species).

In 1991, the proportion of white sturgeon **bycatch** (22% of the total catch) was higher than that observed in 1989 (11%) and in 1990 (15%), while the channel catfish **bycatch** (6%) was lower than in previous years (11% in 1989 and 10% in 1990). Catch rates for other incidentally caught species were slightly higher than in 1989 (Mathews et al. 1989) and in 1990 (Mathews and Iverson 1990).

These results reflect the importance of experience in avoiding sturgeon catch with **longline** gear while fishing for northern squawfish. The addition of new, inexperienced fishers to the 1991 fishery, and the initial restriction of fishing locations to Bonneville Reservoir which was untested for **longline** gear, contributed to the increase in **bycatch** of sturgeon observed in 1991 as compared with 1990. In-season results also suggest the benefit of experience in avoiding sturgeon **bycatch**. In Bonneville Reservoir, sturgeon catch rates decreased substantially after June, even though fishing effort remained high through August. This suggests that fishers in the Bonneville Reservoir learned how to reduce the **bycatch** of sturgeon during the latter half of the 1991 season.

Although nearly twice the total fishing effort was expended in Bonneville Reservoir as compared to the John Day Reservoir (which was not opened to fishing until late June), the **bycatch** of sturgeon in these two pools was nearly the same (162 and 167 respectively) over the entire season. Most fishers in the John Day Reservoir were participants of the 1990 test fishery and were, therefore, experienced. UW advised these fishers in 1990 to fish for northern squawfish throughout the water column. However, they tended to fish the river bottom more frequently than near the water surface, which resulted in a larger squawfish catch, and only a slight increase in incidental catch rates of white sturgeon during the 1990 season. Experienced fishers continued this fishing method during the 1991 season. However, in 1991 the incidental catch rate of white sturgeon increased significantly over that observed in 1990.

Experienced fishers also preferred to fish in the upper part of the John Day Reservoir and, in particular, close to the boat restricted zone (BRZ) of the **McNary Dam tailrace** in 1991. Current studies of white sturgeon

distribution in the Columbia River show that, within a given pool, sturgeon concentrations are highest in the upper part of a reservoir and, in particular, in dam **tailrace** areas (North et al. 1992). The combination of fishing location and method that fishers chose in John Day Reservoir during the 1991 season resulted in significantly higher sturgeon **bycatch** rates for John Day Reservoir compared with Bonneville Reservoir. Avoidance of areas with high sturgeon concentrations combined with altered fishing methods could decrease overall sturgeon **bycatch** rates significantly in future fisheries.

The white sturgeon **bycatch** was comprised almost entirely (98%) of fish less than 40 inches in fork length. The relatively light weight gear used in the 1991 northern squawfish **longline** fishery did not restrain most sturgeon over 40 inches in length. The large sturgeon simply break free if hooked. Likewise, the rate of injury to hooked sturgeon was extremely low (three fish, or 2% of the total sturgeon **bycatch**).

#### Gear Deployment and Effectiveness

Although fishers used many variations of gear deployment, they did not change fishing locations to a large degree. Most **longline** sets were deployed at McNary Dam **tailrace** or at Bonneville Dam **forebay**, with practically no effort in the mid-reservoirs.

Nearly all participating fishers varied **longline** length, hook set spacing, number of anchors and corks per **longline** set, and some fishers also used a variety of baits and lures. In general, fishers used shorter **longline** sets than the 1,200 feet **longline** that was recommended by UW. Nevertheless, fishers followed UW recommendations for hook set spacing and bait. Eight to ten feet of spacing between hook sets was recommended, and most effective, for **longline** gear targeting on northern squawfish.

Frozen, salted smolts were the most frequently used and most effective bait type with **longline** gear for capturing northern squawfish. Smolts were provided by ODFW and Columbia River Inter Tribal Fish Commission (CRITFC) at no cost to the fishers. Most fishers used this bait to some extent. The bait quality was questionable and may have contributed to the observed low catch rates. The overall northern squawfish catch rate for the tribal **longline** fishery might have been higher than observed, if a better grade of bait had been provided.

The availability of high quality bait is essential to the success of the tribal **longline** fishery. Fresh, flash-frozen smolts should be made available to the fishers at little or no cost. This could be achieved by centralizing the purchase, storage and distribution of bait, as part of the ODFW implementation process. Fishers could obtain bait from an ODFW field office during daily registration procedures.

During the 1990 test fishery, as discussed in more detail under Incidental Catch above, fishers preferred to set their longlines close to the river bottom where they caught more northern squawfish than in the upper and mid-range of the water column. Many continued to fish the lower range of the water column during the early 1991 season. Most fishers who caught a relatively high number of white sturgeon incidentally during the early 1991 season, however, used a significantly higher number of corks per **longline** set as the season progressed. This resulted in a decreasing sturgeon **bycatch** for



these fishers. Fishers who continued to fish only in the lower water column contributed significantly to the overall high sturgeon **bycatch** rate and, in particular, to the sturgeon **bycatch** rates for fishing locations in John Day Reservoir and close to the **McNary** Dam tailrace. We observed that once one sturgeon was caught incidentally, more sturgeon were likely to be caught on the same **longline** set. The **longline** set appeared to be pulled down by hooked sturgeon, increasing the vulnerability of additional sturgeon to the hook sets.

These observations suggest that the incidental catch of white sturgeon could be significantly decreased, if baited hook sets could be kept in the upper and mid-range of the water column by adding more corks to each **longline** set and attaching hook sets only on mainline areas that are away from anchors and weights.

#### Weather and River Conditions

Fishers only participated in the **1991** fishery on days that provided nearly optimal weather and river conditions. Poor weather and river conditions are clearly factors that contribute to low levels of fishing effort. An increased incentive in the form of a salary or wage for basic fishing expenses might help to reduce some impacts of marginal weather conditions on the participation level in future fisheries.

#### RECOMMENDATIONS FOR **1992**

- 1.) Availability of registration opportunities should be based on demand.
- 2.) Tribal fishers should be reimbursed on a daily basis for their travel and basic fishing expenses.
- 3.) The reward per northern squawfish caught should allow the fishers a marginal profit.
- 4.) Observation by ODFW personnel should be of some advantage to the fisher, i.e. less travel and time expenses.
- 5.) The fishing season should be shortened.
- 6.) The fishing season should not overlap with any sturgeon or salmon fisheries in the Columbia River.
- 7.) High grade smolts (fresh and frozen) should be available to the fishers for bait throughout the season.

## REFERENCES

- Beamesderfer, R. C., and B. E. Rieman. 1988. Predation by resident fish on juvenile salmonids in a **mainstem** Columbia reservoir: Part III. Abundance and distribution of northern squawfish, walleye, and smallmouth bass. Pages 211-248 in T. P. Poe and B. E. Rieman, editors. Predation by resident fish on juvenile salmonids in John Day Reservoir, Volume I -- Final report of research. (Contracts **DE-AI79-82BP34796** and **DE-AI79-82BP35097**) Bonneville Power Administration, Portland, Oregon.
- Mathews S. B. and T. K. Iverson. 1990. Evaluation of harvest technology for potential squawfish commercial fisheries in Columbia River reservoirs. In: Nigro, A. A., editor. 1990. Development of a system-wide predator control program: **Stepwise** implementation of a predation index predator control fisheries and evaluation plan in the Columbia River basin. Oregon Department of Fish and Wildlife (Contract **DE-B179-90BP07084**). 1990 Annual Report to Bonneville Power Administration, Portland Oregon.
- Mathews, S. B., T. K. Iverson, R. W. Tyler, and G. Ruggerone. 1989. Evaluation of harvesting technology for potential northern squawfish commercial fisheries in Columbia River reservoirs. In: Nigro, A. A., editor. 1989. Developing a predation index' and evaluating ways to **reduce salmonid** losses to predation in the Columbia River basin. Oregon Department of Fish and Wildlife (Contract **DE-AI79-88BP92122**). 1989 Annual Report to Bonneville Power Administration, Portland Oregon.
- North, J. A., R. C. Beamesderfer, T. A. Rien. 1992. Distribution and movements of white sturgeon in three lower Columbia River reservoirs. In review.
- Raymond, H. L. 1988. Effect of hydroelectric development and fisheries enhancement on spring and summer chinook salmon and steelhead in the Columbia River basin. North American Journal of Fisheries Management 8: 1-24
- Rieman, B. E., and R. C. Beamesderfer. 1990. Dynamics of a northern squawfish population and the potential to reduce predation on juvenile salmonids in a Columbia River reservoir. North American Journal of Fisheries Management 10:228-241
- Rieman, B. E., R. C. Beamesderfer, S. Vigg, and T. P. Poe. 1988. Predation by resident fish on juvenile salmonids in a **mainstem** Columbia reservoir: Part IV. Estimated total loss and mortality of juvenile salmonids to northern squawfish, walleye, and smallmouth bass. Pages 249-273 in T. P. Poe and B. E. Rieman, editors. Predation by resident fish on juvenile salmonids in John Day Reservoir, Volume I -- Final report of research. (Contracts **DE-AI79-82BP34796** and **DE-AI79-82BP35097**) Bonneville Power Administration, Portland, Oregon.

Vigg, S., C.C. Burley, D.L. Ward, C. Mallette, S.S. Smith, and M.P. Zimmerman. 1990. Development of a system-wide predator control program: **Stepwise** implementation of a predation index, predator control fisheries, and evaluation plan in the Columbia River basin. In: Nigro, A.A., editor. 1990. Development of a system-wide predator control program: **Stepwise** implementation of a predation index predator control fisheries and evaluation plan in the Columbia River basin. Oregon Department of Fish and Wildlife (Contract **DE-B179-90BP07084**). 1990 Annual Report to Bonneville Power Administration, Portland Oregon.

## APPENDIX

Fig.C-1. Locations of Registration Sites on the Lower Columbia River

Fig. C-2. Registration Form

Fig. C-3. Voucher Form

Fig. C-4. Log Book Form

Fig. C-5. Biological Data Form

Fig. C-6. Observation Form

# WASHINGTON

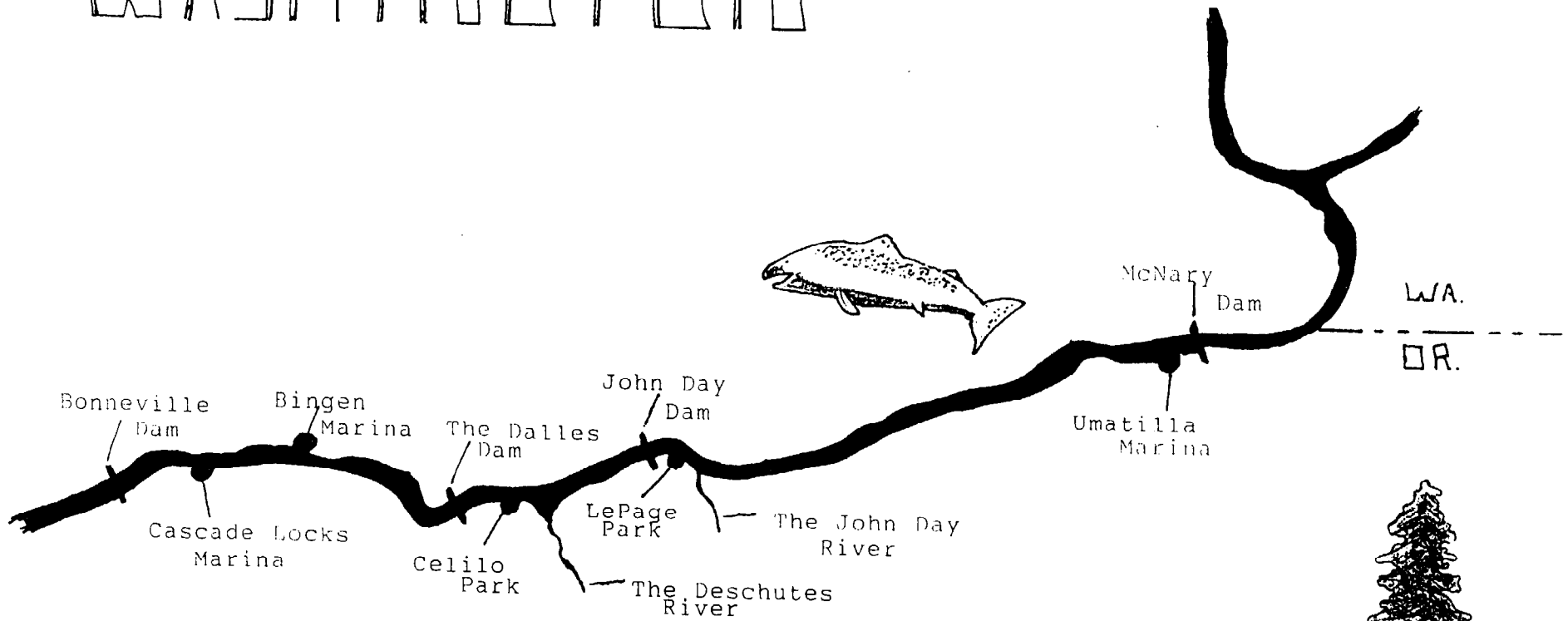

34

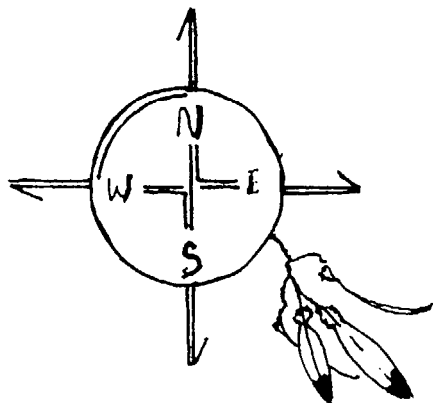

# OREGON

Fig. C-1. Locations of Tribal Longline check stations on The Lower Columbia River during the 1991 field season.

# NSQF TRIBAL LONGLINE REGISTRATION FORM

Fisherman's Name:			Registration Site:		
Fisherman's Registration No. :		Gen. Fishing Location:			
Crew members:			<b>CATCH REGISTRATION AND EXIT INTERVIEW</b>		
REGISTRATION TO: SET LONG-LINES			PULL LONG-LINES		
Date (YY/MM/DD)			How much time spent on shore for preparing gear and bait?[hr.min.]		
Start Time (Milli)			Total time on water?[hr.min.]		
No. of Longlines			Did you use a depth finder?		
No. of Hooks			Is your log book complete?		
ODFW Clerk No.			Logbook-formNo.s:		
Item:	Amount:	Description:	Cost [\$]:	Was ODFW observer on board?	
Fuel	gal			Did you set the gear again?	
Oil	pts			Do you have any comments?	
Ice	lbs				
Bait	lbs				
Misc. supplies				Total No. of NSQF brought in:	
Food				No. of NSQF > 11':	
Gear maintenance				Voucher No.:	
Engine maintenance				ODFW Clerk No.:	
Other (specify)					

Clerk's comments:

Fig. C-2. Registration Form

OREGON DEPT. OF FISH AND WILDLIFE  
PACIFIC STATES MARINE FISHERIES COMMISSION  
1991 NSQF TRIBAL LONGLINE VOUCHER

Date : \_\_\_\_\_

Fisherman's Name: \_\_\_\_\_  
Last First Middle

Fisherman's ID No.: \_\_\_\_\_

No. of NSQF: \_\_\_\_\_ Amount \$ \_\_\_\_\_

\_\_\_\_\_  
Fisherman

\_\_\_\_\_  
ODFW Clerk

Fig. C-3. Voucher Form

Fisherman's Name:					Long-line n o . . :				
Fisherman's ID no. :			Location:						
Distance to nearest shore point [yards]:									
Line length [feet]:							No. of hooks:		
Line depth [feet] min - max:							Bait type:		
		Line set			Line pulled			<b>ODFW Verification</b> Location ID: Comments: Clerk No.:	
Date (YY/MM/DD)									
Gear work start		am	pm	am	pm				
Gear work stop		am	pm	am	pm				
Species		# caught	# lost	# kept	# released and condition was				
		good	poor	dead					
Squawfish	1								
Sturgeon	2								
Catfish	3								
Bass	4								
Walleye	5								
Salmon/Steelhead	6								
Other (specify)	7								

Fisherman's Comments:

Fig. C-4. Log Book Form



# 1991 NSQF TRIBAL LONGLINE BIO DATA FORM

Date (YY/MM/DD) :

Registration Form No.:

Page \_\_\_ of \_\_\_

ODFW Clerk No.: \_\_\_\_\_

Fork No.	Length (mm)	Weight (g)	Disp.	Scale	Sex	Mat.	Tag No.	Color	Mark	Gon. Samp.	Gonad Weight (g)	Comments
1												
2												
3												
4												
5												
6												
7												
8												
9												
0												
1												
2												
3												
4												
5												
6												
7												
8												
9												
0												
1												
2												
3												
4												
5												

Fig. C-5. Biological data Form

# NSQF TRIBAL LONGLINE OBSERVATION FORM

Page - of -

Fisherman's Name				Date (YY/MM/DD)																																																																																																												
Fisherman's ID No.				Weekday		Weekend/Holiday																																																																																																										
Launch Site				Start Time (military)																																																																																																												
Fishing Location				ID #				Stop Time (military)																																																																																																								
Distance to nearest shore point (yds)						Time on Water (min)																																																																																																										
Weather		Wind		River		Comments																																																																																																										
<input type="checkbox"/> sun		<input type="checkbox"/> NW <input type="checkbox"/> SW		<input type="checkbox"/> smooth																																																																																																												
<input type="checkbox"/> overcast		<input type="checkbox"/> N <input type="checkbox"/> S		Cl swells < 2'																																																																																																												
<input type="checkbox"/> rain		ONE <input type="checkbox"/> SE		<input type="checkbox"/> swells > 2'																																																																																																												
<input type="checkbox"/> fog		Temp. (F)		Turb. (cm)																																																																																																												
Describe how fishing gear was deployed																																																																																																																
How many hooks were empty?				<30%		<50%		>50%																																																																																																								
<b>INCIDENTAL CATCH</b>																																																																																																																
<table border="1" style="width: 100%; border-collapse: collapse;"> <thead> <tr> <th rowspan="2">Fish No.</th> <th rowspan="2">Species</th> <th rowspan="2">Fork Lgth (mm)</th> <th rowspan="2">Disp</th> <th rowspan="2">Tag No.</th> <th rowspan="2">5</th> <th rowspan="2">5</th> <th rowspan="2">MARK</th> <th rowspan="2">Comments</th> </tr> <tr> <th>5</th> <th>5</th> </tr> </thead> <tbody> <tr><td>1</td><td></td><td></td><td></td><td></td><td></td><td></td><td></td><td></td></tr> <tr><td>2</td><td></td><td></td><td></td><td></td><td></td><td></td><td></td><td></td></tr> <tr><td>3</td><td></td><td></td><td></td><td></td><td></td><td></td><td></td><td></td></tr> <tr><td>4</td><td></td><td></td><td></td><td></td><td></td><td></td><td></td><td></td></tr> <tr><td>5</td><td></td><td></td><td></td><td></td><td></td><td></td><td></td><td></td></tr> <tr><td>6</td><td></td><td></td><td></td><td></td><td></td><td></td><td></td><td></td></tr> <tr><td>7</td><td></td><td></td><td></td><td></td><td></td><td></td><td></td><td></td></tr> <tr><td>8</td><td></td><td></td><td></td><td></td><td></td><td></td><td></td><td></td></tr> <tr><td>9</td><td></td><td></td><td></td><td></td><td></td><td></td><td></td><td></td></tr> <tr><td>0</td><td></td><td></td><td></td><td></td><td></td><td></td><td></td><td></td></tr> </tbody> </table>												Fish No.	Species	Fork Lgth (mm)	Disp	Tag No.	5	5	MARK	Comments	5	5	1									2									3									4									5									6									7									8									9									0								
Fish No.	Species	Fork Lgth (mm)	Disp	Tag No.	5	5	MARK	Comments																																																																																																								
									5	5																																																																																																						
1																																																																																																																
2																																																																																																																
3																																																																																																																
4																																																																																																																
5																																																																																																																
6																																																																																																																
7																																																																																																																
8																																																																																																																
9																																																																																																																
0																																																																																																																
Observer's Comments																																																																																																																

Fig. C-6. Observation Form



REPORT B.

Evaluation of the Northern Squawfish Sport-Reward Fishery  
in the Columbia And Snake Rivers

Prepared by

Craig C. Burley, Daniel C. Klaybor,  
Greg W. Short, and Gregory J. Hueckel  
Washington Department of Wildlife

**July 31, 1992**



## CONTENTS

	<u>Page</u>
ACKNOWLEDGMENTS .....	45
ABSTRACT .....	46
INTRODUCTION .....	47
METHODS .....	47
Study Area .....	47
Field Procedures .....	48
Registration	
Exit Interview	
Feasibility of a Creel Survey For Assessing	
<b>Impacts</b> by the Sport-Reward Fishery on Game,	
Food, and Unclassified Fishes	
Data Verification and Quality Control .....	52
Data Analysis .....	52
Sport-Reward Fishery	
Game Fish Survey	
RESULTS .....	53
Northern Squawfish Catch Data .....	53
Game, Food, and Unclassified Fish Species Data .....	64
Game Fish Survey Feasibility .....	64
DISCUSSION .....	72
Sport-Reward Fishery .....	72
Game Fish Survey Feasibility .....	72
Recommendations for <b>1992</b> Sport-Reward Fishing Season .....	75
SUMMARY .....	76
REFERENCES .....	77
APPENDIX A. Check station location codes .....	81
APPENDIX B. Examples of data forms used during the <b>sport-</b> reward fishery, and a list of the registration, exit, and biological data codes .....	83
APPENDIX C. Maps showing the fishing locations and codes for the <b>1991</b> northern squawfish sport-reward fishery .....	95
APPENDIX D. An example of the angler fish data base form used during the creel survey during May 24-September <b>22, 1991</b> .....	107



## ACKNOWLEDGMENTS

This project was funded by Bonneville Power Administration, William Maslen, Project Manager (Contract DE-B179-90BP07084). We thank Chuck Willis, David Ward and his staff, Christine Mallette and her staff, Oregon Department of Fish and Wildlife; Susan Hanna and her staff, Oregon State University; Stephen B. Mathews and his staff, University of Washington; Lewis J. (Sam) Bledsoe, Computer Sciences Corporation; Roy Beaty and his staff, Columbia River Inter-Tribal Fish Commission; Bruce H. Monk and Earl Dawley, National Marine Fisheries Service; and Pam Kahut and her staff, Pacific States Marine Fisheries Commission for their cooperation and coordination.

We thank the U. S. Army Corps of Engineers for the use of their project facilities at Hamilton Island Boat Ramp, LePage Park, Plymouth Boat Ramp, Hood Park, Windust Park, and the Greenbelt Boat Ramp. We thank the Washington State Parks and Recreation Commission for the use of their facilities at Maryhill State Park, Central Ferry State Park, and Chief Timothy State Park. We thank the Port of Cascade Locks, the City of Bingen, The City of The Dalles, and the City of Richland for the use of their facilities. We thank Sheilla Cannon for coordinating the use of the facilities at The Fishery At Covert's Landing, and we thank Gene Turner for the use of the facilities at Lyons Ferry Marina.

We thank Robert Adamsen, Liane Anderson, Cynthia Atkins, Anthony Blaine, Montgomery Busselman, James Byrd, Marshall Crisp, Fara Currim, Stephen Davis, James Dewilde, Linda Dodte, Paul DuCommun, David Eadie, Stephen Eddy, Thomas Eidel, Scott Fielding, Eddie Ford, Jeri Fulbright, Margie Fyfield, Carol Galbreath, James Galbreath, Eric Gower, Barbra Griggs, Matt Gustafsen, Robert Haley, Daniel Hoffman, Kevin Hooker, Kurt Hubbard, John Johnson, Michael Keller, David Kiene, Tamara Kiene, Johnathan Kohr, Sean Larson, Larry Ledgerwood, Shawna Lomen, Susan Long, Eric Mattson, Ken McGee, Derrick Meaghers, Francis Menard, Robert Moore, Kathleen Moyer, Larry Nash, Terry Naval, Shaan Ovey, Karen Peterson, Robert Phelps, Robert Ramstad, Bill Rogers, Nickie Royse, Heidi Ruthardt, Thomas Quinn, David Schultz, Catherine Smith, Stephen Smith, Dennis Snyder, Joseph, Steele, Lynn Stewart, Bradley Taylor, Gregory Taylor, Christine Vinson, Eric Winther, Thomas Wood, and David Yates for their work conducting the sport-reward fishery check stations, and collecting the data necessary for the success of this program. We thank Laura Mann for her valuable assistance conducting the data verification and quality control.



## ABSTRACT

We are reporting on the progress of the northern squawfish *Ptychocheilus oregonensis* sport-reward fishery in the Columbia River Basin for the period of April 1-September 30, 1991. The objectives of this project are: to implement the Sport-Reward Fishery for northern squawfish at 15 creel check stations on the Washington and Oregon shores in the lower Columbia River and Snake River; to collect biological data on northern squawfish and other fish species caught and turned in to the check stations; to collect economic data from anglers participating in this fishery through a questionnaire; and to report on the in-season dynamics of the fishery.

We conducted the Northern Squawfish Sport-Reward Fishery from May 24-September 22, 1991. A total of 33,566 participants registered to fish for northern squawfish at the creel check stations. The average number of anglers per registration was 2.0. The returning anglers expended a total 24,186 angler days or 144,710 angler hours (6.0 hours per trip) to catch 159,162 northern squawfish 11 inches or longer.

A total of 62,140 (39%) northern squawfish had fork length measurements collected. The average fork length over the entire season and all locations combined was 344.8 mm (S.D.= 64.1). A total of 768 smallmouth bass, 453 channel catfish, and 185 walleye were turned into the check stations by participants. The average fork lengths of these species were 291.1 (n= 571, S.D.= 59.0), 416.3 (n= 220, S.D.= 83.1), and 543.0 (n=184, S.D.= 105.8) respectively. Peamouth had the highest catch of any unclassified fish species other than northern squawfish at 368. The average fork length was 262.1 (n= 308, S.D. = 42.6).

A feasibility study was conducted to develop a creel survey to estimate harvest of fish species other than northern squawfish. The incidental harvest of these species within the sport-reward fishery could then be quantified relative to the harvest outside the sport-reward fishery.

## INTRODUCTION

The Columbia Basin Fish and Wildlife Program (NPPC, 1987) has addressed the mortality of juvenile salmon and steelhead, during their downstream migration through the Columbia River system, as a major concern. Research on the in-reservoir losses of these juvenile salmonids is an area of work currently being funded by the Bonneville Power Administration (NPPC 1987, Section 206(b) (1) (A)). Predation by northern squawfish *Ptychocheilus oregonensis* is a major component of the mortality of juvenile salmonids in the John Day Reservoir (Poe and Rieman, editors 1988).

A system-wide predator control program on northern squawfish was developed in 1989 to implement a sustained exploitation rate of the northern squawfish population by 10-20% (Vigg and Burley 1989). A sustained harvest of 10-20% of the larger northern squawfish in the population (250 mm or longer) could restructure the population and reduce the impacts of predation on the juvenile salmonids outmigrating by as much as 50% (Rieman and Beamesderfer 1990).

A test fishery was implemented, by the Oregon Department of Fish and Wildlife (ODFW), in 1990 that incorporated three fishery types, a Tribal Longline Fishery in the John Day Reservoir, a Dam Angling Fishery at five federal dams (Bonneville, The Dalles, John Day, McNary, and Ice Harbor), and a Sport-Reward Fishery in the John Day Reservoir. All three fishery types were found to be successful and were scheduled to be implemented in multiple reservoirs during 1991 (Vigg et al. 1991). Due to this increased magnitude of the Northern Squawfish Predator Control Program several agencies were contacted to participate in the program. The Washington Department of Wildlife (WDW) was enlisted to conduct the Northern Squawfish Sport-Reward Fishery.

The objectives of this project were: to implement the Sport-Reward Fishery for northern squawfish at 15 check stations on the Washington and Oregon shores in the lower Columbia River and Snake River; to collect biological data on northern squawfish and other fish species caught and turned in to the check stations; to collect economic data from the angler through a questionnaire; and to report on the in-season dynamics of the fishery. The feasibility of assessing the impact of the Northern Squawfish Sport-Reward Fishery on game, food, and other unclassified fish species using a creel survey was conducted.

## METHODS

### Study Area

The Northern Squawfish Sport-Reward Fishery was conducted from Bonneville Tailrace to Priest Rapids Dam on the Columbia River and from the mouth to Hells Canyon Dam on the Snake River. Fifteen check stations were located on the lower Columbia and lower Snake Rivers (Figure 1). Specifically, the check stations on the Columbia River were located in Bonneville Tailrace -- Hamilton Island Boat Ramp, WA; The Fishery at Covert's Landing, OR; Bonneville Reservoir -- Cascade Locks Marina, OR; Bingen Marina, WA; The Dalles Boat Basin, OR; The Dalles Reservoir -- Maryhill State Park, WA; John Day Reservoir -- Lepage Park, OR; Plymouth Boat Ramp, WA; McNary Reservoir -- Columbia Point

Park, WA. On the lower Snake River in McNary Reservoir -- Hood Park, WA; Ice Harbor Reservoir -- Windust Park, WA; Lower Monumental Reservoir -- Lyons Ferry Marina, WA; Little Goose Reservoir -- Central Ferry State Park, WA; Lower Granite Reservoir -- Chief Timothy State Park, WA; Greenbelt Boat Ramp, WA.

The feasibility of assessing the impact of the Northern Squawfish Sport-Reward Fishery on game, food, and other unclassified fish species using a creel survey was conducted in the same areas as the sport-reward fishery.

#### Field Procedures

The sport-reward fishery for northern squawfish began Friday, May 24, and continued through Sunday, September 22, 1991. Hamilton Island Boat Ramp, The Fishery at Covert's Landing, Cascade Locks Marina, Bingen Marina, LePage Park, Plymouth Boat Ramp, Central Ferry State Park, Chief Timothy State Park, and Greenbelt Boat Ramp opened on May 24 1991. The Dalles Boat Basin, Maryhill State Park, Columbia Point Park, Hood Park, Windust, and Lyons Ferry Marina opened on July 15, 1991. Check station personnel consisted of one Scientific Technician II crew leader and two Scientific Technician I positions. A third Scientific Technician I was added to all sites on July 15th for the night shift Wednesday through Sunday. The check stations were open seven days per week from 6:00 a.m. to 9:00 p.m. with a daily closure between 12:00 p.m. and 3:00 p.m. Anglers were required to register daily prior to fishing and to use legal catch methods as spelled out in the regulations pamphlet for the state they fished in. Fish caught throughout the day were to be turned in to the check station site live or fresh on ice to receive payment.

#### Registration

At 5:00 a.m. WDW creel clerks reported to their respective field office (Appendix A) and performed the morning check list procedure for equipment needs. Registration/Exit equipment was set up and ready for the days activities by 6:00 a.m.

Data collected during the registration interview consisted of month, day, year, creel clerks initials, and check station location code. The anglers first name, middle initial and last name were recorded with telephone number, best contact time (day or night) and fishing license number. Anglers were not required to have a license to fish for northern squawfish in Washington, however, anglers fishing in Oregon waters were required to have a valid Oregon fishing license. The target species was recorded according to first, second, and third preference. Fishing type (boat or bank) was entered and the start time of the registration interview (Appendix B). The numbered document was then filed in an alphabetized file box by last name. The anglers were asked during registration to bring all species of fish kept, in addition to northern squawfish, back to the check station.

#### Exit Interview

Upon completion of fishing, anglers were required to return to the same check station they registered at. A WDW creel clerk used the anglers original registration document to conduct an exit interview (Appendix B). Data entered consisted of the clerks initials, stop time (time that participant came back

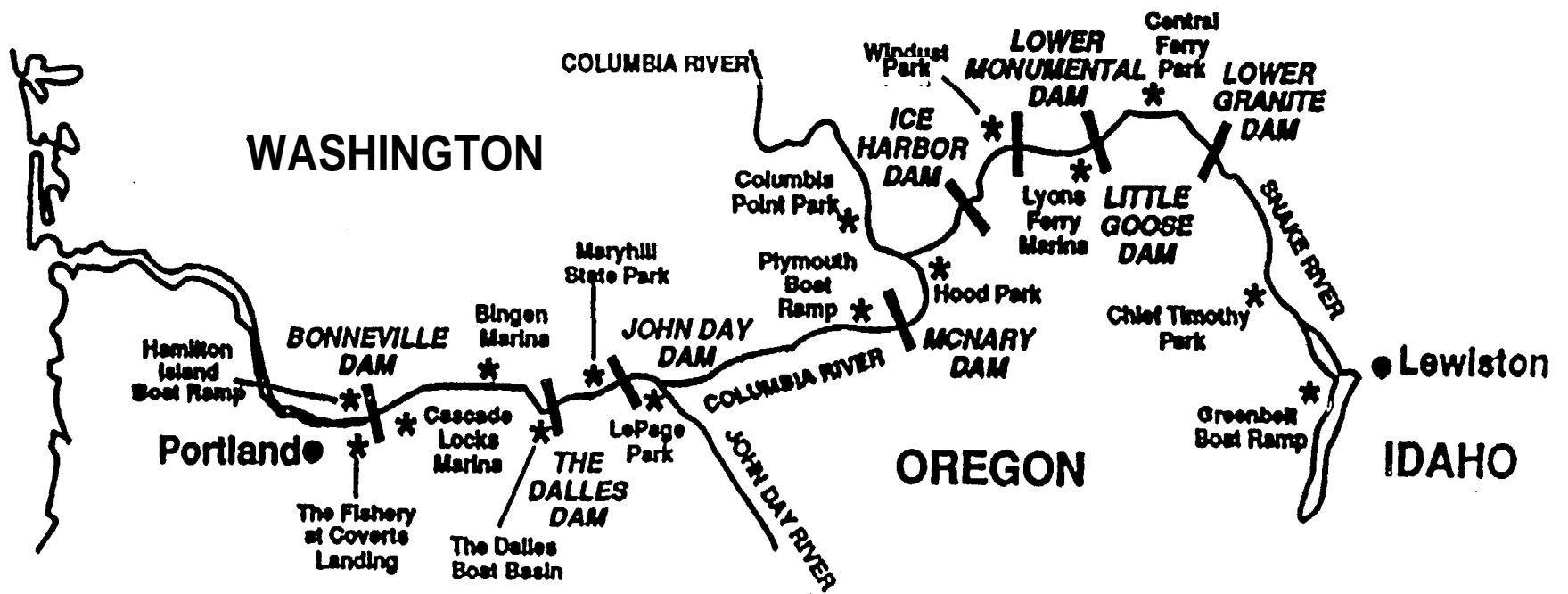

Figure 1. Location of the 15 northern squawfish sport-reward fishery check stations on the Columbia and Snake rivers during May 24-September 22, 1991.

to the site), actual hours fished, number of anglers in the party, and the location the angler fished (numbered map sections). The reservoirs were divided into approximately five mile sections and numbered consecutively (Appendix C). All fish turned in by anglers were inspected by creel clerks during the exit interview. Number of pay squawfish (number of squawfish 11 in. or longer eligible for \$3.00 reward per fish), number of northern squawfish turned in less than 11 in., and number of northern squawfish that were released or broke off were recorded. Northern squawfish qualifying for the reward were totaled and the angler was issued a pay voucher (Appendix B).

Information recorded on the voucher was angler name, address, city, state, and zip code. Also recorded were the month, day, and year, document number, social security number, number of reward northern squawfish, total reward (dollar amount) and voucher number. The creel clerk and the angler then signed the voucher. The angler was to complete the inside questionnaire at a later date which asked a series of questions used to evaluate the social and economic aspects of the sport reward program and then mail it to the ODFW for processing. The participant was issued a check within thirty days of receipt by the Pacific States Marine Fisheries Commission (sport reward dollars were funded by the Bonneville Power Administration).

Biological data were collected from a subsample of the fish brought to the check station sites. Data collected were creel clerk initials, weather code, total weight for squawfish 11 in. and longer, fish species, fork length ( $\pm 1$  mm), weight ( $\pm 1$  g), fish disposition, scale sample, tag number, tag color, secondary mark, and comments. Northern squawfish sex, maturity, gonad, and gonad weight ( $\pm 0.1$  g) were collected by ODFW technicians periodically at various check station sites. During periods when large numbers of fish were being turned in to a check station a subsampling regime was used.

Complete biological data were collected for northern squawfish catches numbering twenty or less. Those catches of greater than twenty fish were subsampled (fish species and fork length). Complete biological data was collected for every fourth fish (species, length, weight, scale sample, fish disposition, and sex). Northern squawfish returned to anglers after the exit interview were tail-clipped to indicate a voucher was issued for these fish. Other fish brought to the site (i.e., walleye, bass, catfish) were processed for biological data then returned to the angler. Northern squawfish turned in at the check stations were put on ice in coolers. If time allowed at the end of the shift, the clerks would subsample any fish not previously sampled for biological data.

At the end of the shift the northern squawfish were transferred to large commercial insulated totes and iced down for temporary storage. Oregon State University (OSU) picked up the northern squawfish at all field offices for various marketing tests (Hanna, 1992 this report).

Northern squawfish fishing derbies were held by various sponsors throughout the season in cooperation with WDW. The check station sites involved were notified in advance to prepare for the possible influx of participants. Cash prizes were rewarded for longest fish, most fish, etc. This was in addition to the three dollars per fish that the Bonneville Power Administration (BPA) was awarding. Some of the organizations donated the reward money to various charities.

## Feasibility of a Creel Survey For Assessing Impacts by the Sport-Reward Fishery on Game, Food, and Unclassified Fishes

A game fish survey was conducted from June 11-September 21, 1991 concurrent with the Northern Squawfish Sport-Reward Fishery. The survey area encompassed the impounded waters of the Columbia and Snake Rivers from approximately five miles below Bonneville Dam on the Columbia River to the upper end of Lower Granite Reservoir on the Snake River (Figure 1). This included the Bonneville Tailrace, Bonneville Reservoir, The Dalles Reservoir, John Day Reservoir, and McNary Reservoir on the Columbia River and Ice Harbor Reservoir, Lower Monumental Reservoir, Little Goose Reservoir, and Lower Granite Reservoir on the Snake River.

A stratified random sampling design was used to obtain independent estimates of game fish catch per unit effort (fish \* angler<sup>-1</sup> \* h<sup>-1</sup>) and fishing effort (angler \* h). These estimates were then expanded and used to calculate relative catch estimates by reservoir. Both interview and effort data were recorded using the Washington Department of Wildlife Angler Fish Database Information System (AFD Version 1.2, September 1991). Expanded catch estimates were obtained using the methodology in CREESYS: A Software System for Management of Ontario Creel Survey Data (Orsatti et al., 1986 unpublished manuscript).

Several constraints affected the design of the game fish survey. Two creel checkers were available, each for an average of two sample days per week. The study area was large, covering eight reservoirs (over 340 river miles). Effort counts were obtained from the ground at vantage points. It was therefore determined that a roving survey conducted on randomly selected sample days would most efficiently utilize the limited man-power and minimize sample bias.

Stratification by area was used to ensure representative catch per unit effort (CPUE) and effort count data. It was assumed that both effort and catch would vary widely throughout the reservoir due to access areas being clustered around dams and fishing pressure being heavier in tailrace areas versus remote mid-reservoir areas with limited access. Each reservoir was therefore stratified by area by dividing the reservoir into five subsections using area and access sites as criteria. When access was good throughout the reservoir, the subsections were selected to be roughly equal in area. This was the case in Columbia River Reservoirs where access was provided by freeways paralleling both sides of the river. Snake River reservoirs, however, had limited access and subsections were established around these access sites (parks, boat ramps, access roads, and dams). Individual subsections were numbered one through five starting from the forebay subsection and proceeding upstream to the tailrace subsection.

A weekday versus weekend strata was selected to minimize the variance between workdays and non-workdays (including holidays). The Angler Fish Database angler interview form (developed by WDW) we used also incorporated strata for complete versus incomplete trips, boat versus shore anglers, gear type, and target species (Appendix D).

Sample days were divided into interview days and effort count days. During interview days, anglers were interviewed to obtain CPUE. During effort count

days, counts of boat and shore anglers were conducted to approximate instantaneous effort counts. Angler counts for a subsection were usually completed in less than one hour.

Sample days for both interviews and effort counts were randomly selected at the beginning of the field season using a random number table. The 15 week survey period from June 11-September 21, 1991 consisted of 72 weekdays and 31 weekend days (including holidays). Based on approximately 2 man-days per week available during the 15 week survey period, 34 sample days were randomly selected (8 weekday count days, 8 weekend count days, 9 weekday interview days, and 9 weekend interview days). Weekday counts were therefore conducted on 11% of all possible weekdays. Weekend counts were conducted on 25% of all possible weekend and holiday days. Weekday creels were conducted on 12.5% of all possible weekdays. Weekend creels were conducted on 29% of all possible weekend and holiday days.

#### Data Verification and Quality Control

##### Sport-Reward Fishery

On Monday of each week, the crew leaders (Scientific Technician II positions) spent the day at the field office proofing the previous weeks data forms. The total number of northern squawfish turned in to each site and other fish species kept (i.e., walleye, bass, and catfish) were tallied for in-season reporting. On Wednesday of each week ODFW personnel picked up the registration documents and delivered them to ODFW data entry personnel. The ODFW entered the information on computer floppy discs and both original data sheets and keypunched data were sent to WDW. The WDW then downloaded the keypunched information in to their computer files.

As the data were received from ODFW (ASCII, text fixed length), the new data were compared to the existing data set and checked for duplicate entries prior to appending. The data were then appended to a data base file (Ashton Tate, dBASE IV version 1.1). After the new data were appended multiple queries were run to check for errors. The errors were cross checked with the original field data forms and the appropriate corrections made. A record of each correction that was made was kept on file for later verification if needed.

##### Game Fish Survey

The data that was collected in the field was brought back to the office and proofed for errors and missing data. The edited data forms were then entered into the Angler Fish Database Program (version 1.2, Washington Department of Wildlife September 1991).

#### Data Analysis

##### Sport-Reward Fishery

Computer programs were written in the Ashton Tate dBASE IV version 1.1 data base management program to retrieve subsets of the data for analysis. These data were analyzed to determine the catch and CPUE statistics by reservoir, and week, as well as changes in size composition of the catch by reservoir, and throughout the season.

## Game Fish Survey

The total effort counts (boat and bank anglers) were summed and averaged by reservoir section to yield mean effort (angler \* hours) per section. Mean effort by section was then multiplied by the number of fishing hours per day (12) to yield total effort by section per day. This result was then divided by the percent days sampled (sample day fraction); to yield total effort (angler \* hours) by section for the field season.

Relative catch (kept and released) estimates were calculated by reservoir for those species where at least 10 fish were caught. Relative catch estimates were calculated using pooled CPUE (fish caught per hour fished by all anglers) as opposed to targeted CPUE (targeted fish caught per targeted hours fished). Pooled CPUE was used because many anglers interviewed did not specify a target species. Target species codes of WW for warmwater game fish and ANY for any fish were recorded for these anglers. Pooled CPUE for each species was multiplied by angler effort to yield relative catch in each reservoir section. Relative catch by species was then standardized and expressed as percent of total catch.

## RESULTS

### Northern Squawfish Catch Data

A total of 33,566 participants registered to fish for northern squawfish at WDW check stations. The average number of anglers per registered participant was 2.0 anglers. Of those participants that registered 41.13% returned after their fishing trip. The returning anglers expended a total 24,186 angler days or 144,710 angler hours during May 24-September 22, 1991 to catch 159,162 northern squawfish 11 inches or longer. The check station at Covert's Landing and at LePage Park had the highest removals of northern squawfish of 40,674 and 32,141 respectively (Figure 2). The check station at Chief Timothy State Park had the lowest overall removal of 1,048 northern squawfish of any of the nine check stations that opened on May 24, 1991.

The Bonneville Tailrace had the largest removal of northern squawfish at 58,235 and Ice Harbor Reservoir the lowest removal at 919 northern squawfish (Figure 3). The majority of the northern squawfish caught were removed from the tailrace regions below the dams (Figures 4A-6C). In the Bonneville Reservoir, however, more fish were removed (6,061) from the forebay area (the area from the dam to approximately five miles above the dam) than any other location (Figure 4A).

The overall catch per unit effort (CPUE) was 1.09 fish \* angler<sup>-1</sup> \* h<sup>-1</sup>. The overall CPUE ranged from 0.50 fish \* angler<sup>-1</sup> \* h<sup>-1</sup> at the start of the fishery to 1.47 fish \* angler<sup>-1</sup> \* h<sup>-1</sup> during the week of July 1, to July 7, 1991 (Figure 7). The CPUE by reservoir ranged from 0.47 fish \* angler<sup>-1</sup> \* h<sup>-1</sup> in the John Day Reservoir, to 1.43 fish \* angler<sup>-1</sup> \* h<sup>-1</sup> in The Dalles Reservoir (Figure 8). An analysis of northern squawfish catch and CPUE by reservoir and by week (Figures 9A-11C) shows that Ice Harbor Reservoir had the highest CPUE of 3.33 fish \* angler<sup>-1</sup> \* h<sup>-1</sup> during the week of July 15-July 21, 1991.



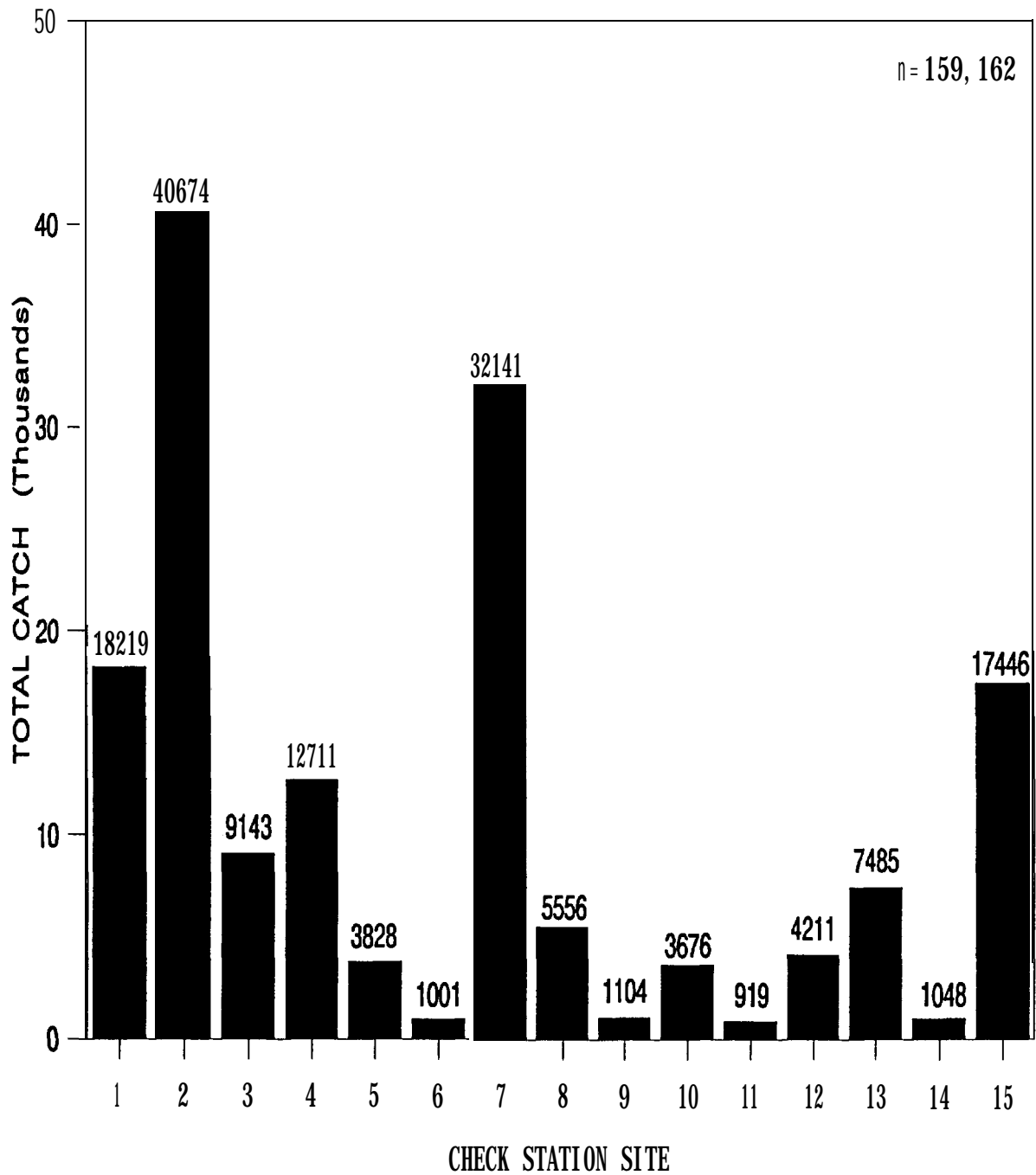

Figure 2. Catch of northern squawfish 11 inches or longer, by check station, during May 24-September 22, 1991; **1**= Hamilton Island Boat Ramp, **2**= Covert's Landing, **3**= Cascade Locks Marina, **4**= Bingen Marina, **5**= The Dalles Boat Basin, **6**= Maryhill State Park, **7**= LePage Park, **8**= Plymouth Boat Ramp, **9**= Columbia Point Park, **10**= Hood Park, **11**= Windust Park, **12**= Lyons Ferry Marina, **13**= Central Ferry State Park, **14**= Chief Timothy State Park, and **15**= Greenbelt Boat Ramp. Check stations **5, 6, 9, 10, 11,** and **12** opened July 15, 1991.

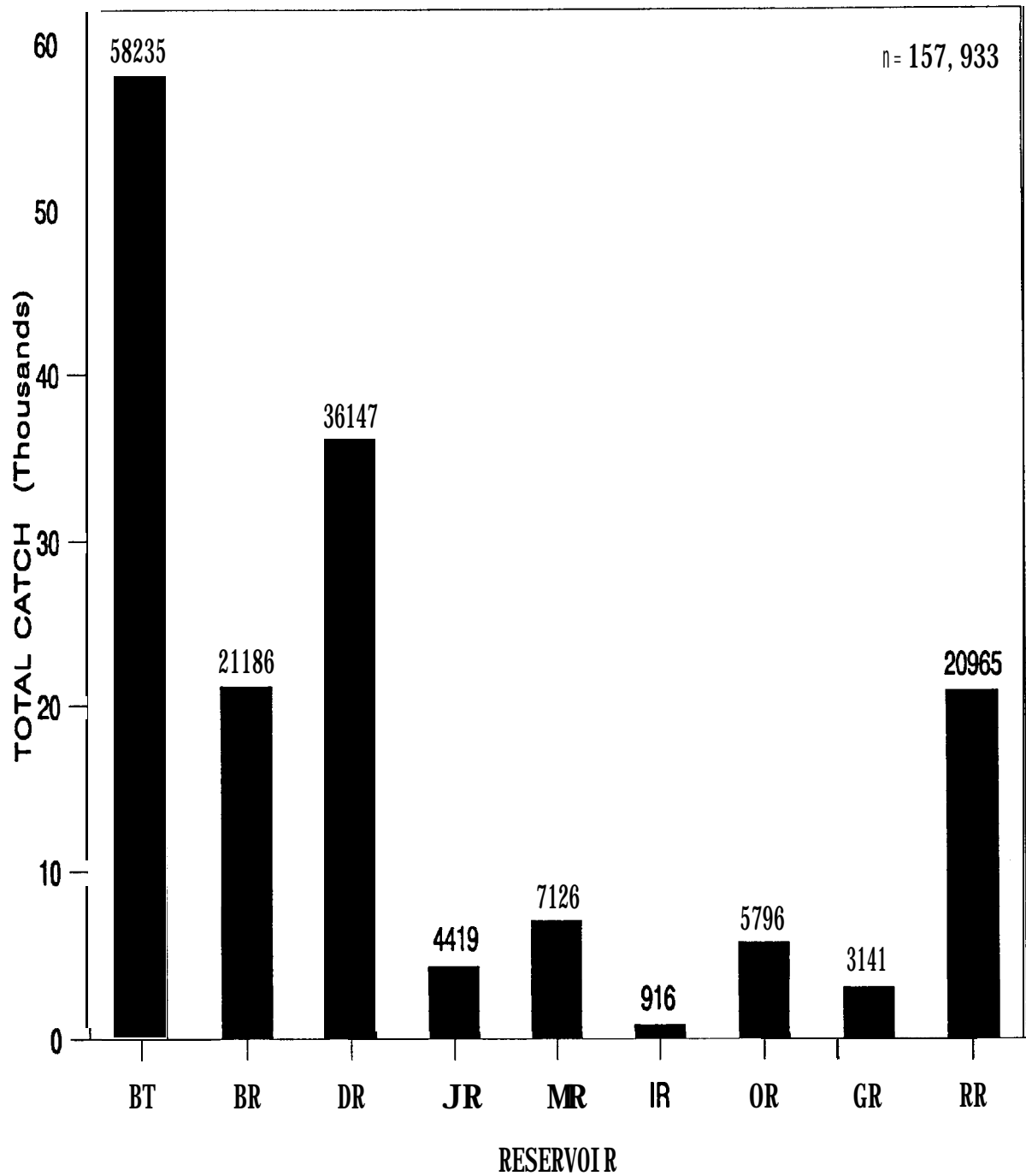

Figure 3. Catch of northern squawfish by reservoir (only fish with fishing location codes are shown); BT= Bonneville Tailrace, BR= Bonneville reservoir, JR= John Day Reservoir, MR= **McNary** Reservoir, IR= Ice Harbor Reservoir, OR= Lower Monumental Reservoir, GR= Little Goose Reservoir, RR= Lower Granite Reservoir.

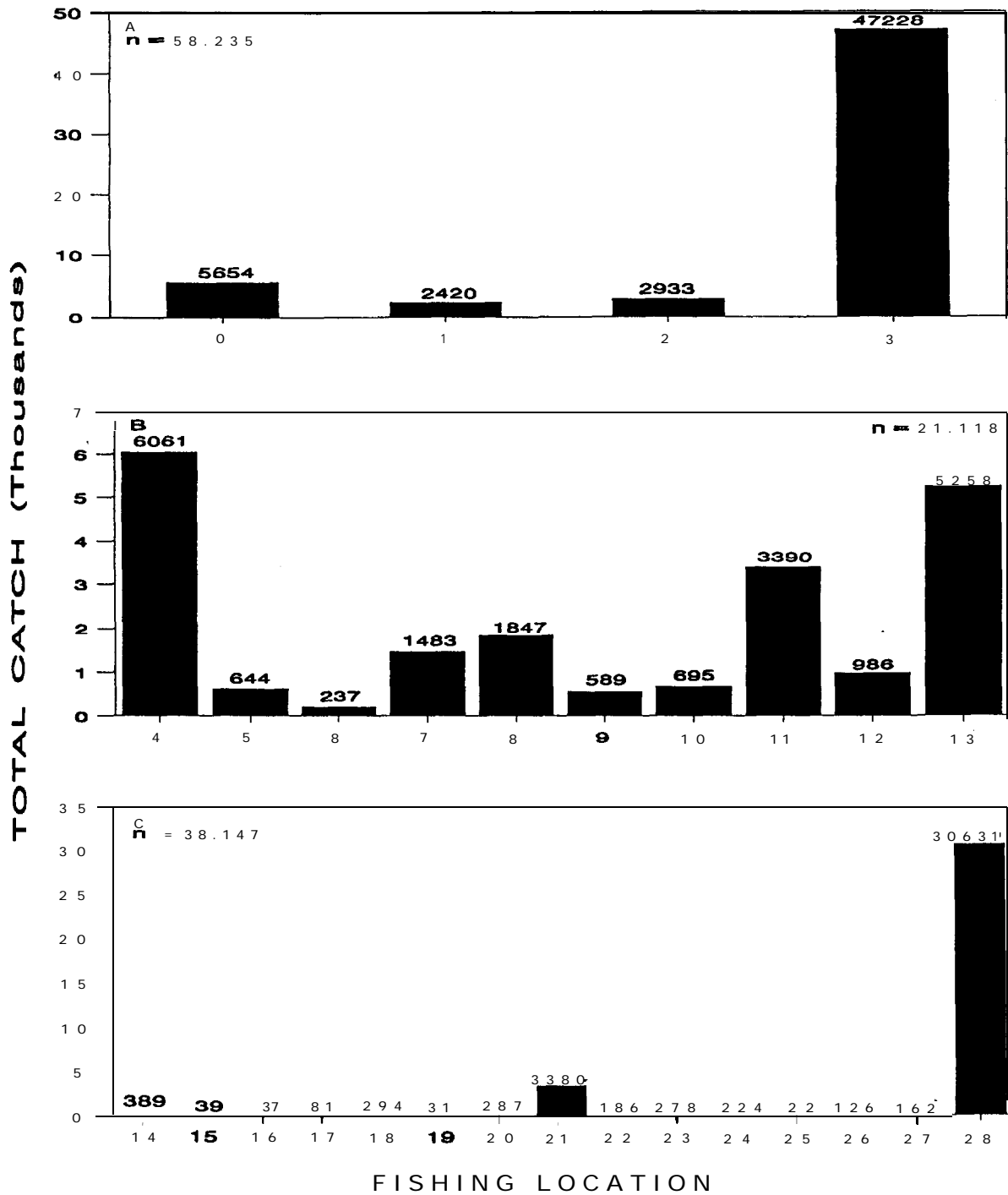

Figure 4. Catch of northern squawfish by fishing location, during May 24-September 22, 1991, in Bonneville Tailrace (A), Bonneville Res. (B), and The Dalles Res. (C); location codes progress upstream from left to right.

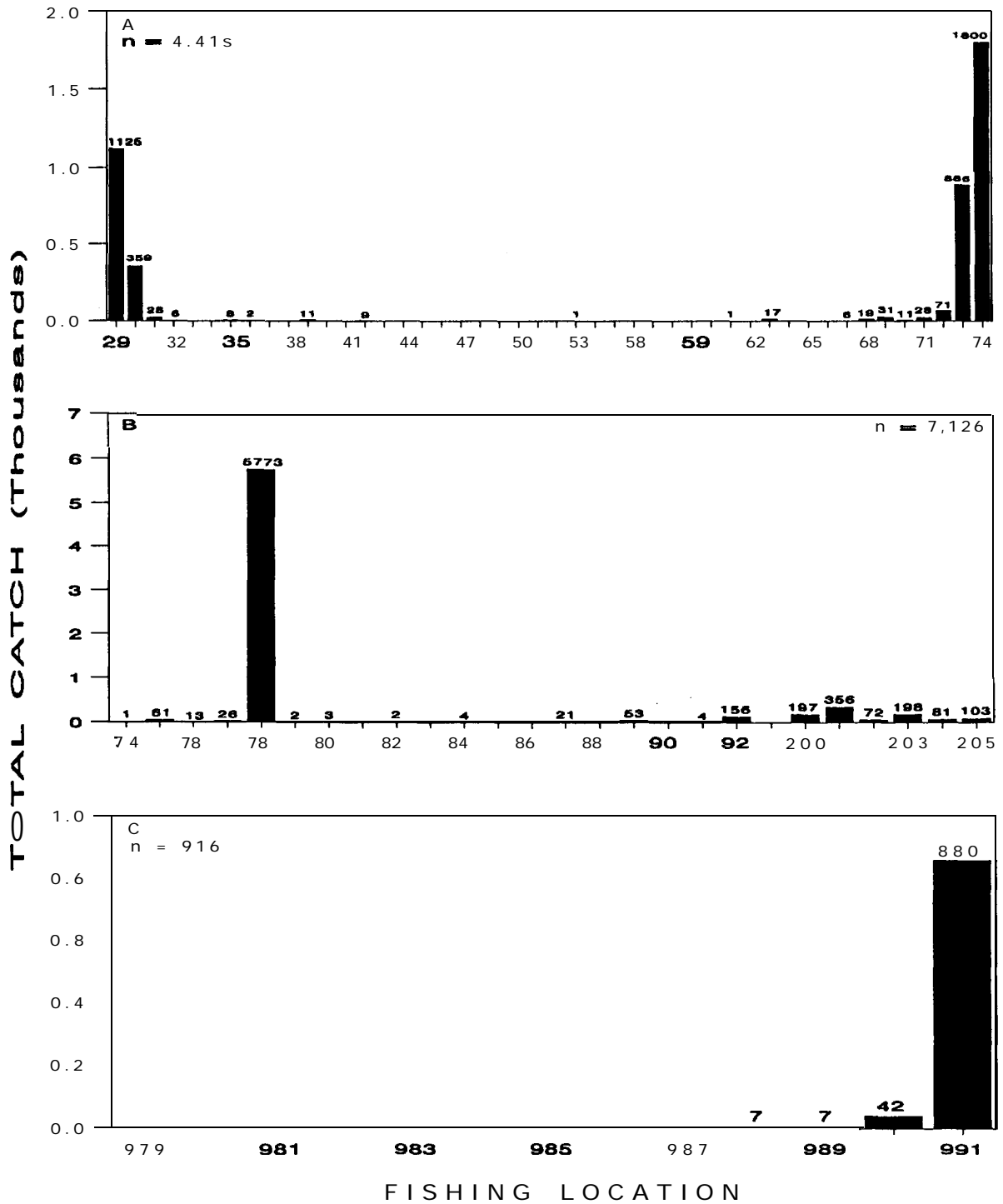

Figure 5. Catch of northern squawfish by fishing location, during May 24-September 22, 1991, in John Day Res. (A), McNary Res. (B), and Ice Harbor Res. (C); locations go upstream -- left to right.

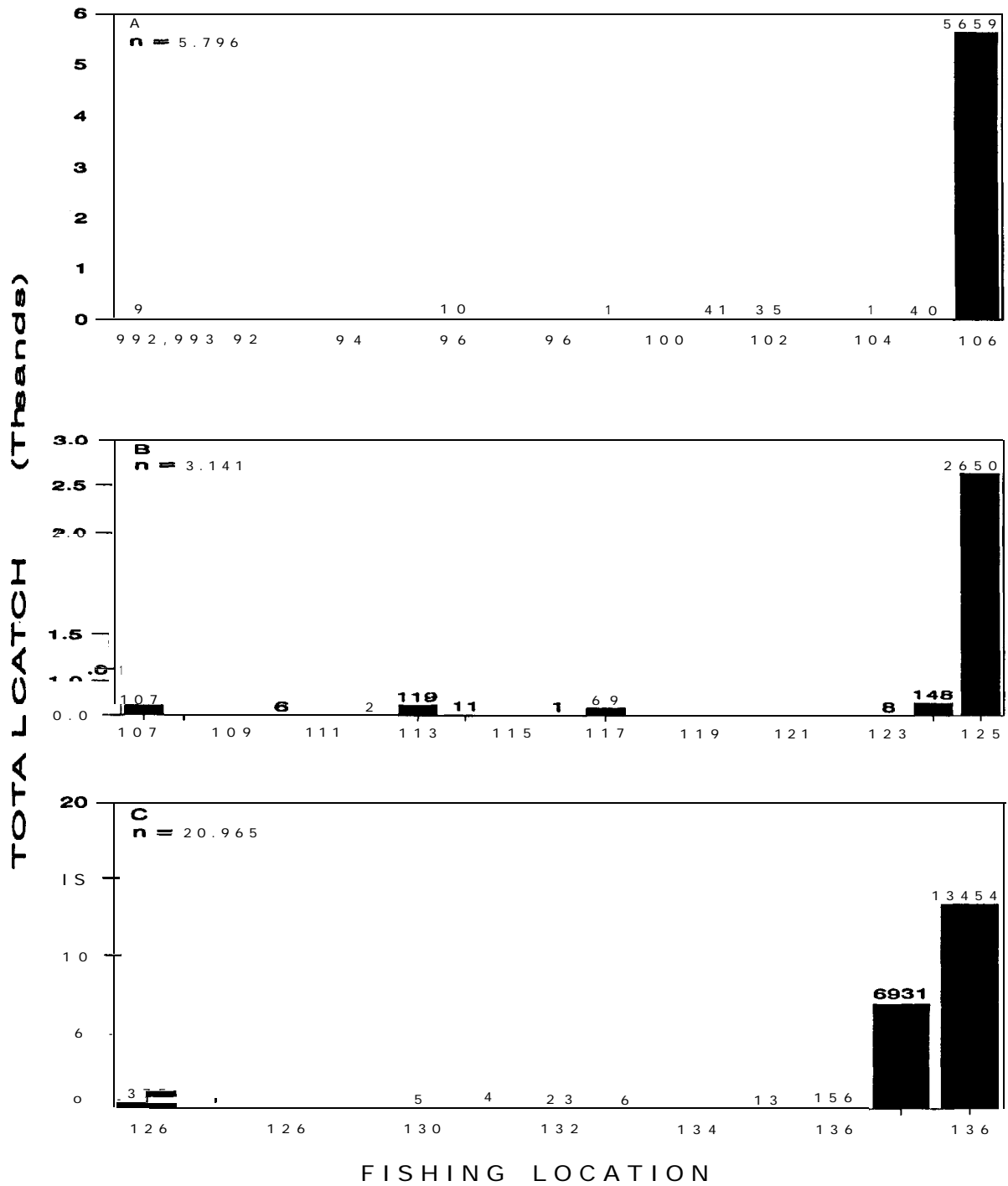

Figure 6. Catch of northern squawfish by fishing location, during May 24-September 22, 1991, in Lower Monumental Res. (A), Little Goose Res. (B), and Lower Granite Res. (C); location codes progress upstream from left to right.

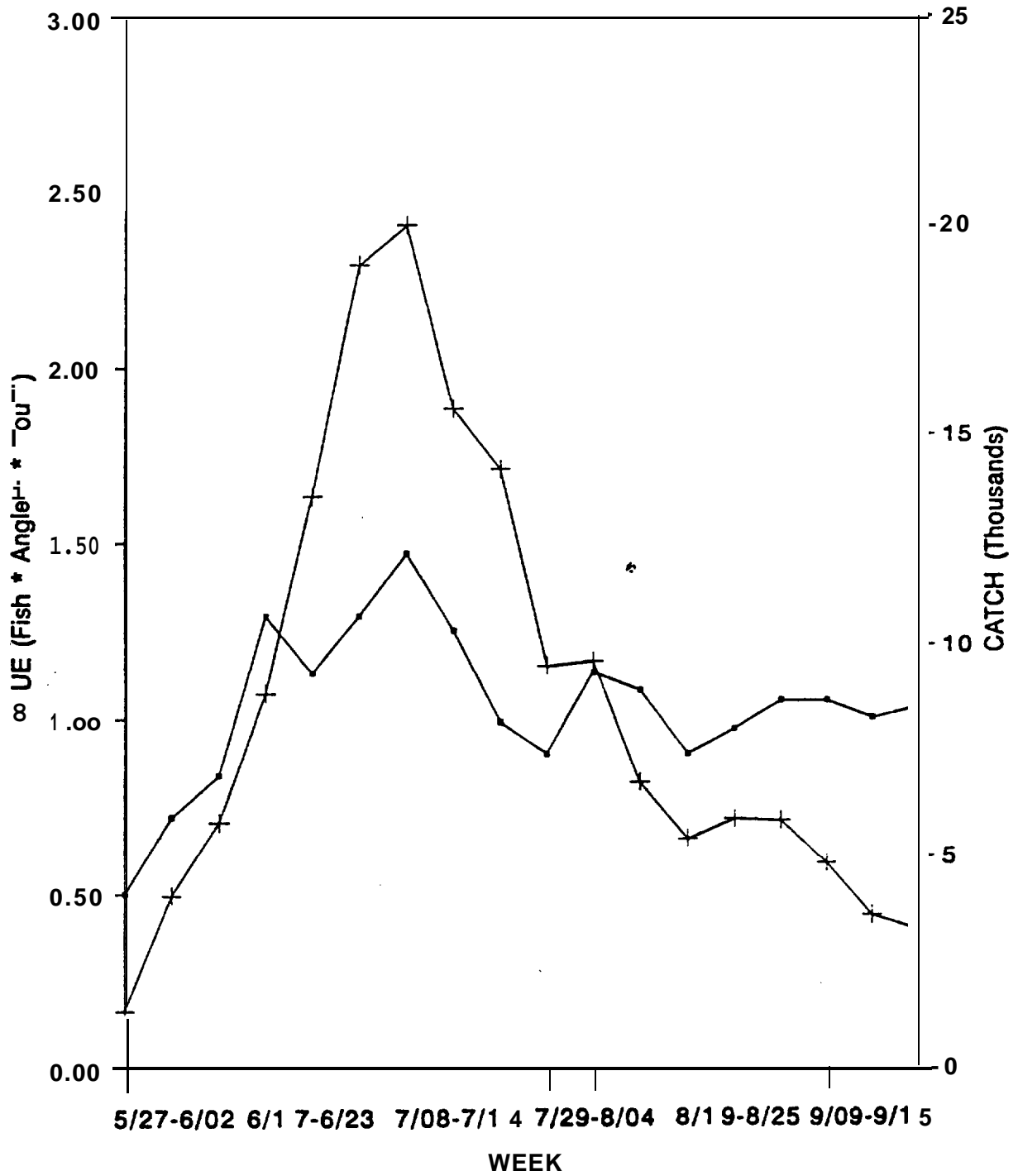

Figure 7. CPUE (■) and catch(+) by week during May 24-September 22, 1991 (CPUE for returning anglers).

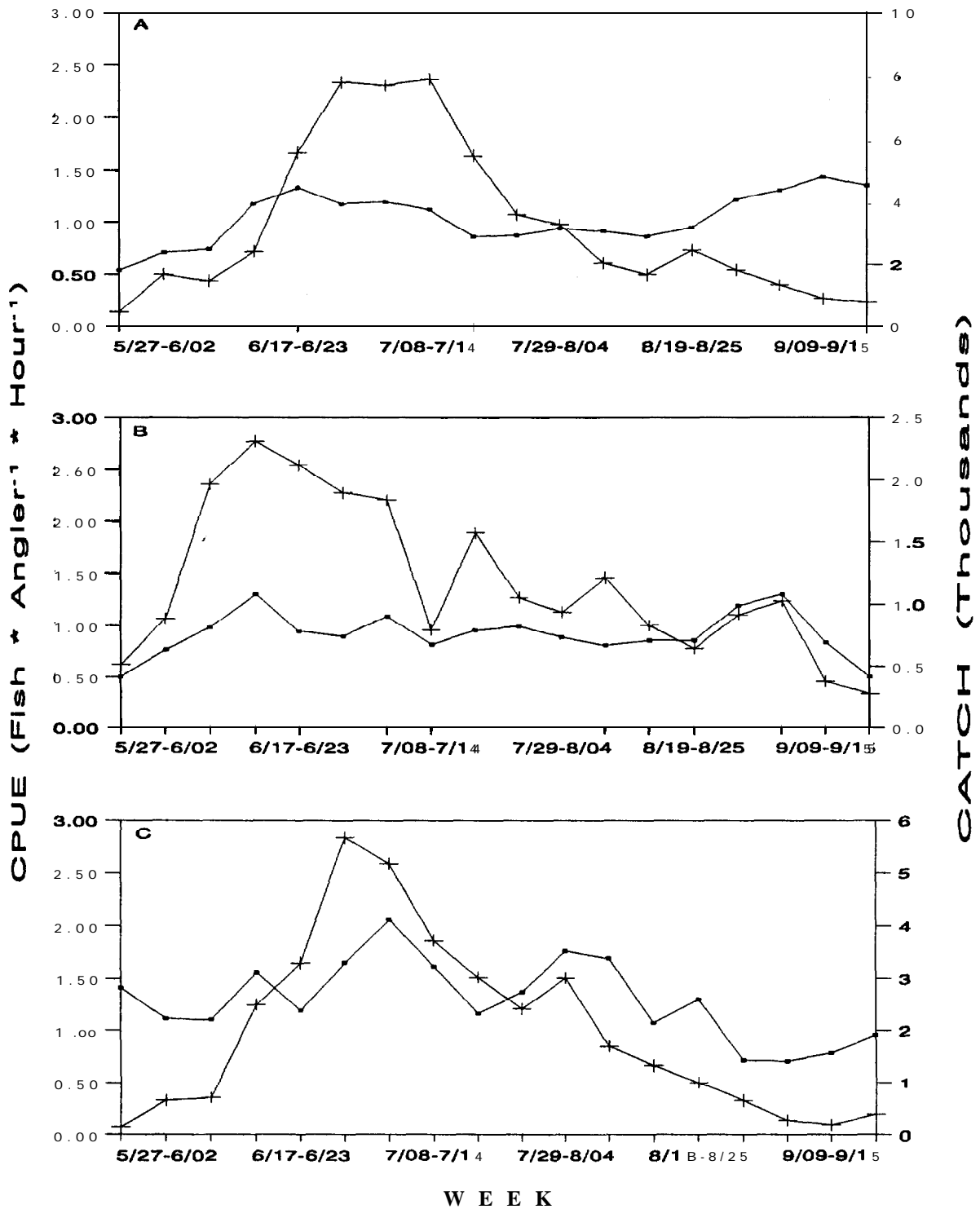

Figure 8. CPUE (■), and catch (+) by week for Bonneville Tailrace (A), Bonneville Res. (B), and The Dalles Res. (C), during May 24-September 22, 1991.

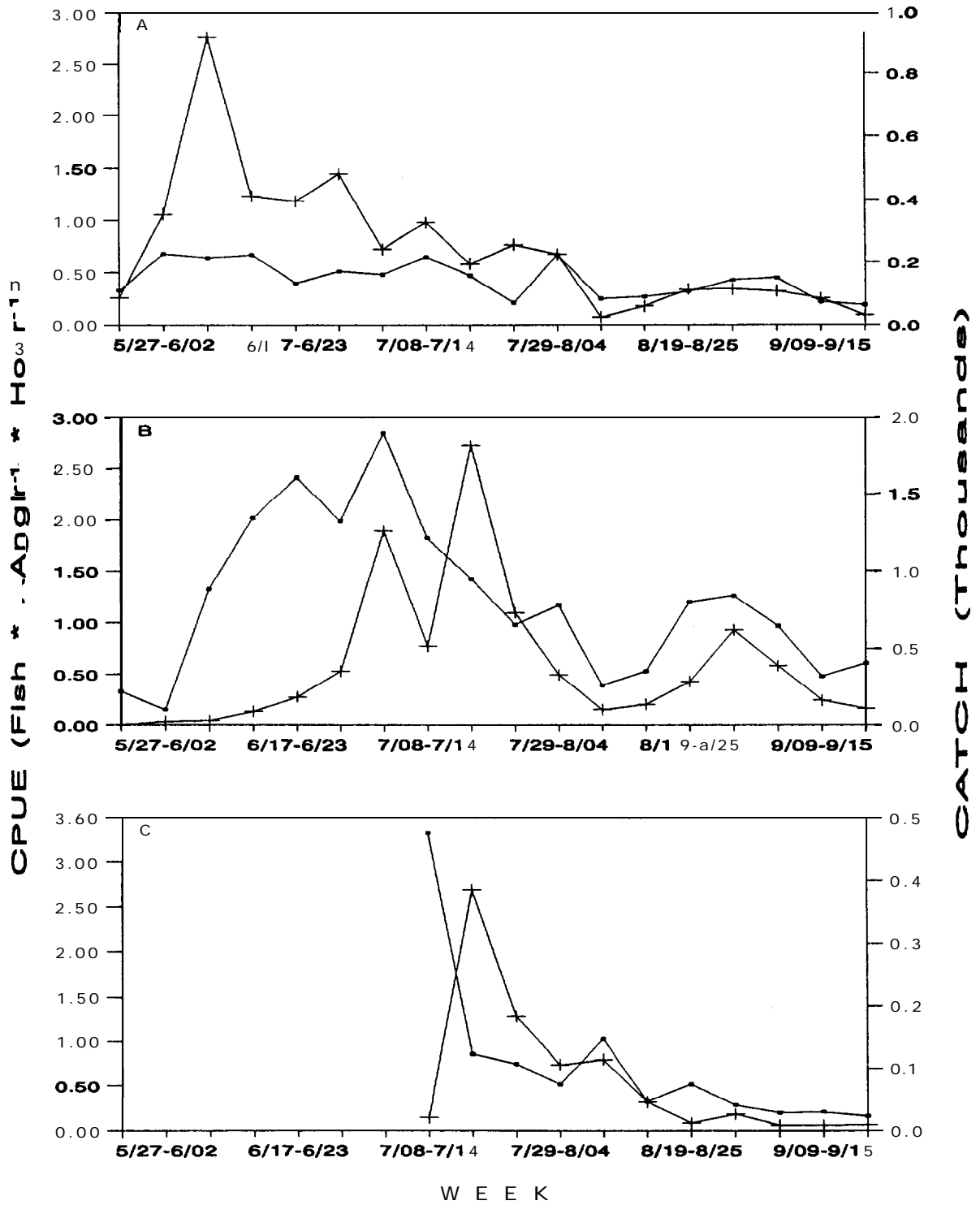

Figure 9. CPUE (■), and catch (+) by week for John Day Res. (A), McNary Res. (B), and Ice Harbor Res. (C), during May 24-September 22, 1991.



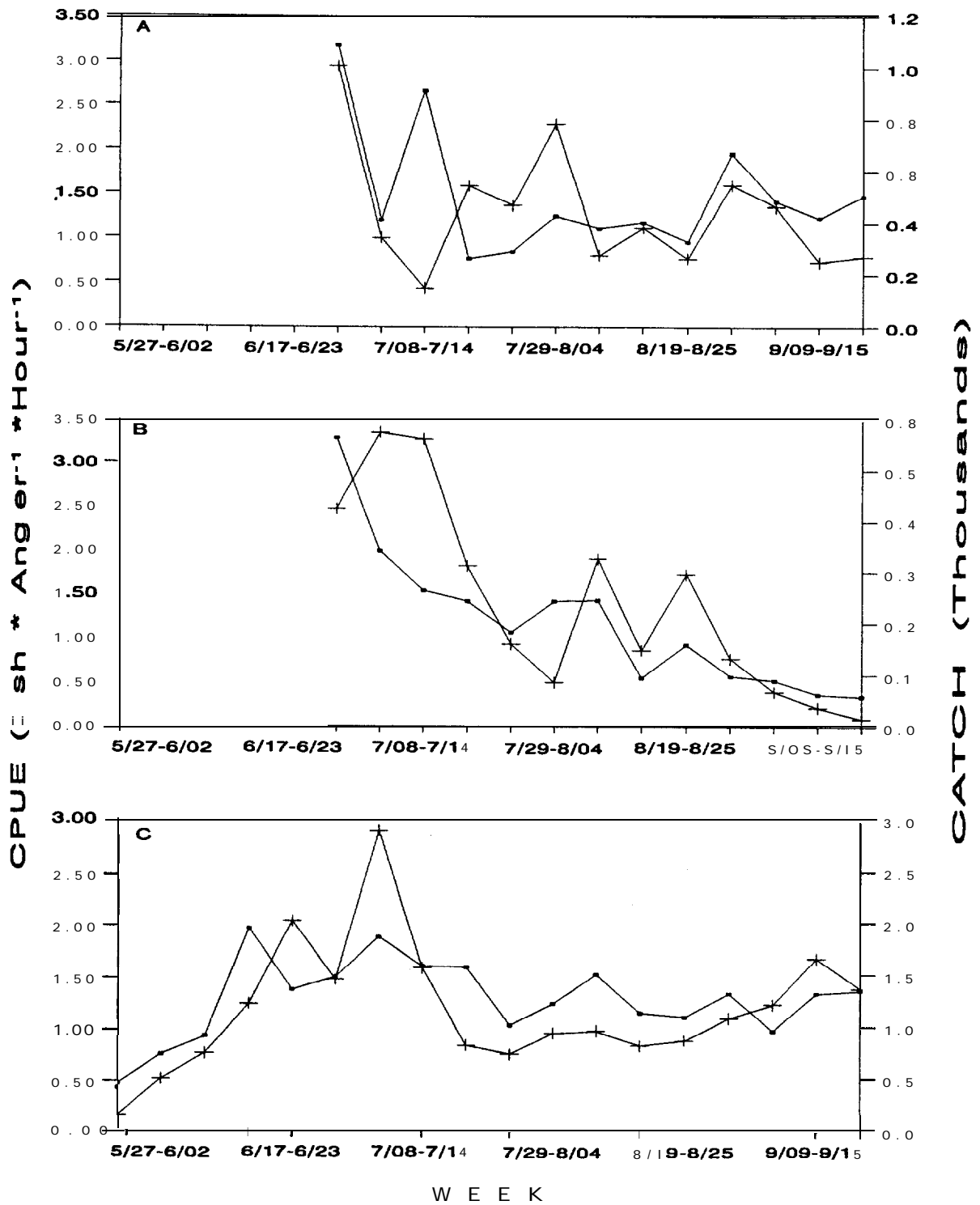

Figure 10. CPUE (■), and catch (+) by week for Lower Monumental Res. (A), Little Goose Res. (B), and Lower Granite Res. (C), during May 24-September 22, 1991.

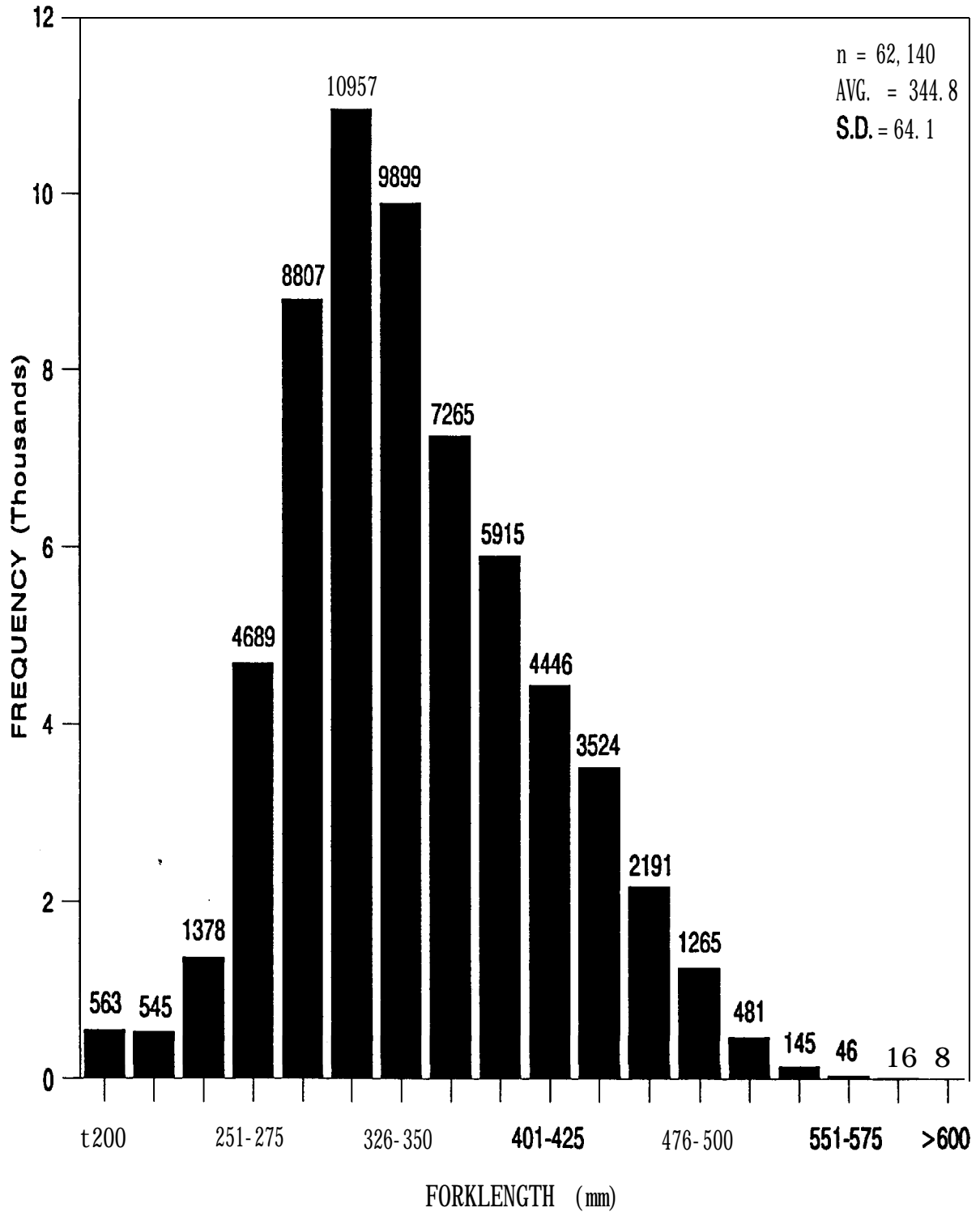

Figure 11. Length frequency distribution of northern squawfish caught in the sport-reward fishery at all locations, during May 24-September 22, 1991.

A total of 62,140 northern squawfish had fork length measurements taken during the season (Figure 12). The average length for all locations combined was 344.8 mm (S.D. = 64.0). We looked at the length frequency distribution by reservoir for the entire season. The means ranged from 316.1 mm (S.D. = 50.5) in the Lower Monumental Reservoir to 369.4 mm (S.D. = 58.8) in The Dalles Reservoir (Figure 13A-15C).

#### Game, Food, and Unclassified Fish Species Data

A total of 768 smallmouth bass (*Micropterus dolomieu*) were caught and turned into the check stations; more than any other species of fish excluding northern squawfish. A total of 453 channel catfish (*Ictalurus punctatus*) and 185 walleye (*Stizostedion vitreum*) were turned in to the check stations (Table 1). Smallmouth bass, channel catfish and walleye length frequencies were graphed (Figure 16A-16C). The mean lengths were, smallmouth bass 291.1 (n= 571 S.D.= 59.0), channel catfish 416.3 (n= 220 S.D.= 83.1) and walleye 543.0 (n= 148 S.D.= 106.0).

We looked at the other fish species caught in the Northern Squawfish Sport-Reward Fishery relative to if the angler was targeting on those fish species. We found that of the 768 smallmouth bass that were caught 40 percent of those were caught by anglers targeting on smallmouth bass while participating in the program (Figure 17). Seventy percent of the 10 summer steelhead caught in the program were targeted on. Peamouth, other than northern squawfish, had the largest number of any unclassified fish species caught (368). The peamouth were 100 percent incidental catch to the program. Individual fish specimens (192) that appear to be a cross between the northern squawfish and chiselmouth were turned into the check stations. Work continues to determine if these are hybridized fish or not. We have named these individuals Columbia river chub for the purposes of reporting in this report (Table 1.)

#### Game Fish Survey Feasibility

A total of 221 random effort counts were conducted during the 1991 field season. It should be noted that the creel clerk working on the Columbia River reservoirs conducted effort counts on angler interview days as well as the effort count days. Since these effort counts were also randomized by sample day and pool section and were generally completed within one hour, they were included in the effort count database. Effort counts were stratified by pool section and expanded to yield total effort per section for the field season (Table 2). Note that the number of effort counts by section is non-uniform due to random selection of pool sections on a given effort count sample day.

A total of 718 anglers were interviewed during the 1991 field season for a total catch (kept and released) of 1,188 fish. Overall catch (all species combined) per angler was much higher for Snake River reservoirs than for Columbia River reservoirs (Figure 18).

The catch composition over the entire season and all reservoirs shows smallmouth bass to be the most prevalent fish species in the catch at 477 fish (Figure 19A and 196). Relatively high numbers of game fish were released by anglers. Northern squawfish ranked behind smallmouth bass and channel catfish in total numbers caught (kept and released), but ranked approximately even with these two species when comparing total numbers kept.

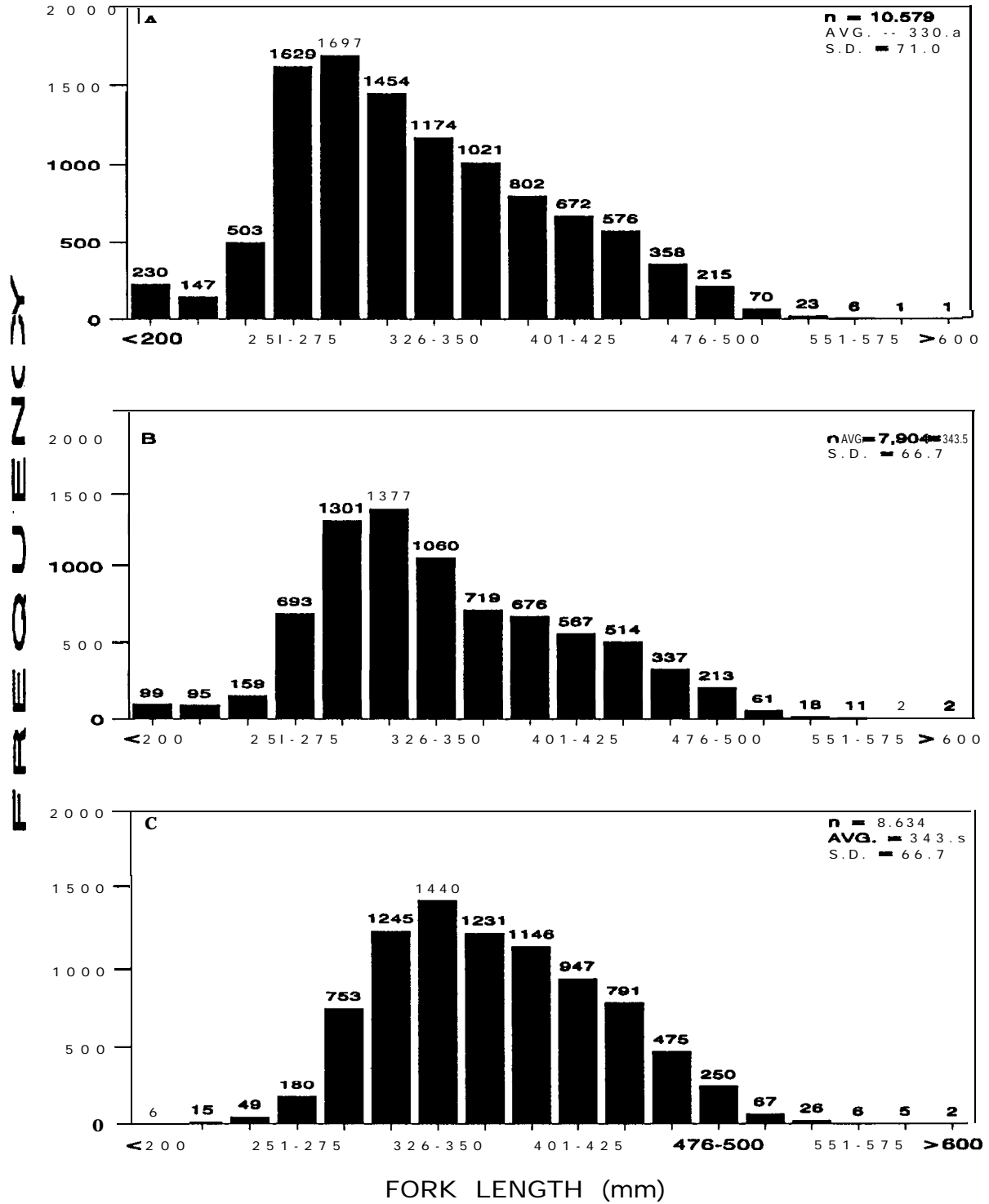

Figure 12. Length frequency distribution of northern squawfish by reservoir, during May 24-September 22, 1991; Bonneville Tailrace (A), Bonneville Res. (B), and The Dalles Res. (C).

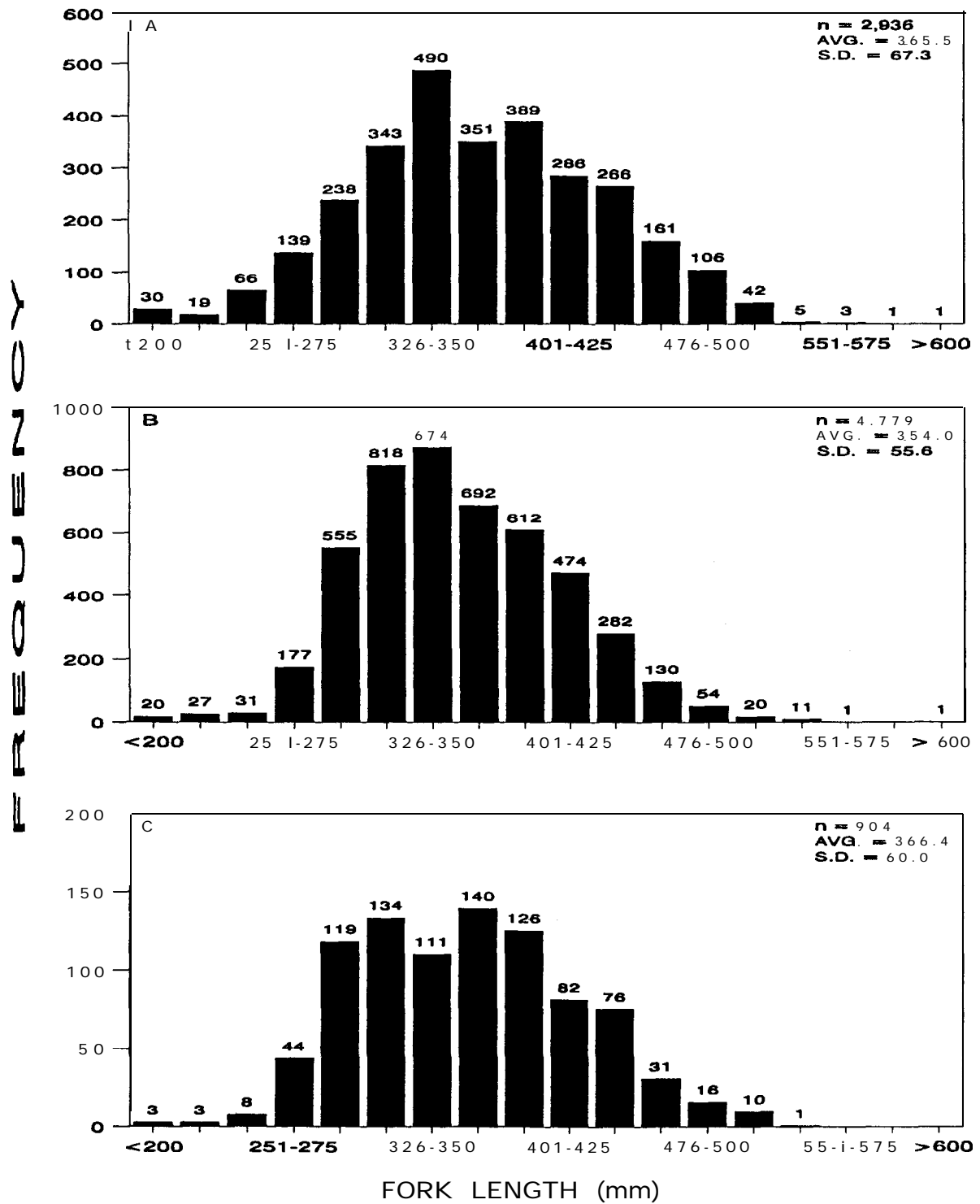

Figure 13. Length frequency distribution of northern squawfish by reservoir, during May 24-September 22, 1991; John Day Res. (A), McNary Res. (B), and Ice Harbor Res. (C).

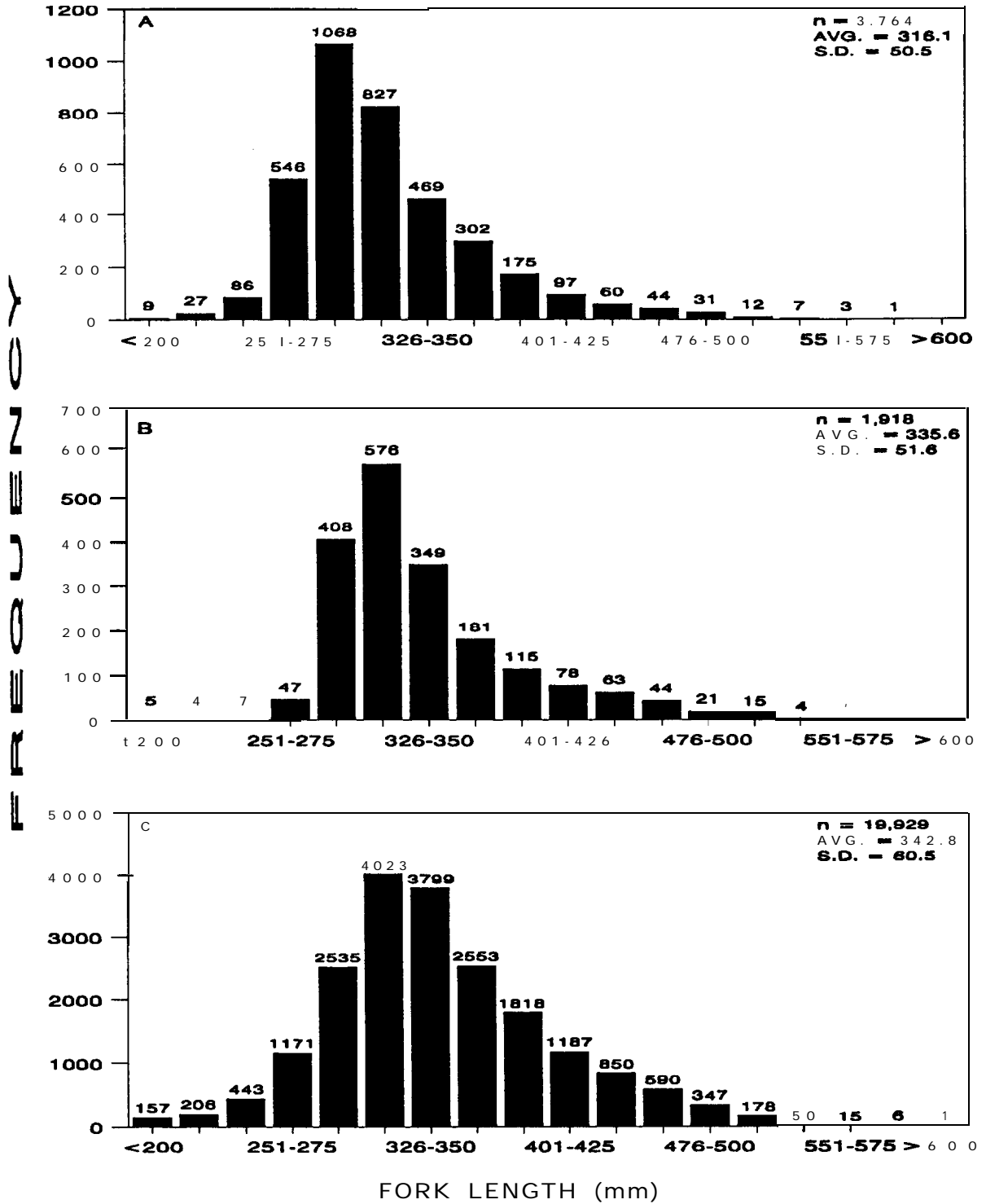

Figure 14. Length frequency distribution of northern squawfish by reservoir, during May 24-September 22, 1991; Lower Monumental Res. (A), Little Goose Res. (B), and Lower Granite Res. (C).

Table 1. Total of all species of fish turned into the check stations excluding northern squawfish; total = number of fish turned in, #F.L.= number of fish fork length was measured from, AVG. = **average** fork length, S.D.= standard deviation.

SPECIES	total	#F.L.	AVG.	S.D.
American shad	6	4	410.0	10.0
brown bullhead	8	8	237.0	20.5
black crappie	44	25	238.4	43.7
bluegill	3	3	160.0	2.2
bullhead (general)	4	4	279.8	2.2
bull trout	1	1	390.0	0.0
bridgelip sucker	9	9	380.7	0.0
crappie (general)	23	23	235.6	21.9
channel catfish	453	220	416.3	83.1
chiselmouth	106	93	270.9	35.7
sculpin (general)	2	0	*****	*****
carp	6	3	527.0	61.7
Columbia river chub'	192	187	306.0	336.0
cutthroat trout	5	3	280.0	42.4
largemouth bass	3	2	310.0	30.0
largescale sucker	4	4	371.3	39.4
<b>peamouth</b>	368	308	262.1	42.6
pumpkinseed	1	1	146.0	0.0
rainbow trout (resident)	25	24	304.0	36.1
<b>redside</b> shiner	1	1	108.0	0.0
rainbow trout (unk.race)	20	19	267.1	24.1
starry flounder	2	2	171.5	8.5
steelhead (unk.race)	18	15	472.2	180.0
sucker (general)	11	7	410.1	18.8
smallmouth bass	770	573	290.9	58.9
steelhead (summer)	10	10	601.6	112.1
steelhead (winter)	1	0	*****	*****
<b>tench</b>	1	1	283.0	0.0
walleye	184	183	543.0	106.0
white crappie	20	15	238.0	12.8
mountain whitefish	3	3	341.0	24.3
<b>warmouth</b>	2	2	214.5	44.5
white sturgeon	9	8	1229.4	242.6
yellow perch	43	20	208.5	37.4

\* probable northern squawfish/chiselmouth hybrid; named Columbia river chub for reporting purposes.

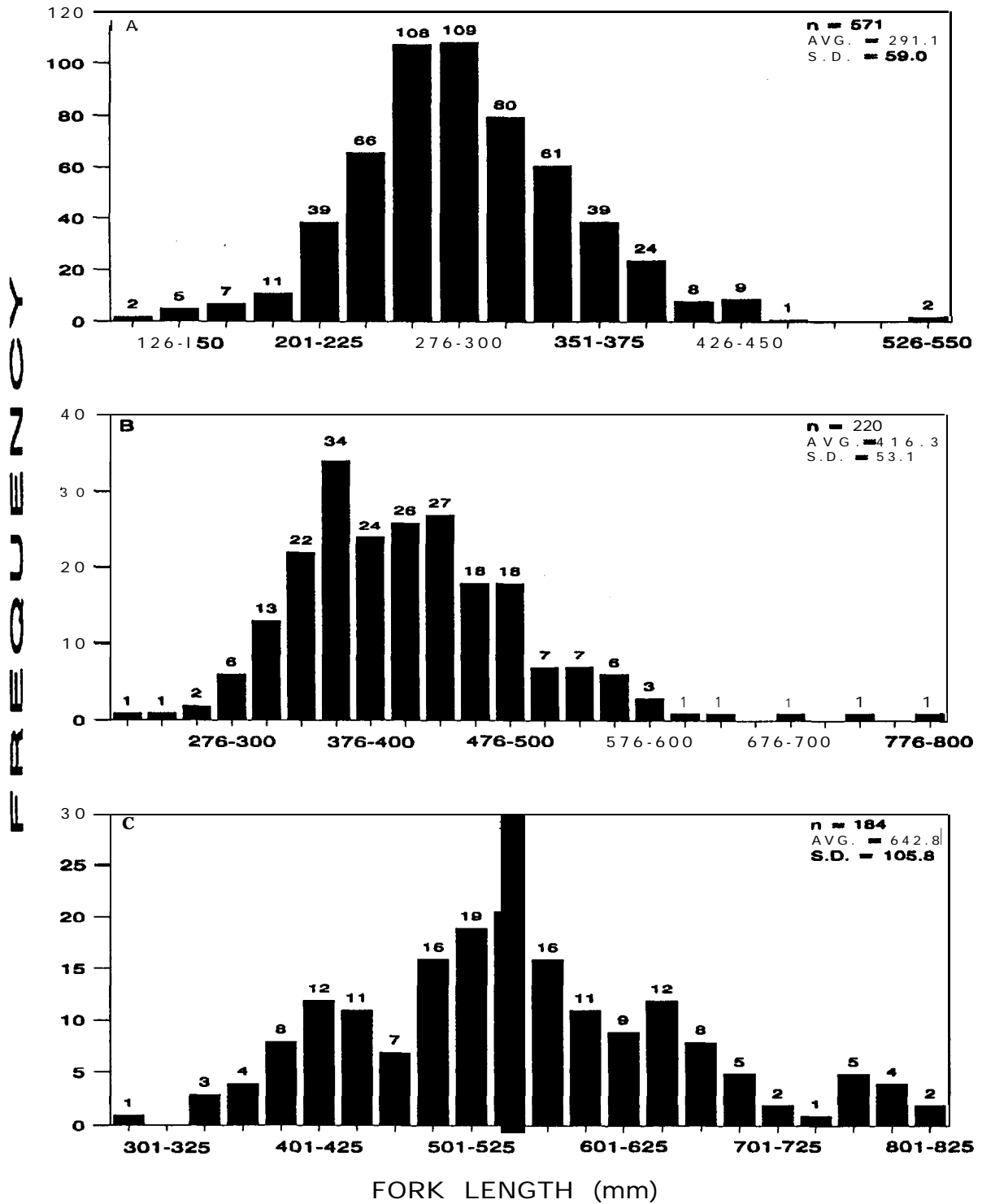

Figure 15. Length frequency distribution for smallmouth bass (A), channel catfish (B), and walleye (C), during May 24-September 22, 1991.



Table 2. Total effort by reservoir section for the season, SECT= reservoir section, N= number of effort observations, TOTAL EFFORT= effort for all observations by section, MEAN EFFORT= average effort by reservoir section, TOTEFFORT PER DAY= effort expanded to available fishing hours per day, SAMPLE FRACTION= N / total days available during the season, and TOTEFFORT PER SEASON= total effort by reservoir section for the season.

RCSEUROIR	SECT	N	TOTAL EFFORT	MEAN EFFORT	TOTEFFORT PER DAY	SAMPLE FRACT (N/103)	TOTEFFORT PER SEASON
BONN. TAI LRACE'	1	15	1480	99	1184	0.146	8130
BONNEVILLE	1	6	213	36	426	0.058	73 13
	2	12	53	4	53	0.117	455
	3	7	120	17	206	0.068	3027
	4	3	29	10	116	0.029	3903
	5	5	73	15	175	0.049	3609
THE OALLES	1	8	7	1	11	0.078	135
	2	4	5	1	15	0.039	386
	3	4	99	25	297	0.039	7648
	4	7	33	5	57	0.068	832
	5	10	684	68	821	0.097	8454
JOHN DAY	1	5	21	4	50	0.049	1038
	2	10	33	3	40	0.097	408
	3	8	10	1	15	0.078	193
	4	4	12	3	36	0.039	927
	5	6	184	31	368	0.058	6317
MCNARY	1	4	33	8	99	0.039	2549
	2	6	33	6	66	0.058	1133
	3	2	20	10	120	0.019	6 180
	4	6	77	13	154	0.058	2644
	5	3	68	23	272	0.029	9339
ICE HARBOR	1	4	59	15	177	0.039	4558
	2	6	47	8	94	0.058	16 14
	3	5	53	11	127	0.049	2620
	4	5	4	1	10	0.049	198
	5	4	48	12	144	0.039	3708
LWR. MONUMENTAL	1	4	6	2	18	0.039	464
	2	1	0	0	0	0.010	0
	3	3	26	9	104	0.029	357 1
	4	8	67	8	101	0.078	1294
	5	6	101	17	202	0.058	3468
LITTLE GOOSE	1	4	31	8	93	0.039	2395
	2	6	113	19	226	0.058	3880
	3	4	18	5	54	0.039	139 1
	4	3	20	7	80	0.029	2747
	5	4	22	6	66	0.039	1700
LOWER GRANITE	1	4	22	6	66	0.039	1700
	2	5	40	8	96	0.049	1978
	3	2	44	22	264	0.019	13596
	4	5	69	14	166	0.049	3411
	5	3	24	8	96	0.029	3296

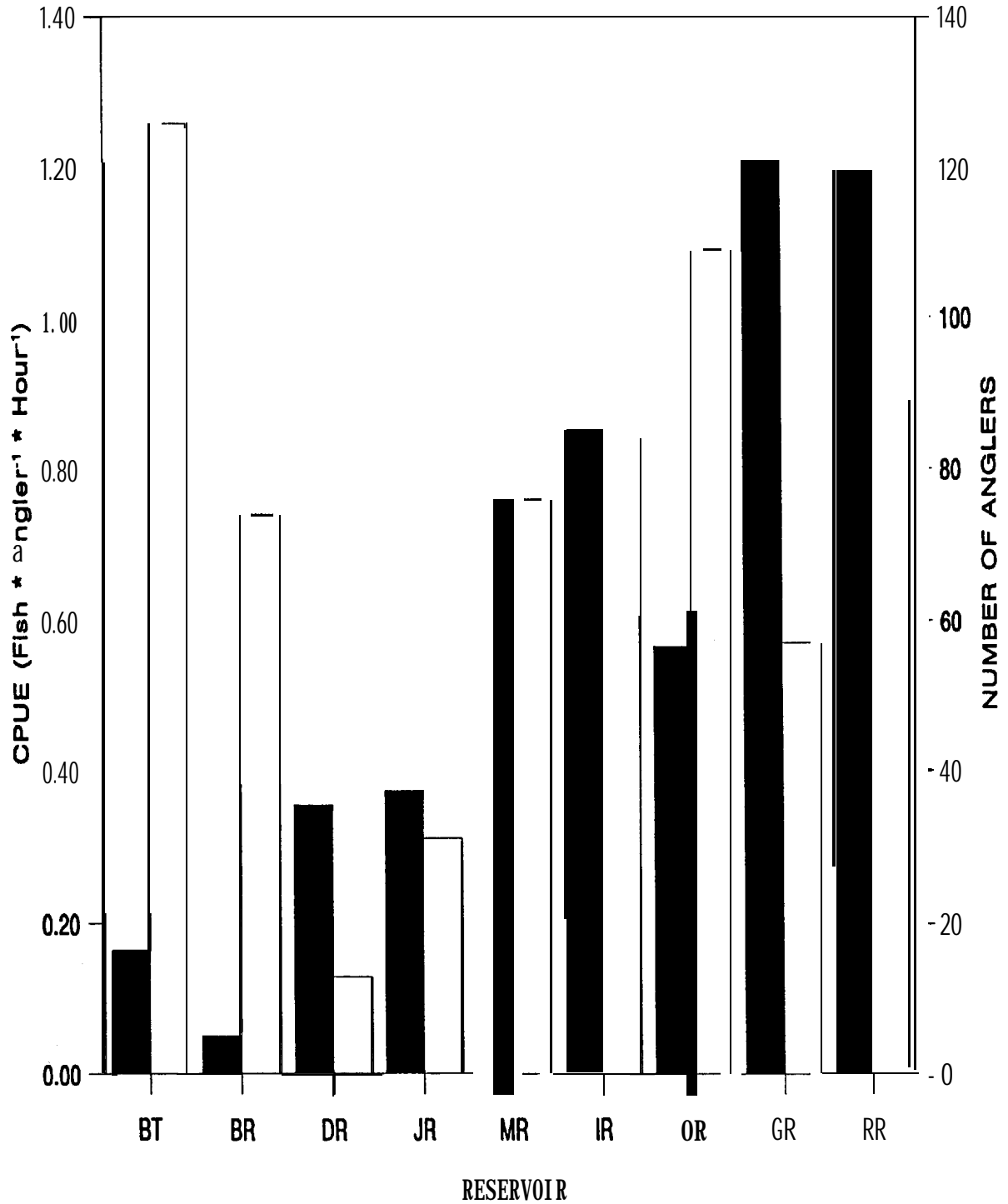

Figure 16. Number of anglers interviewed (□) and CPUE (■) by reservoir during June 11-September 21, 1991; BT= Bonneville Tailrace, BR= Bonneville reservoir, JR= John Day Reservoir, MR= McNary Reservoir, IR= Ice Harbor Reservoir, OR= Lower Monumental Reservoir, GR= Little Goose Reservoir, RR= Lower Granite Reservoir.

The relative catch estimates for species with more than 10 fish caught are presented in Figures 20. Smallmouth bass had the highest relative catch (45.8%).

## DISCUSSION

### Sport-Reward Fishery

The sport-reward fishery removing 159,162 northern squawfish came close to achieving the projected removals (171,420 northern squawfish 11 inches or longer) that were made after the 1990 Test Fishery (Vigg et al. 1991). This projection was based on full implementation (check stations in all reservoirs from May 24-September 22, 1991). The actual implementation varied from this plan. On May 24, 1991 nine check stations were open in seven of the nine areas, with the additional six check stations opening on July 15, 1991. Had all 15 check stations opened May 24 the projected removals of northern squawfish would most probably have been achieved.

The catch of northern squawfish in John Day Reservoir of 4,419 this year is very close to the 4,681 northern squawfish removed in this same reservoir in 1990 (Vigg et al. 1991). The overall CPUE for John Day Reservoir in 1991 was 0.47 fish \* angler-1 \* h<sup>-1</sup> compared to 0.58 fish \* angler-1 \* h<sup>-1</sup> in 1990. Continued monitoring of the CPUE over several years time will give us an indication of the relative success of the sport-reward fishery.

The majority of the northern squawfish were removed from the areas associated with the dams. One probable explanation for this would be that the access sites are located around these facilities. In future years this will be taken into consideration when locating check stations on the rivers.

During the season the catch of species other than northern squawfish showed the potential impacts that the fishery could have on these species. The fact that only 41.13% of the registered participants returned to the check stations indicates that the magnitude of the problem could be greater than the data shows at this time. The use of a roving creel survey could be used to quantify the impacts the sport-reward fishery is having on non-target fish species.

### Game Fish Survey Feasibility

We implemented a pilot game fish creel survey to determine the feasibility of this tool as a means to quantify the impact the Northern Squawfish Sport-Reward Fishery has on species of fish other than northern squawfish. Recognizing the limited man power available this year and thus the relatively small sample size we chose not to attempt an estimate of absolute catch, by species, by reservoir, but rather a relative catch, by species for each reservoir. The creel survey for 1992 is being designed and will be presented in the Final Draft 1992 Annual Report. This creel survey will also be compared to the mark recapture work that the ODFW is conducting to estimate walleye, smallmouth bass, and channel catfish exploitation rates.

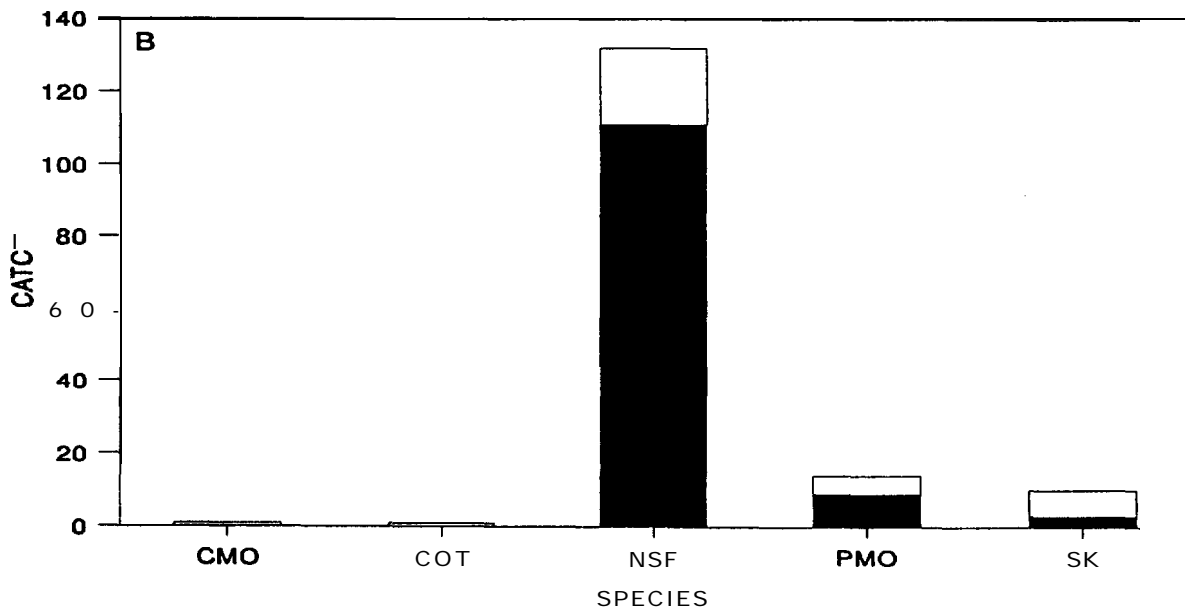
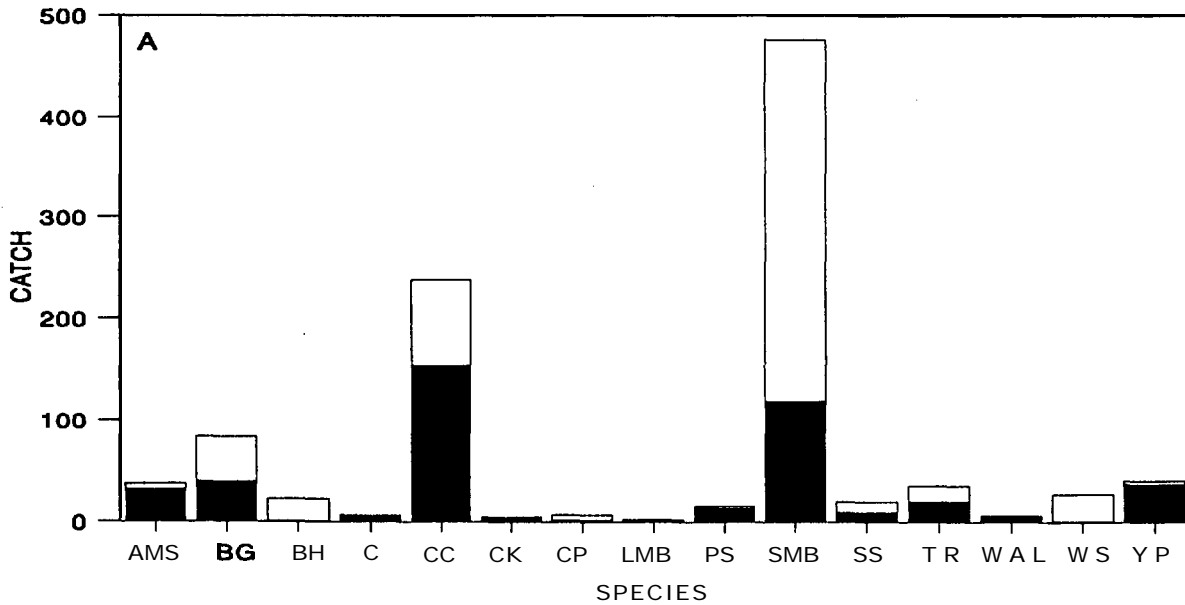

Figure 17. Catch composition of all fish species caught in the game fish survey, fish kept (■), fish released (□), game and food fish species (A), and unclassified fish species (B); AMS= American shad, BH= bullhead (unknown species), BG= bluegill, c= crappie, CC= channel catfish, CK= chinook salmon, COT= sculpin (unknown species), CP= carp, CMO= chiselmouth, LMB= largemouth bass, NSF= northern squawfish, PMO= peamouth, PS= pumpkinseed, SS= steelhead (summer run), SK= sucker (unknown species), SMB= smallmouth bass, TR= trout (unknown species), WAL= walleye, WS= white strugeon, and YP= yellow perch.

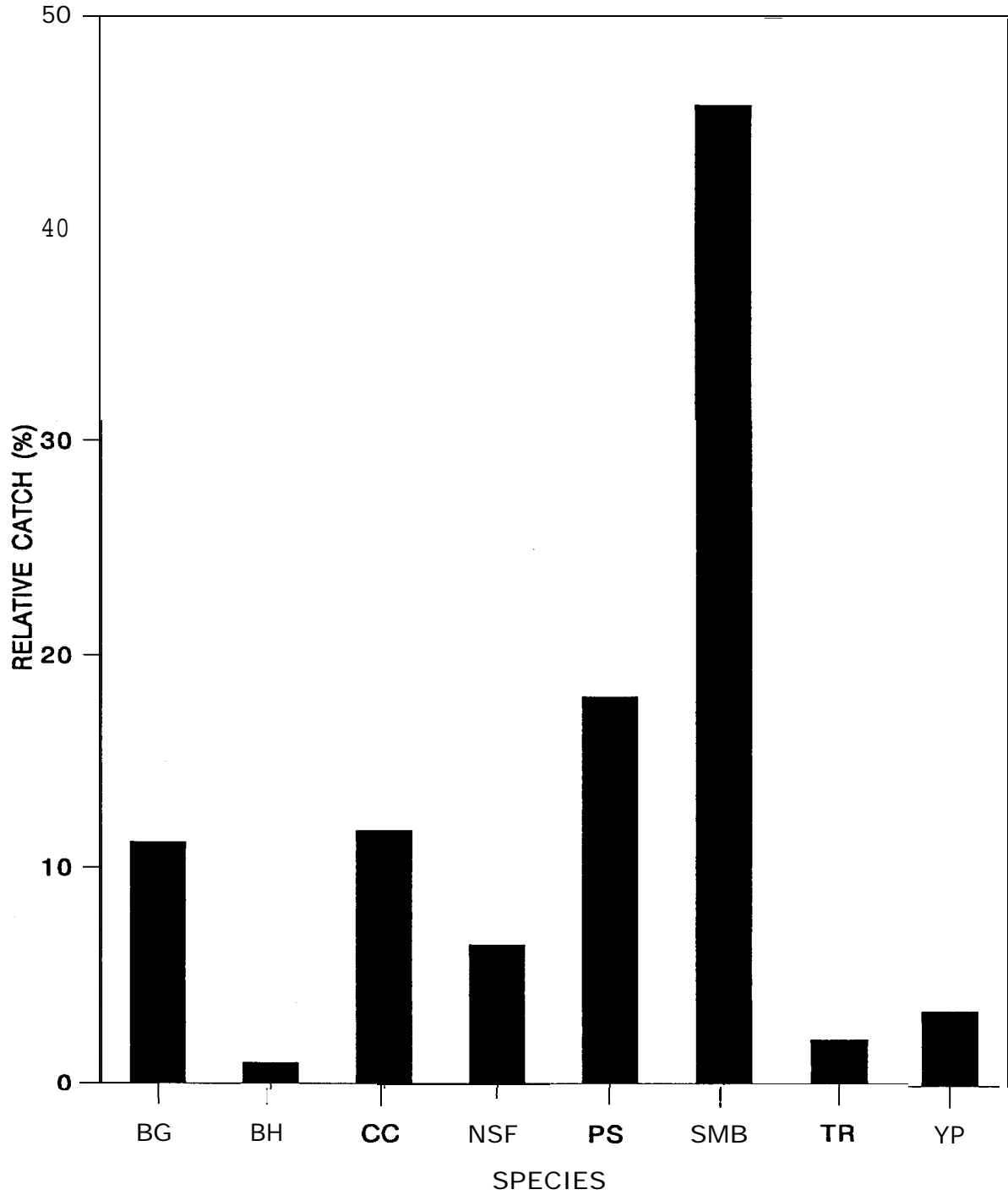

Figure 18. Relative catch for species of fish with 10 or more caught, all reservoirs combined, during June 11-September 21, 1991; **SMB**= smallmouth bass, **PS**= pumpkinseed, **CC**= channel catfish, **BG**= bluegill, **NSF**= northern squawfish, **YP**= yellow perch, **TR**= trout (unknown species), and **BH**= bullhead (unknown species).

## Recommendations For 1992 Sport-Reward Fishing Season

The process of conducting the registration/exit interview was improved from the process used in 1990, however there are still areas of improvement. During the peak removals of northern squawfish (mid to late June) and to a lesser extent throughout the season in the mornings and evenings, anglers were required to wait in line to participate in the program. This is a key issue that needs to be resolved if the program is to continue to draw large numbers of anglers. Several solutions are presented below.

- (1) The fishing season should be conducted from mid May to the end of September.
- (2) Open check stations from 9 a.m. to 9 p.m. (this can be achieved using a shuttle vehicle to transport personnel and fish to and from the check stations at start up, shutdown, and shift change).
- (3) Provide anglers the ability to self register during periods when the check stations are closed via a registration form and drop box.
- (4) Allow the registration to be valid for an angler registering from **9:01** p.m. the previous day to be good until 9:00 p.m. of the current day.
- (5) The angler must check in northern squawfish at the same station that he/she is registered at.
- (6) A minimum of two personnel at each check station at all times (for increased data processing capabilities, reduced lines of anglers waiting to register or turn in fish, and for safety).
- (7) Provide for computerized registration, exit interview, and data collection. This will eliminate data errors during the transfer of data from hard copy to computer file, reduce the processing time of registration by having return anglers on file, and reduce the time necessary to report on in-season progress of the fishery.
- (8) The check station at Chief Timothy State Park should be relocated to Boyer Park. This is in response to the lack of participation at Chief Timothy, and requests from anglers to have a check station at Boyer Park.
- (9) Provide additional check stations: one above the Tri Cities in Ringold; two in the Portland/Vancouver area; and two in the Longview/Rainier area.

## SUMMARY

(1) We conducted the Northern Squawfish Sport-Reward Fishery from May 24-September 22, 1991. Nine check station sites were opened on May 24, 1991. The additional six check stations were opened July 15, 1991.

(2) A total of 33,566 participants registered to fish for northern squawfish at the check stations. The returning anglers expended a total 24,186 angler days or 144,710 angler hours to catch 159,162 northern squawfish 11 inches or longer.

(3) Of the participants that registered 41.13% returned after their fishing trip. The impacts of the non-returning 58.87% of the registered participants on other species of fish needs to be addressed. One approach would be to conduct a roving creel survey in the same areas that the sport-reward fishery is being conducted. An estimate of the harvest ratio of other fish species by participants and non-participants in the sport-reward fishery could be derived, thus assessing the relative impact the sport-fishery has on non-target species especially sensitive salmonid stocks.

(4) A feasibility study was conducted to develop a creel survey to estimate harvest of selected fish species in the same area of the Northern Squawfish Sport-Reward Fishery.

(5) Mechanisms were identified to improve the process of registering anglers to participate in the sport-reward fishery program and will be proposed for the 1992 fishing season:

- (a) Check stations opened from 9:00 a.m. to 9:00 p.m.
- (b) Anglers are allowed to fish 24 hours a day.
- (c) Self registration available during those periods when the registration site is closed.
- (d) Provide for computerized registration, exit interview, and biological data collection.
- (e) Provide for computerized file of participants to eliminate re-entry of registration data into data base.
- (f) Relocate Chief Timothy State Park check station to Boyer Park.
- (g) Provide additional check stations: one above the Tri Cities in Ringold; two in the Portland/Vancouver area; and two in the Longview/Rainier area.

## REFERENCES

- Malvestuto, S. P., W. D. Davies, and W. L. Shelton. 1978. An evaluation of the roving creel survey with non-uniform probability sampling. *Transactions of the American Fisheries Society* 107:255-262.
- NCCP (Northwest Power Planning Council). Columbia River Basin Fish and Wildlife Program. Adopted November 15, 1982, amended October 10, 1984, and February 11, 1987. Northwest Power Planning Council, Portland, Oregon.
- Orsatti, S., N. P. Lester, and M. E. Daniels. CREESYS: A Software System for Management of Ontario Creel Survey Data. (unpublished manuscript).
- Poe, T. P., and B. E. Rieman, editors. 1988. Predation by resident fish on juvenile salmonids in John Day Reservoir, Volume I-Final Report of research. (Contracts DE-A179-82BP34796 and DE-A179-82BP35097) Bonneville Power Administration, Portland, Oregon.
- Rieman, B. E., and R. C. Beamesderfer. 1990. Dynamics of a northern squawfish population and the potential to reduce predation on juvenile salmonids in a Columbia River reservoir. *North American Journal of Fisheries Management* 10:228-241.
- Vigg, S. and C. C. Burley. 1989. Developing a predation index and evaluating ways to reduce salmonid losses to predation in the Columbia Basin. Report A in A. A. Nigro, editor. Developing a predation index and evaluating ways to reduce losses to predation in the Columbia Basin. Oregon Department of Fish and Wildlife, Contract Number DE-A179-88BP92122. Annual Report to Bonneville Power Administration, Portland, Oregon.
- Vigg, S., C. C. Burley, D. L. Ward, C. Mallette, S. Smith, and M. Zimmerman. 1991. Development of a System-wide Predator Control Program: Stepwise Implementation of a Predation Index, Predator Control Fisheries, and Evaluation Plan in the Columbia River Basin. Report A in A. A. Nigro, editor. Development of a System-wide Predator Control Program: Stepwise Implementation of a Predation Index, Predator Control Fisheries, and Evaluation Plan in the Columbia River Basin. Oregon Department of Fish and Wildlife, Contract Number DE-B179-90BP07084. Annual Report to Bonneville Power Administration, Portland, Oregon.
- Zar, J. H. 1974. *Biostatistical Analysis*. Prentice-Hall, Inc. Englewood Cliffs, N.J.





## APPENDICES



Appendix A. Check station location codes (field offices in parentheses).

01= Hamilton Island Boat Ramp, WA (North Bonneville).

02= The Fishery at Covert's Landing, OR (North Bonneville).

03= Cascade Locks Marina, OR (North Bonneville).

04= Bingen Marina, WA (White Salmon).

05= Dalles Boat Basin, OR (White Salmon).

06= Maryhill State Park, WA (Goldendale).

07= LePage Park, OR (Goldendale).

08= Plymouth Boat Ramp, WA (Pasco).

09= Columbia Point Park, WA (Pasco).

10= Hood Park, WA (Pasco).

11= Windust Park, WA (Kahlotus).

12= Lyons Ferry State Park, WA (Starbuck).

13= Central Ferry State Park, WA (Starbuck).

14= Chief Timothy State Park, WA (Clarkston).

15= Greenbelt Boat Ramp, WA (Clarkston).



Appendix B. Examples of data forms used during the sport-reward fishery, and a list of the registration, exit, and biological data codes.

WASHINGTON DEPARTMENT OF WILDLIFE  
SPORT-REWARD FISHERY

--

DOCUMENT NUMBER

REGISTRATION

DATE			CLERK	LOC.
MO	DAY	YR	INIT.	

ANGLERS NAME																				
FIRST										MI	LAST									

TELEPHONE #						CONT.	LICENSE						
AREA	NUMBER					TIME	NUMBER					ST.	

TARGET SPECIES			FISHING	START
#1	#2	#3	TYPE	TIME

EXIT INTERVIEW

CLERK INIT.	STOP TIME	HOURS FISHED	NUMBER ANGLERS	LOCATION FISHED

WDFW Form 10-91

NUMBER SQUAWFISH								
# PAY	# < 11 in.	# LOST						

--

VOUCHER NUMBER

Figure 8.1. Northern squawfish sport-reward fishery registration and exit interview data form.

WASHINGTON DEPARTMENT OF WILDLIFE  
 NORTHERN SQUAWFISH SPORT-REWARD FISHERY  
 BIOLOGICAL DATA COLLECTION FORM

CLERK INITIALS	WEATHER	TOTAL WEIGHT (lb)

LINE NUMBER	SPECIES	FORK LENGTH (mm)	WEIGHT (g)	FISH DISPOSITION	SCALE	SEX	MATURITY	TAG NUMBER	TAG COLOR	S. MARK	GONAD	GONAD WEIGHT (g)	COMMENTS
1													
2													
3													
4													
5													
6													
7													
8													
9													
0													
1													
2													
3													
4													
5													
6													
7													
8													
9													
0													
1													
2													
3													
4													
5													

Figure 8.2. Northern squawfish sport-reward fishery biological data collection form.



**SPORT REWARD VOUCHER**

**Name:** \_\_\_\_\_  
**Street:** \_\_\_\_\_  
**City:** \_\_\_\_\_  
**state, ZIP:** \_\_\_\_\_

MO	DAY	YR	DOCUMENT #	SOCIAL SECURITY #
<input type="text"/>	<input type="text"/>	<input type="text"/>	<input type="text"/>	<input type="text"/>

**NUMBER OF QUALIFYING SQUAWFISH:**

**TOTAL REWARD:** \$  **VOUCHER #:**

**SIGNATURES:**

\_\_\_\_\_  
Creel Clerk

\_\_\_\_\_  
**Angler**  
(Signed in Presence of Creel clerk)

Figure B.3. Northern squawfish sport-reward fishery voucher form.

Members of a single household fishing and submitting voucher together: Main angler in household answer questions for entire household. Members of separate households fishing individually or together, submitting separate vouchers: Each registered angler should answer questions for him/her self. (If group expenditures made for #7,8,9, enter amount of your individual expenditure only.)

**PLEASE FILL IN OR CIRCLE THE APPROPRIATE ANSWER**

- |  |   |
|--|---|
| <p>1. Number of anglers in your party:<br/>            ___ PEOPLE</p> <p>2. Number of hours spent fishing for squawfish: ___ HRS (PER PERSON)</p> <p>3. Miles traveled (one way) to fish at this reservoir:<br/>            1. &lt;20                   4. 60-79<br/>            2. 20-39                 5. 80-99<br/>            3. 40-59                 6. 100 or more</p> <p>4. If staying away from home, number of days you stayed in the area this trip:<br/>            1. &lt;1                   5. 4<br/>            2. 1                     6. 5<br/>            3. 2                     7. &gt;5<br/>            4. 3</p> <p>5. If you stayed overnight, type of accomodation:<br/>            1. MOTEL<br/>            2. STATE PARR<br/>            3. NATIONAL PARK CAMPGROUND<br/>            4. PRIVATE CAMPGROUND<br/>            5. FRIEND OR RELATIVE<br/>            6. OTHER (please specify)<br/>            _____</p> <p>6. Total amount spent on accomodations:<br/>            _____</p> <p>7. Approximate amount spent to purchase food on this trip:<br/>            1. RESTAURANTS: \$ _____<br/>            2. GROCERY STORE: \$ _____<br/>            3. OTHER (please specify)<br/>            _____</p> <p>8. other expenditures In the area:<br/>            1. GAS: \$ _____<br/>            2. FISHING SUPPLIES: \$ _____<br/>            3. BAIT: \$ _____<br/>            4. OTHER (please specify):<br/>            _____</p> | <p>9. Primary method you/(your party) used: (circle only one)<br/>            1. BOAT, ANCHORED<br/>            2. BOAT, DRIFTING<br/>            3. BOAT, TROLLING<br/>            4. SHORE<br/>            5. ANGLING, SURFACE<br/>            6. ANGLING, BOTTOM<br/>            7. OTHER (please specify): _____</p> <p>10. Primary bait or tackle you/(your party) used: (circle only one)<br/>            1. WORMS<br/>            2. CUT FISH BAIT<br/>            3. SPINNERS<br/>            4. SPOONS<br/>            5. FLATFISH<br/>            6. SURFACE PLUGS<br/>            7. HOOK AND LINE WITH 1 HOOK<br/>            8. HOOK AND LINE WITH &gt;1 HOOK<br/>            9. OTHER (please specify): _____</p> <p>11. Approximate purchase price of primary tackle used:<br/>            \$ _____</p> <p>12. Primary reason for this trip: (circle only one)<br/>            1. SQUAWFISH<br/>            2. OTHERFISH<br/>            3. COMBINATION OF OTHER FISH/<br/>               SQUAWFISH<br/>            4. NONFISHING ACTIVITY<br/>            5. OTHER (please specify)<br/>            _____</p> <p>13. Have you fished for squawfish before?<br/>            1. YES<br/>            2. NO</p> <p>14. Have you ever caught squawfish while fishing for another species?<br/>            1. YES, OFTEN<br/>            2. YES, OCCASIONALLY<br/>            3. NO</p> |
|--|---|

Figure B. 3 . . Continued.

15. What did you most **often** do with the **squawfish** you **caught before?** (Circle only one)  
 1. **ATE**  
 2. GAVE AWAY FOR OTHERS TO EAT  
 3. **FED TO ANIMALS**  
 4. USED AS **FERTILIZER**  
 5. THREW AWAY  
 6. RELEASED BACK **TO RIVER**  
 7. OTHER (please **specify**): \_\_\_\_\_
16. Have **you** ever **eaten squawfish** in any form?  
 1. YES  
 2. NO
17. **If answer to #16 is yes, how would you rate squawfish quality** (taste and texture)?  
 1. VERY SATISFACTORY  
 2. **SATISFACTORY**  
 3. UNSATISFACTORY
18. How **many fishing** trips do **you usually make per year?**  
 1. 0                      **5. 16-20**  
 2. **1-5**                    6. 21-25  
 3. **6-10**                 7. **>25**  
 4. **11-15**
19. Of **these trips, number** in **this reservoir:**  
 1. 0                      **5. 16-20**  
 2. **1-5**                    6. **21-25**  
 3. 6-10                 7. **>25**  
 4. **11-15**
20. **Yam** you **have fished** at **this reservoir:**  
 1. **<1**                    3. 4-s  
 2. 13                     4. **>5**
21. **State of residence:**  
 1. OREGON  
 2. WASHINGTON  
 3. IDAHO  
 4. OTHER (please **specify**): \_\_\_\_\_
22. **Age:**  
 1. **14-20**                                      **5. 51-60**  
 2. **21-30**                                      6. **61-70**  
 3. 31-40                                        7. **>70**  
 4. **41-50**
23. **Any problems encountered while fishing:**  
 1. ON BOAT **RAMP** (please **specify**): \_\_\_\_\_  
 \_\_\_\_\_  
 \_\_\_\_\_  
 2. ON WATER (please **specify**): \_\_\_\_\_  
 \_\_\_\_\_  
 \_\_\_\_\_
24. How **did you hear** about the **squawfish bounty program?**  
 1. NEWSPAPER  
 2. RADIO  
 3. TV  
 4. WORD OF MOUTH  
 5. **STATE FISHERY AGENCY**  
 6. **OTHER** (please **specify**) \_\_\_\_\_  
 \_\_\_\_\_
25. what **is your opinion** of **this fishing experience?**  
 1. SATISFIED  
 2. INDIFFERENT  
 3. NOT SATISFIED
26. COMMENTS:  
 \_\_\_\_\_  
 \_\_\_\_\_  
 \_\_\_\_\_  
 \_\_\_\_\_

**THANK YOU FOR YOUR HELP AND TIME.**

Figure B.3. Continued.

Table B.1. Registration interview codes, exit interview codes, and biological data codes.

Registration codes:

1. Month, day & year (MMDDYY)
2. Creel clerk initials
3. Check station location code (see location code sheet)
4. Anglers name (first, middle initial, last)
5. Telephone number (area code and number)
6. Best contact time (if needed for follow up questions)  
D= Day  
E= Evening
7. Fishing license number (anglers are not required to have a license to fish for northern squawfish in Washington, anglers fishing in Oregon waters or from the shore of the Columbia River are required to have a valid Oregon fishing license).
8. Target Species (see species code sheet)  
i. e., NSF= northern squawfish
9. Fishing type:  
0001= boat  
0002= bank
10. Start time (time angler registered at the check station)  
military time

Exit interview codes:

1. Clerk initials (these could be different from registration initials if the angler returned after the shift change)
2. Stop time (time angler is back at check station)
3. Hours fished (actual time spent fishing)
4. Number of anglers (number of anglers in the party)
5. Location fished (see location fished codes)
6. # pay (number of squawfish turned in 11 in. and longer)
7. # <11 in. (number of squawfish less than 11 in.)
8. # lost (number of squawfish released or broke off)
9. Voucher number (unique number on voucher form)

Biological data codes:

1. Clerk initials
2. Weather:  
001= sunny  
002= partly cloudy  
003= overcast  
004= rain
3. Total weight: (NSF > 11 in., lbs. to the nearest 1/10 lb.)
4. Species: (see species codes)
5. Fork length: ( $\pm$  1 mm.)
6. Weight: ( $\pm$  grams)
7. Fish disposition:  
01= 11 in. and longer turned in to creel clerk  
02= less than 11 in. turned in to creel clerk  
03= 11 in. and longer kept by angler  
04= less than 11 in. kept by angler  
05= other (explain in comments section)

8. Scales: (were scale samples taken?)
  - Y= yes
  - N= no
9. Fish sex: (not to be taken by WDW unless instructed)
  - M= male
  - F= female
  - U= undetermined
10. Maturity: (not to be taken by WDW unless instructed)
  - 0= not determined
  - 1= immature--gonads are thin or thread like; females show a greater degree of venation than males.
  - 2= developing--sex is easily determined from gonads (testes are white; ovaries are yellowish, tinged with red), but eggs or milt do not flow freely with gentle pressure.
  - 3= ripe--eggs or milt flow freely with gentle pressure.
  - 4= spent--sex is easily determined but gonads are flaccid and may show striations; some eggs or sperm may be present.
11. Tag number: (numbers are right justified)
  - 5 digit number enter as: 0055555 (these will be common)
  - 6 digit number enter as: 0666666 (these will be rare)
  - 7 digit number enter as: 7777777 (these are also rare)
12. Tag color:
  - P= pink
  - B= blue
  - R= red
  - G= green
  - W= white
  - 0= other (use comments section)
13. Secondary mark:
  - 0= none
  - 1= left pectoral
  - 2= right pectoral
  - 3= left ventral
  - 4= right ventral
  - 5= other (use comments section)
14. Gonad: (not to be taken by WDW unless instructed)
  - Y= yes
  - N= no
15. Gonad weight: (not to be taken by WDW unless instructed)  
weighed fresh in field to nearest 0.1 g.
16. Comments: (any additional information that could be used)

Table B-1. Continued fish species.

LMB	Bass, Largemouth
RKB	Bass, Rock
SMB	Bass, Smallmouth
SB	Bass, Striped
BG	Bluegill
BH	Bullhead (General)
YBH	Bullhead, Yellow
BBH	Bullhead, Brown
BLB	Bullhead, Black
CP	Carp
BCF	Catfish, Blue
cc	Catfish, Channel
FCF	Catfish, Flathead
AC	Char, Atlantic
C	Crappie (General)
BC	Crappie, Black
WC	Crappie, White
EUL	Eulachon
SF	Flounder, Stary
AG	Grayling, Artic
TMK	Musky, Tiger
SP	Perch, Shiner
YP	Perch, Yellow
NP	Pike, Northern
PS	Pumpkinseed
AT	Salmon, Atlantic
CK	Salmon, Chinook
CH	Salmon, Chum
co	Salmon, Coho
K	Salmon, Kokanee
SA	Salmon, Pacific Unknown
PK	Salmon, Pink
so	Salmon, Sockeye
AMS	Shad, American
LFS	Smelt, Longfin
ss	Steelhead, Summer-run
SW	Steelhead, Winter-run
SH	Steelhead, Unknown race
GRS	Sturgeon, Green
ws	Sturgeon, White
S	Sunfish (General)
GS	Sunfish, Green

Table B-1. Continued fish species codes.

BT	Trout, Brown
CT	Trout, Cutthroat General Unknown
CCT	Trout, Cutthroat Coastal Resident
SCT	Trout, Cutthroat Coastal Sea-run
LCT	Trout, Cutthroat Lohontan
WCT	Trout, Cutthroat West Slope
DB	Trout, Dolly Varden/Bull Unknown
BLC	Trout, Bull Trout (Char)
DVC	Trout, Dolly Varden (Char)
EB	Trout, Eastern Brook
GT	Trout, Golden
LT	Trout, Lake
RB	Trout, Rainbow Resident
RU	Trout, Rainbow Unknown
TR	Trout, Unkown
WAL	Walleye
WM	Warmouth
LW	Whitefish, Lake
WF	Whitefish, Mountain

Non-game fish species

BUR	Burbot
CMO	Ciselmouth
LCH	Chub, Lake
TCH	Chub, Tui
CRC	Chub, Columbia River (CMO-NSF Hybrid Cross) *
LED	Dace, Leopard
SD	Dace, Longnose
GF	Goldfish
LM	Lamprey (General)
PL	Lamprey, Pacific
RL	Lamprey, River
WL	Lamprey, Western Brook
MQF	Mosquitofish
OMM	Mudminnow, Olympic
PMO	Peamouth
P	Pickerel, Grass
SAN	Sandroller
COT	Sculpin, (General)
css	Sculpin, Coastrange
MRS	Sculpin, Margined
MTS	Sculpin, Mottled
PSS	Sculpin, Pacific Staghorn
PTS	Sculpin, Piute
PRS	Sculpin, Prickly

Table B-1. Continued fish species codes.

RTS	Sculpin, Reticulate
RFS	Sculpin, Riffle
SHS	Sculpin, Shorthead
SLS	Sculpin, Slimy
TRS	Sculpin, Torrent
RS	Shiner, Redside
NSF	Squawfish, Northern
TSS	Stickelback Three-spine
SK	Sucker, (General)
BRS	Sucker, Bridgelip
LRS	Sucker, Largescale
LNS	Sucker, Longnose
MNS	Sucker, Mountain
TMT	Tadpole, Madtom
TNC	Tench
WAD	White Amur-diploid
WAT	White Amur-triploid
PGW	Whitefish, Pygmy

\* used by sport-reward to describe hybrid crosses of northern squawfish with chiselmouth and peamouth.





Appendix C. Maps showing fishing locations and codes for the **1991** Northern Squawfish Sport-Reward Fishery.

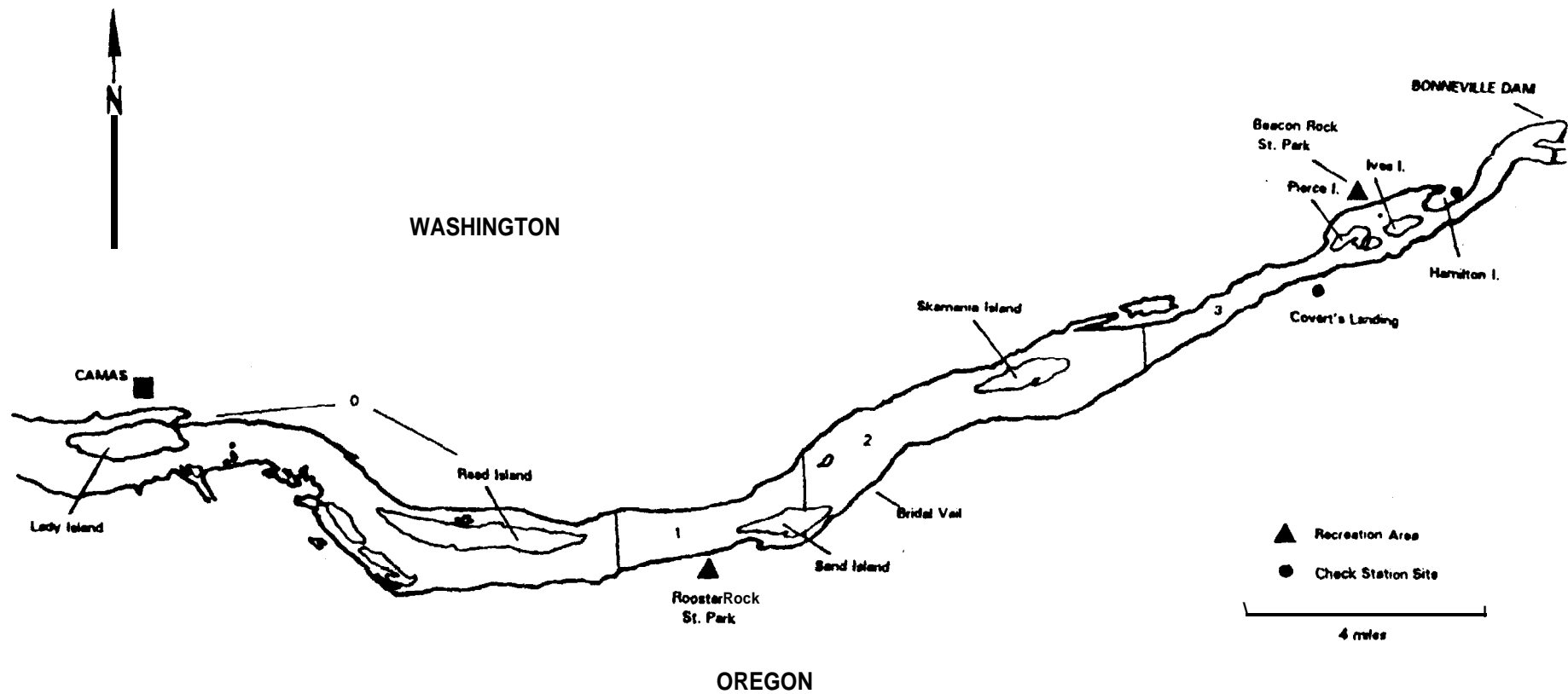

Figure C-1. Northern squawfish sport-reward fishery angler fishing location codes, Lady Island to Bonneville Dam, 1991.

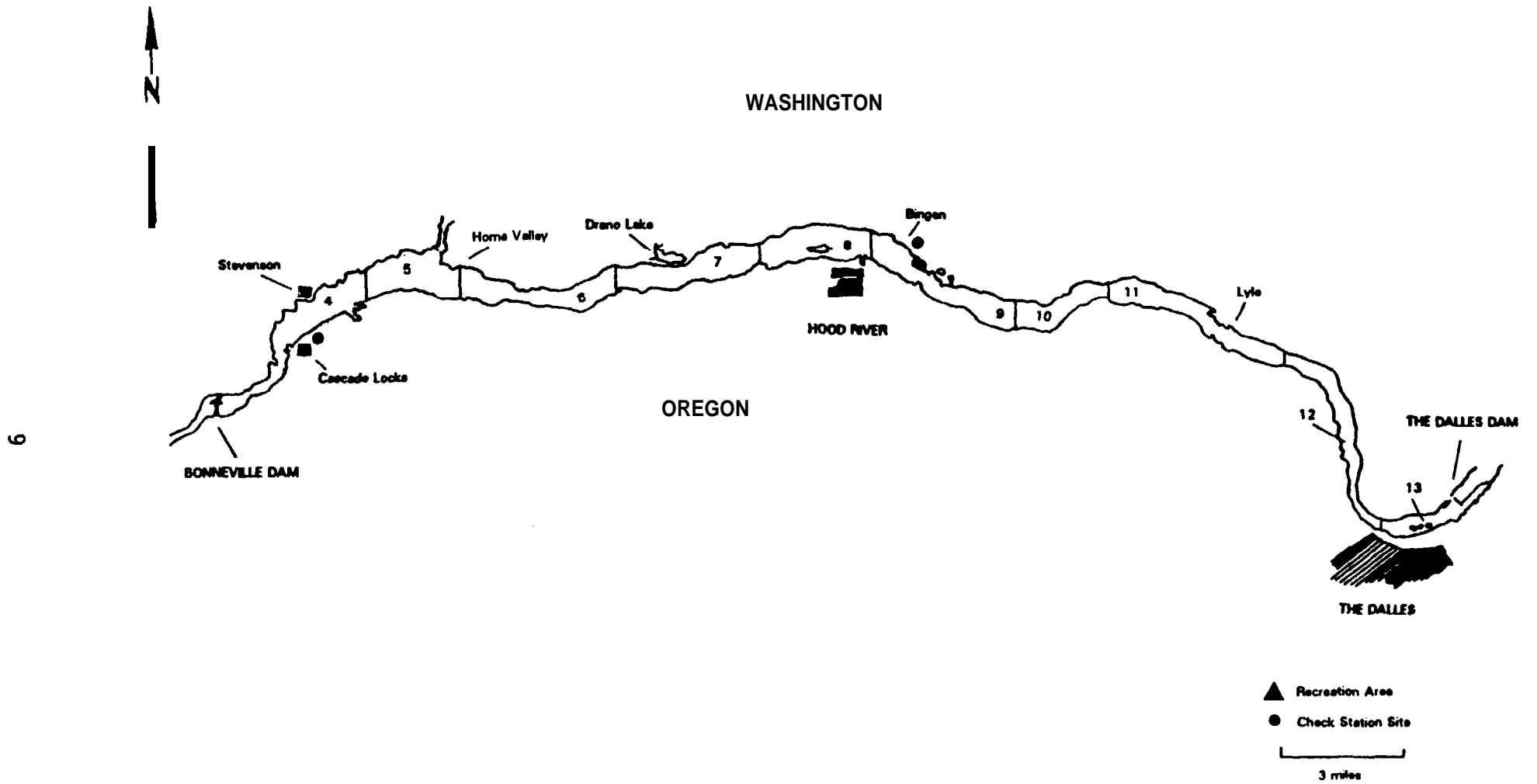

Figure C-2. Northern squawfish sport-reward fishery angler fishing location codes, Bonneville Dam to The Dalles Dam, 1991.

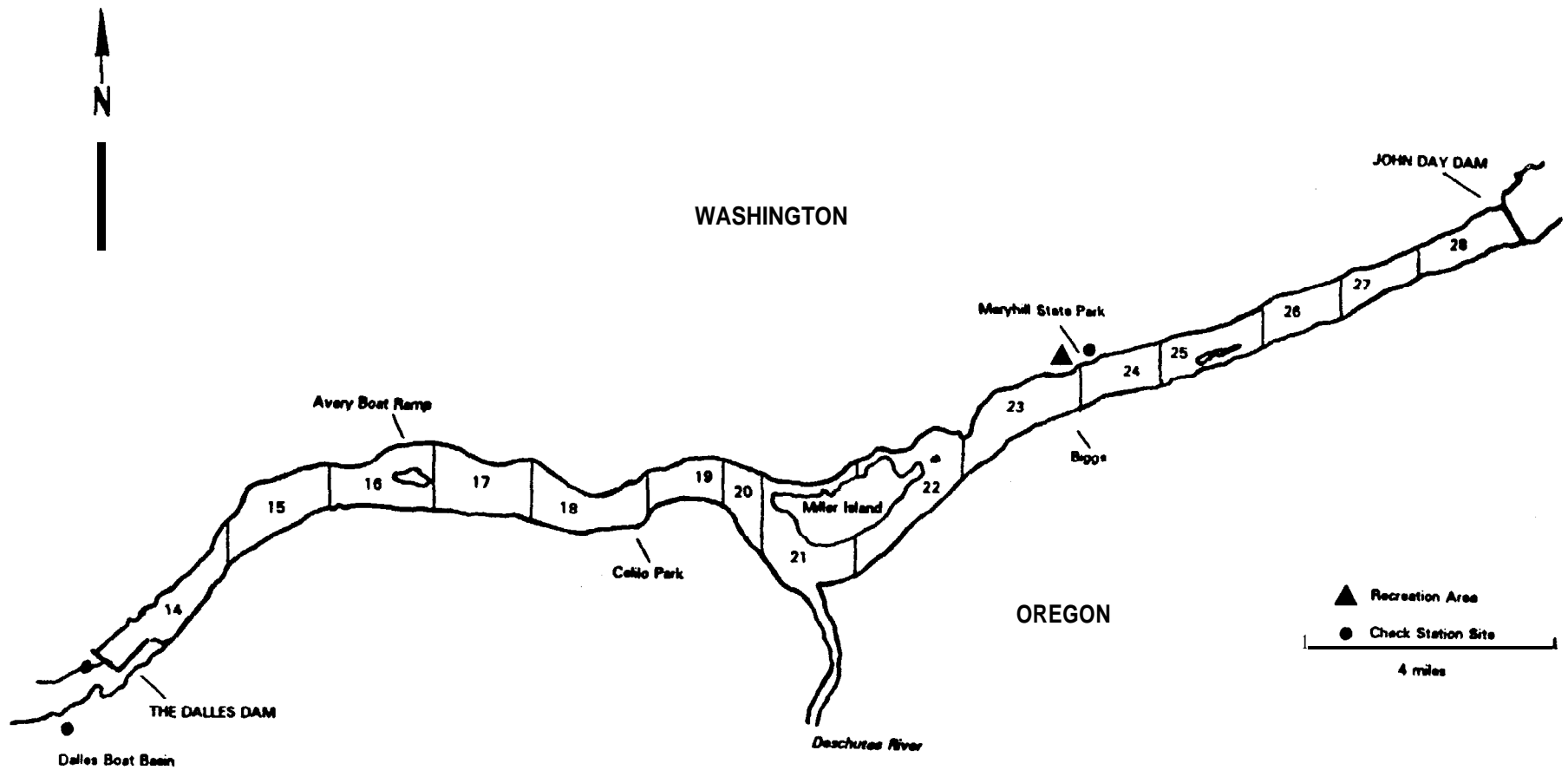

Figure C-3. Northern squawfish sport-reward fishery angler fishing location codes, The Dalles Dam to John Day Dam, 1991.

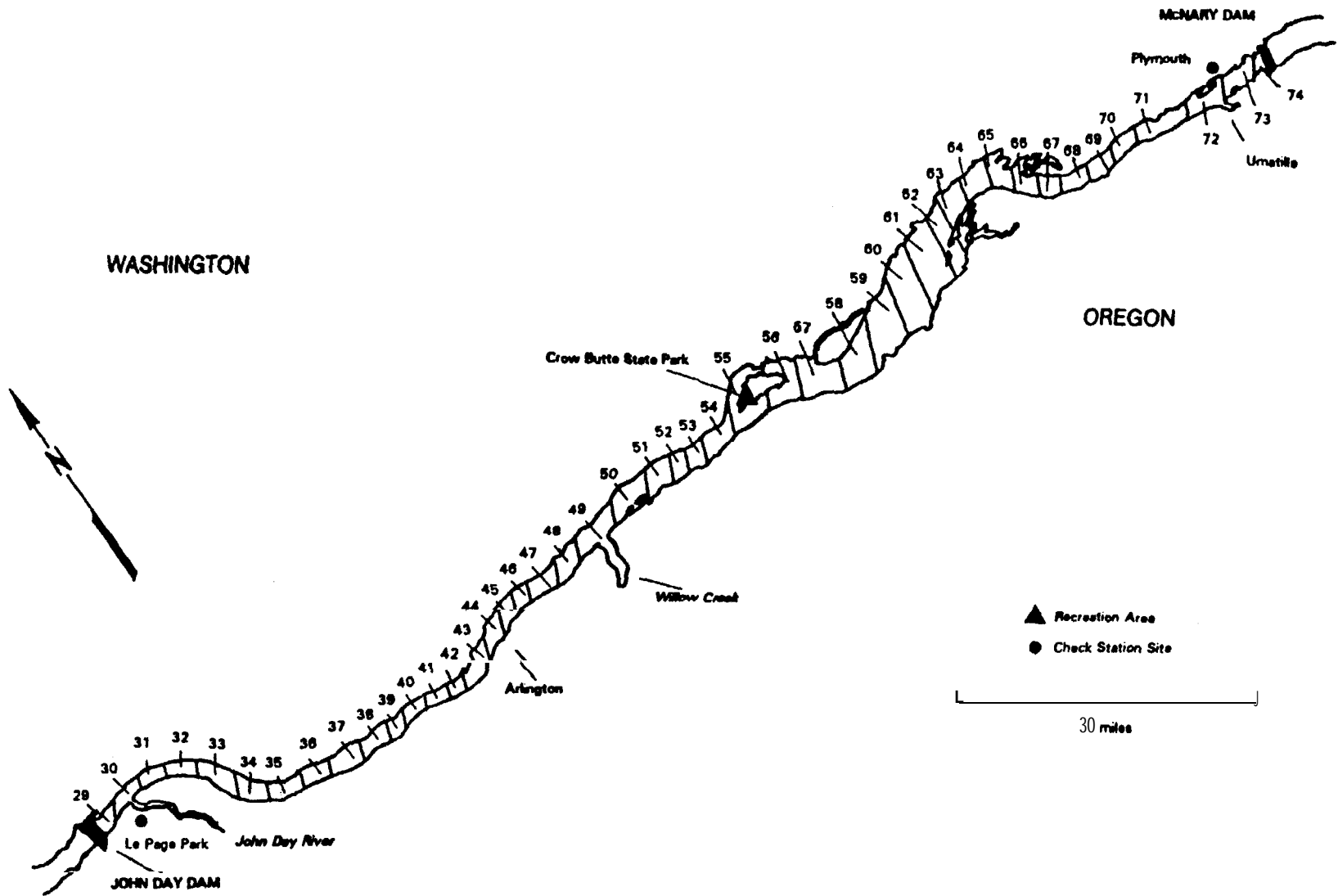

Figure C-4. Northern squawfish sport-reward fishery angler fishing location codes, John Day Dam to McNary Dam, 1991.

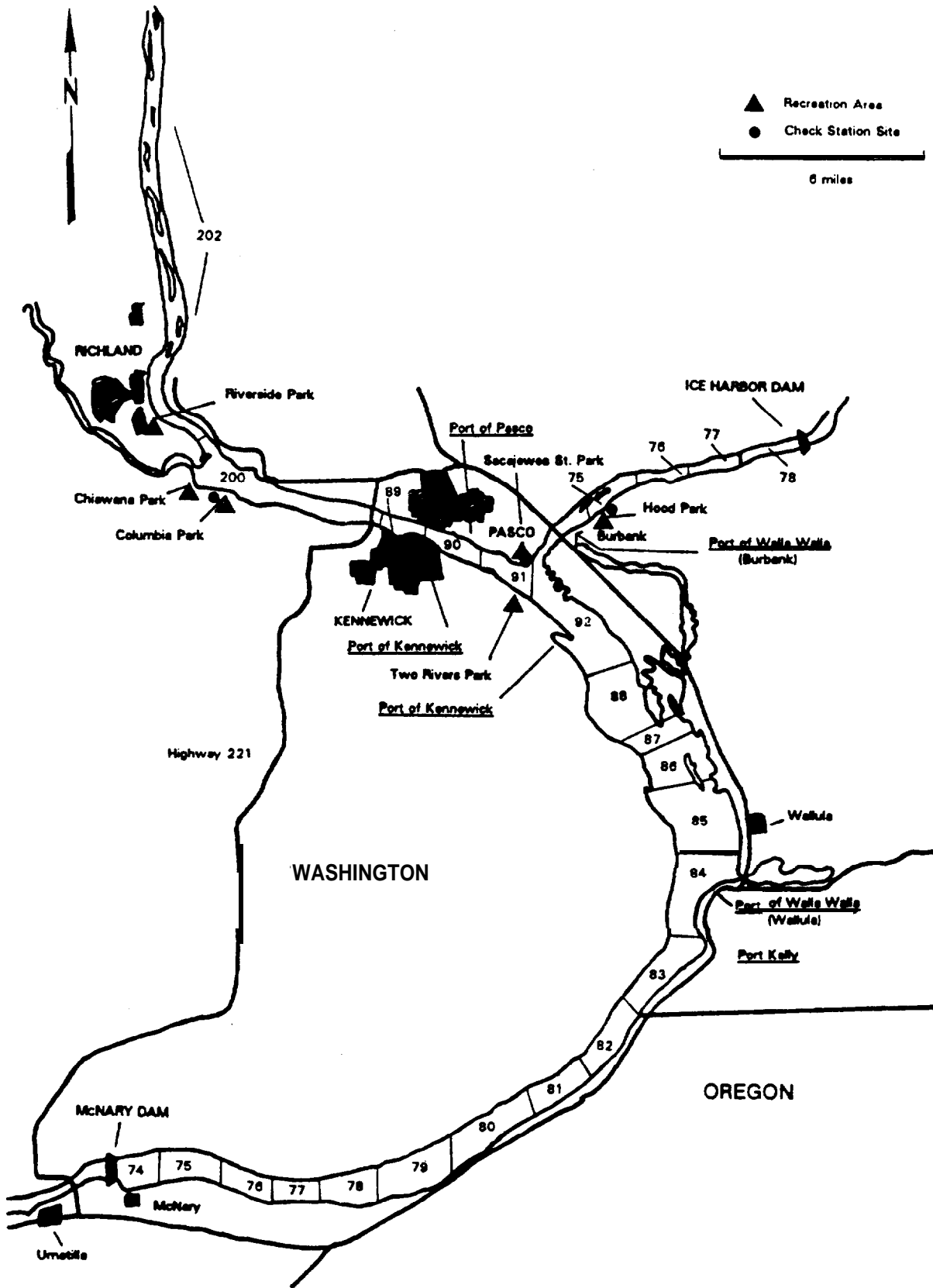

Figure C-5. Northern squawfish sport-reward fishery angler location codes, McNary Dam to Ringold, WA. on the Columbia River and to Ice Harbor Dam on the Snake River, 1991.

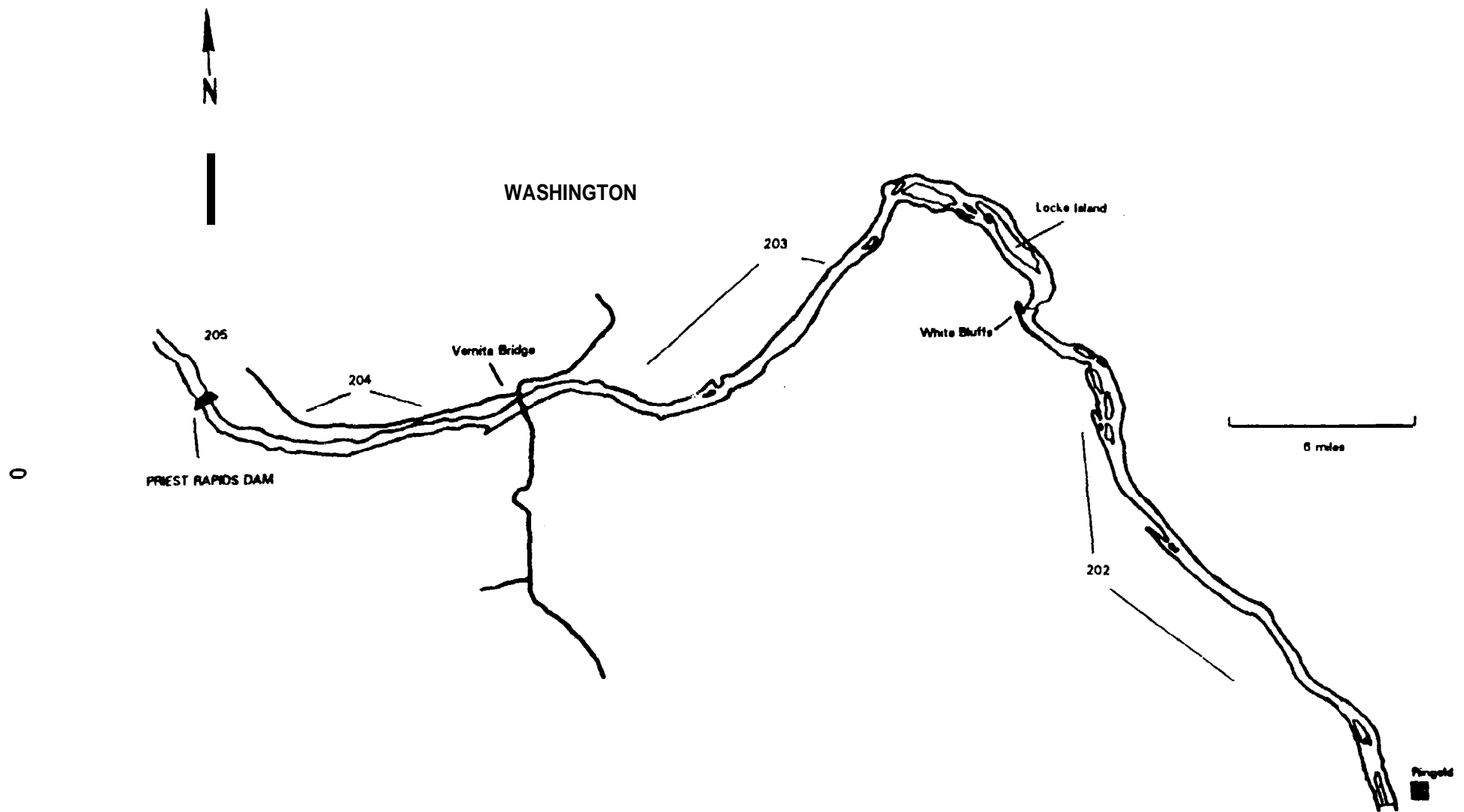

Figure C-6. Northern squawfish sport-reward fishery angler fishing location codes, Ringold, WA. to Priest Rapids Dam, 1991.



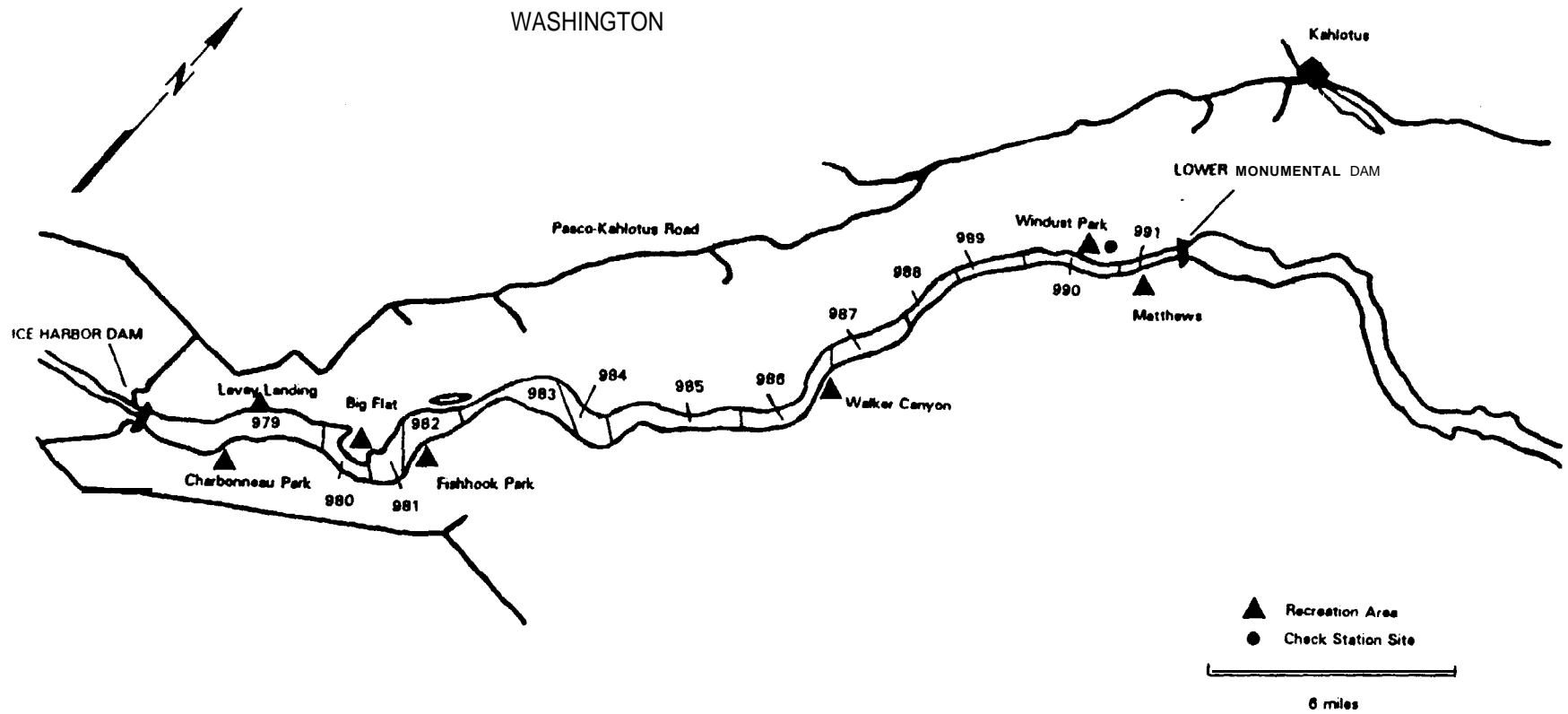

Figure C-7. Northern squawfish sport-reward fishery angler fishing location codes, Ice Harbor Dam to Lower Monumental Dam, 1991.

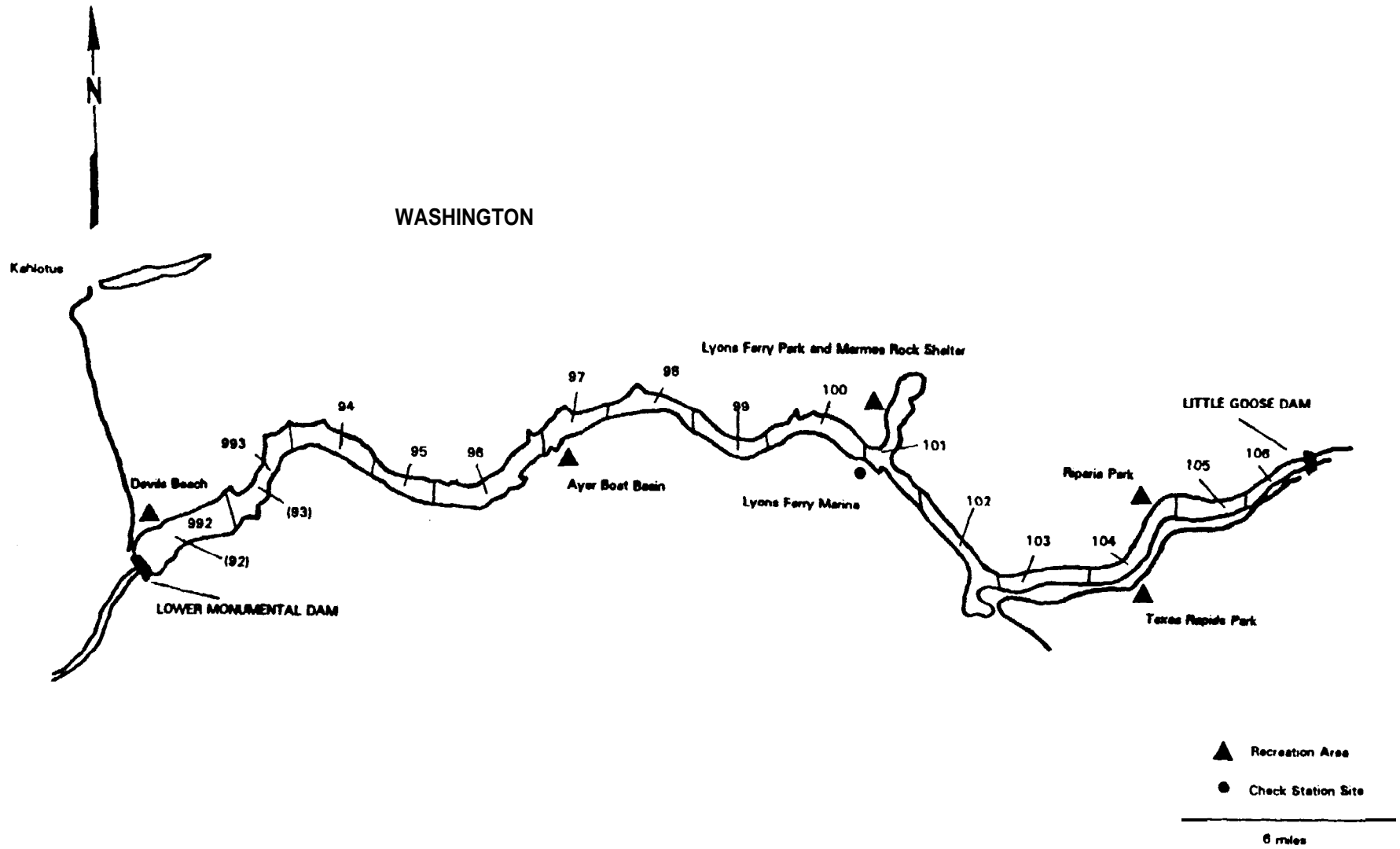

Figure C-8. Northern squawfish sport-reward fishery angler fishing location codes, Lower Monumental Dam to Little Goose Dam, 1991.

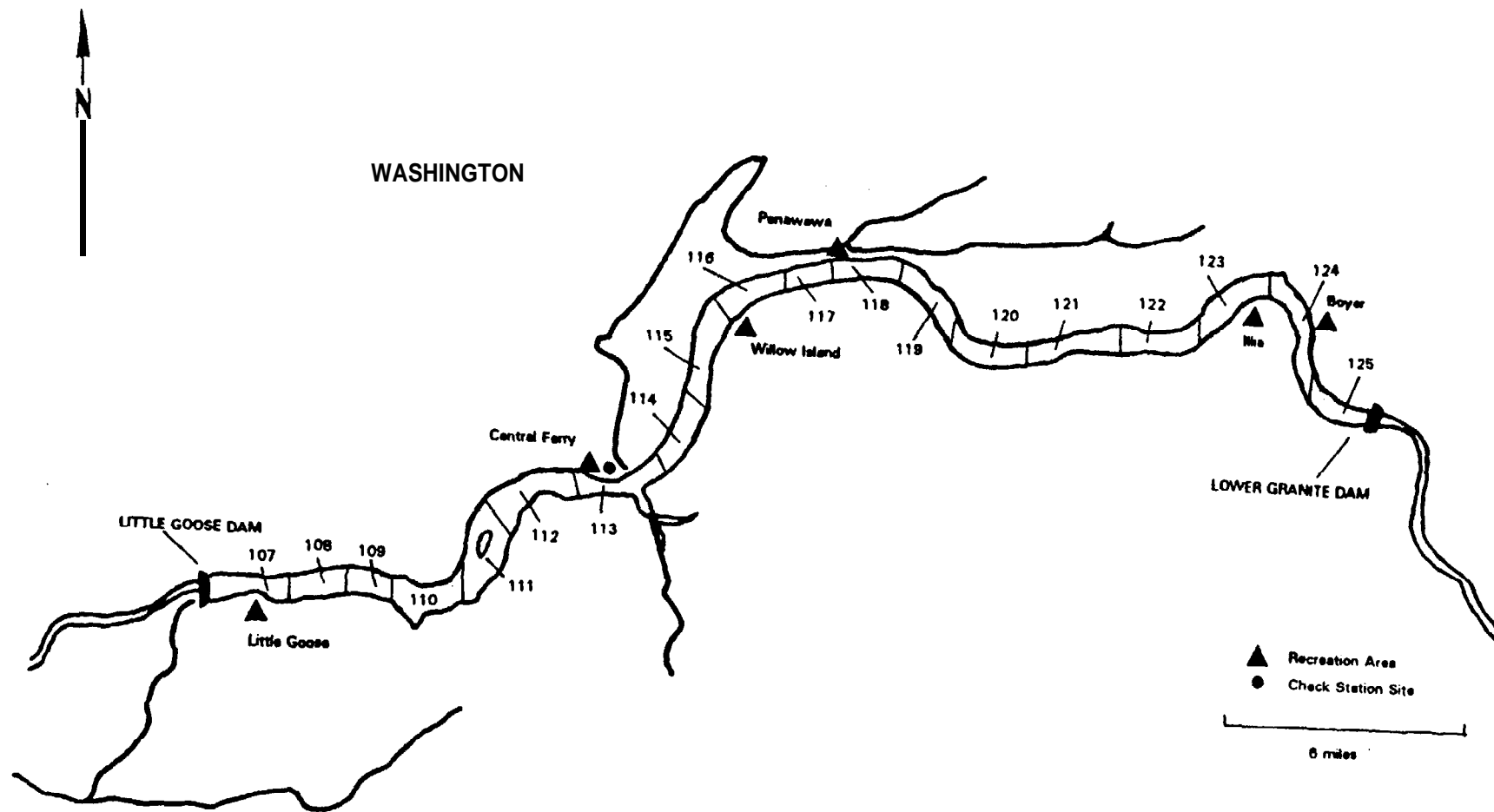

Figure C-9. Northern squawfish sport-reward fishery angler fishing location codes, Little Goose Dam to Lower Granite Dam, 1991.

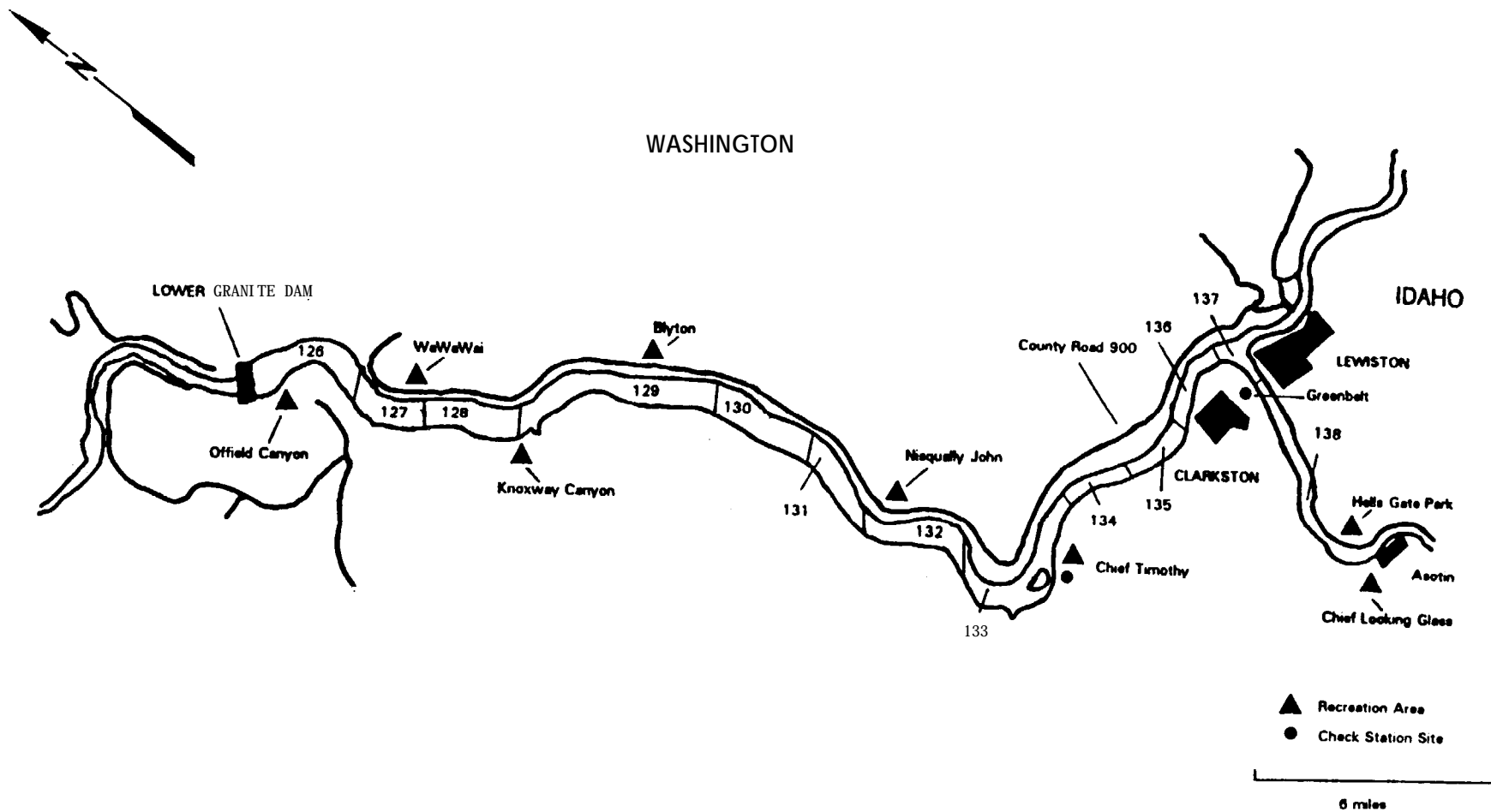

Figure C-10. Northern squawfish sport-reward fishery angler fishing location codes, Lower Granite Dam to Asotin, WA., 1991.



Appendix D. An example of the Angler Fish Data Base Form used during the creel survey during May 24-September 22, **1991**.









REPORT C

The Use of Controlled Angling to Manage Northern Squawfish  
Populations at Selected Dams on the  
Columbia and Snake Rivers

Prepared by

Roy E. Beaty, Blaine L. Parker, Ken Collis, and Kathy McRae  
Columbia River Inter-Tribal Fish Commission



## CONTENTS

	<u>Page</u>
ACKNOWLEDGEMENTS .....	<b>115</b>
ABSTRACT .....	116
INTRODUCTION. ....	117
METHODS AND MATERIALS .....	<b>119</b>
Design and Procedures .....	<b>119</b>
Data .....	122
Equipment .....	122
Angling Techniques .....	123
RESULTS .....	123
Catch Per Angler Hour .....	124
Columbia River Dams .....	124
Snake River Dams .....	124
Incidental Catch .....	127
Columbia River Dams .....	127
Snake River Dams .....	128
DISCUSSION .....	131
Catch Per Angler Hour .....	131
Patterns in CPAH .....	131
Columbia River Dams .....	132
Snake River Dams .....	132
Overview .....	133
Incidental Catch .....	135
RECOMMENDATIONS .....	136
REFERENCES .....	<b>139</b>
APPENDIX <b>C-1.</b> Lure and Bait Descriptions, and Tabular Data Regarding Angler Effectiveness and Incidental Catches .....	143
APPENDIX C-2. Using Volunteers in Dam Angling Fisheries.....	<b>159</b>
APPENDIX C-3. Private Firms Interested in Participating in Dam Angling Fisheries .....	163
APPENDIX C-4. Availability, Distribution, and Use of Some Natural Baits .....	165



## ACKNOWLEDGEMENTS

We are grateful for the assistance of Lisa Ganuelas in handling and summarizing data, preparing tables and figures. Troy Matheny assisted with pre-season preparations and implementation. We also thank the managers of the tribal fisheries programs with whom we contracted: Silas Whitman, Nez Perce Tribe (Lower Granite Dam); Gary James, Confederated Tribes of the Umatilla Indian Reservation (McNary Dam); and Lynn Hatcher and Steve Parker, Confederated Tribes and Bands of the Yakima Indian Nation (John Day Dam). And we extend our sincerest thanks to the many angling technicians, both tribal and non-tribal members, who did their jobs so well.

We also thank the employees of the U.S. Army Corps of Engineers who were invaluable in their cooperation and willingness to assist our crews: Jim Kuskie (Bonneville Dam), Jim Williams (The Dalles and John Day dams), Brad Eby (McNary Dam), Susan Shampine and Larry Walker (Ice Harbor and Lower Monumental dams), Rex Baxter and Ray Eakin (Little Goose Dam), and Jesse Smiley and Tim Wik (Lower Granite Dam). They were responsive to our needs and provided local perspectives on squawfish behavior.

We also thank Craig Burley, Washington Department of Wildlife, for providing office space for our Bonneville Dam crew, and the Oregon Department of Fish and Wildlife for sharing office space for our crew working at The Dalles Dam.

## ABSTRACT

Crews of anglers caught 39,817 northern squawfish *Ptychocheilus oregonensis* at eight U.S. Army Corps of Engineer Dams on the lower mainstems of the Columbia and Snake rivers. This effort was part of a predator control program to improve the survival of juvenile anadromous salmonids, particularly Snake River salmon *Oncorhynchus* sp. that are proposed for listing under the Endangered Species Act.

Seasonal average catch rates (catch per angler hour: CPAH) ranged from 0.7 (Ice Harbor Dam) to 3.1 (Bonneville Dam). Except for John Day Dam, Columbia River dams tended to have peak CPAH of > 6.0 in early July and another mode about a month later. On the Snake River, Little Goose and Lower Granite dams had relatively high CPAH (> 2.0) as early as May, and all dams had generally declining CPAH from June through August. Better bait probably caused the sharp increases in CPAH at Snake River dams at the end of August. We are investigating factors that may have influenced CPAH.

The catch of incidental species was closely monitored and controlled. Incidental species composed 7.87% of the total catch: salmonids (juveniles and adults, all species), 0.26%; sturgeon *Acipenser transmontanus*, 0.90%; bass *Micropterus* spp. 0.89%; catfish *Ictalurus* sp. and *Ameiurus* spp. 5.10% ; walleye *Stizostedion vitreum*, 0.07%; American shad *Alosa sapidissima* 0.19%; and all other species, 0.38%. All incidental species were released, most in good condition.

We recommend improvements in controlled angling fisheries, including data collection. Predaceous warmwater exotic species (85.4% of the incidentals caught) should be considered for control efforts. Options for involving volunteers in controlled angling fisheries and constraints on the use of some natural baits are presented in appendices.

## INTRODUCTION

The aquatic ecosystems of the Columbia and Snake rivers have been radically altered by human development, particularly by the construction of dams (NPPC 1986; Li et al. 1987). Dams and their reservoirs create habitat that is widely believed to favor indigenous and exotic predatory fishes (Jeppson 1957; Jeppson and Platts 1959; Li et al. 1987; NMFS 1991a, 1991b). Northern squawfish *Ptychocheilus oregonensis*, walleye *Stizostedion vitreum*, bass *Micropterus* spp., and catfish *Ictalurus* sp. are now abundant in the mainstems of the Columbia and Snake rivers, and their numbers may be increasing (Beamesderfer and Rieman 1991; NMFS 1991a, 1991b).

Dams and reservoirs have increased the vulnerability of juvenile salmonids *Oncorhynchus* sp. to these abundant predators. Except where artificially produced salmon are released (Thompson 1959; Meekin and Harris 1967), northern squawfish may not consume many juvenile salmonids in free-flowing reaches of larger streams in the Columbia Basin (Thompson 1959; Buchanan et al. 1981). However, most of the mainstem reaches of the Columbia and Snake rivers, in which juvenile anadromous salmonids rear and migrate, are now dammed and impounded. Dams kill, injure, and disorient the juvenile salmonids; reservoirs trap suspended sediments that could cloak the vulnerable prey and also prolong the exposure of the smolts to resident predators.

Millions of smolts fall prey to these predators. An average of 21% of adult ( $\geq 180$  mm) northern squawfish captured below Lower Granite Dam in 1976 (May-June) had salmonids in their guts (Sims et al. 1977). Uremovich et al. (1980) estimated that northern squawfish in the forebays of Bonneville spillway and first powerhouse consumed more than 2 million smolts from April through August in 1980. Employees of the National Marine Fisheries Service (NMFS, Lynette Hawkes, unpublished data) observed predation activity between 1600 and 2100 hours in one area of the forebay of Bonneville first powerhouse from 22 May through 20 August 1990, and estimated as many as 24,000 observable attacks occurred during the five-hour period on a single day (28 June). Predaceous fishes in John Day Reservoir in the mid-1980s may have consumed 2.7 million (simulated 95% CI 1.9 million - 3.3 million) juvenile salmonids each year, with northern squawfish accounting for most of the loss (Rieman et al. 1991). Approximately 21% of the loss in John Day Reservoir occurred in the boat-restricted zone, which extends 1 km below McNary Dam. Northern squawfish, smallmouth bass, and channel catfish are abundant and active predators on juvenile salmonids in reservoirs on the lower Snake River (Bennett et al. 1983; Bennett and Shrier 1986; Bennett et al. 1988). Predation by northern squawfish is commonly observed at many dams, particularly on the lower Columbia River, and juvenile salmonids are frequently recovered from the guts of squawfish taken from these areas.

Predation on juvenile salmonids in the mainstem may also be density compensatory (Uremovich et al. 1980; Beamesderfer et al. 1988; Vigg 1988), a condition that would exacerbate the continuing decline of anadromous salmonids in the Columbia River Basin. Snake River sockeye salmon *O. nerka* and chinook salmon *O. tshawytscha* have been proposed for listing as endangered and



threatened species, respectively, under the Endangered Species Act', and predation by squawfish and exotic warmwater fishes on migrating juveniles was identified as a factor in the declines of these species (NMFS 1991a, 1991b).

Determined efforts to control this predation are only just beginning. Northern squawfish populations and their diets in the mainstem Columbia and Snake rivers have been studied for over 30 years (e.g., Thompson 1959; Sims et al. 1976, 1977; Bennett et al. 1983; Poe and Rieman 1988). For example, Sims et al. (1977) caught and subsequently released 22,503 northern squawfish in the upper part of Lower Monumental Pool in 1976.

Attempts to control predation by northern squawfish on juvenile salmonids have been made in other areas. From 1935 to 1938, Foerster and Ricker (1938, 1941) removed over 10,000 squawfish (in addition to other predators) from Cultus Lake, British Columbia, and estimated an 88% reduction in the number of northern squawfish vulnerable to the size of gillnets used for capture. They estimated a > 3-fold increase in survival and improved growth of juvenile sockeye salmon from the predator control efforts.

Other studies have had some success in the control of northern squawfish populations, however, the effects of these removal efforts on system wide squawfish abundance and the survival of juvenile salmonids is unclear. Six seasons (1953-1958) of northern squawfish control in Hayden Lake (northern Idaho) removed approximately 10,900 kg of northern squawfish (Jeppson and Platts 1959). Indices of catch per unit effort (CPUE) for the two gillnet mesh sizes used declined 52% and 90% during that period. From 1958 through 1964 over 100,000 northern squawfish were removed by various methods from Lake Merwin (North Fork Lewis River, Washington) (Hamilton et al. 1970). However, efforts to measure a reduction in the abundance of northern squawfish produced ambiguous results, and there was no measurable increase in the survival of coho salmon O. kisutch.

Prior to 1990 there was apparently only one study to investigate methods to control northern squawfish in the mainstem Columbia River (LeMier and Mathews 1962). During this study -- which tested longlines, purse seines, and Merwin-style floating traps as harvest technologies -- over 17,000 northern squawfish were caught with two floating traps in two seasons, 1961 and 1962 (LeMier and Mathews 1962). Not until 1990 were control efforts resumed. In that year three limited fisheries (longlining, angling at dams, and sport reward angling) and a variety of other harvest methods were tested, yielding a total catch of about 20,000 northern squawfish (Vigg et al. 1990). Angling by agency technicians at five dams from May through late September harvested approximately 11,000 of the fish.

The Columbia River Inter-Tribal Fish Commission's (CRITFC) participation in the Predator Control Program (sponsored by the Bonneville Power Administration and Oregon Department of Fish and Wildlife) in 1991 was motivated by a strong desire to enhance the survival of juvenile anadromous salmonids in the Columbia River Basin by contributing to the expeditious development and implementation of predator control methods. Our primary objectives were to:

- <sup>1</sup> 56 Federal Register 14055, 5 April 1991 (sockeye)
- 56 Federal Register 29542, 27 June 1991 (spring/summer chinook)
- 56 Federal Register 29547, 27 June 1991 (fall chinook)

(1) remove northern squawfish at mainstem dams on the Columbia and Snake rivers using controlled angling fisheries, and (2) participate in cooperative efforts to evaluate and improve control techniques.

This report includes preliminary results, primarily catch rates of northern squawfish and incidental species by dam through the 1991 season. The results of lesser objectives, which concern staffing for angling crews and the use of some natural baits, are included in Appendices C-2, C-3, and C-4. More detailed analysis of the 1991 data is continuing, and those results will be included in a subsequent report.

## METHODS AND MATERIALS

### Design and Procedures

Crews angled at each of the eight U. S. Army Corps of Engineers (USACE) dams on the lower mainstems of the Columbia and Snake rivers (Figure C-1). Crew size and work season varied among dams (Table C-1).

The field season spanned 21 weeks, from May 5 to September 28, 1991. The weeks, which began on Sunday, can be grouped approximately by month:

<u>Weeks</u>	<u>Month (approx.)</u>
1-4	May
5-8	June
9-13	July
14-17	August
18-21	September

Daily and weekly work schedules varied and were usually established by each crew to correspond with periods when they could be most effective. However, the crews were sometimes instructed to fish during times that had not been recently fished (e. g., 2200-0400 hours) to monitor any changes in the productivity of those hours.

Anglers typically fished a variety of sites during each day, although most angling occurred at the most productive sites. Angling sites at each dam were delimited at the beginning of the season on the basis of whether they were above or below the dam (i. e., forebay or tailrace, respectively), which major structure of the dam they were associated with (e. g., powerhouse, navigation lock, shoreline, etc.), and their unique structural and water conditions. Generally, sites were delimited as broadly as possible without combining areas that were thought to produce catch rates that were consistently and greatly different. As with hours of the day, anglers were occasionally instructed to fish less productive areas so that we might document changes in productivity. Anglers often moved among sites to allow recruitment of northern squawfish into areas where fish had been recently removed.

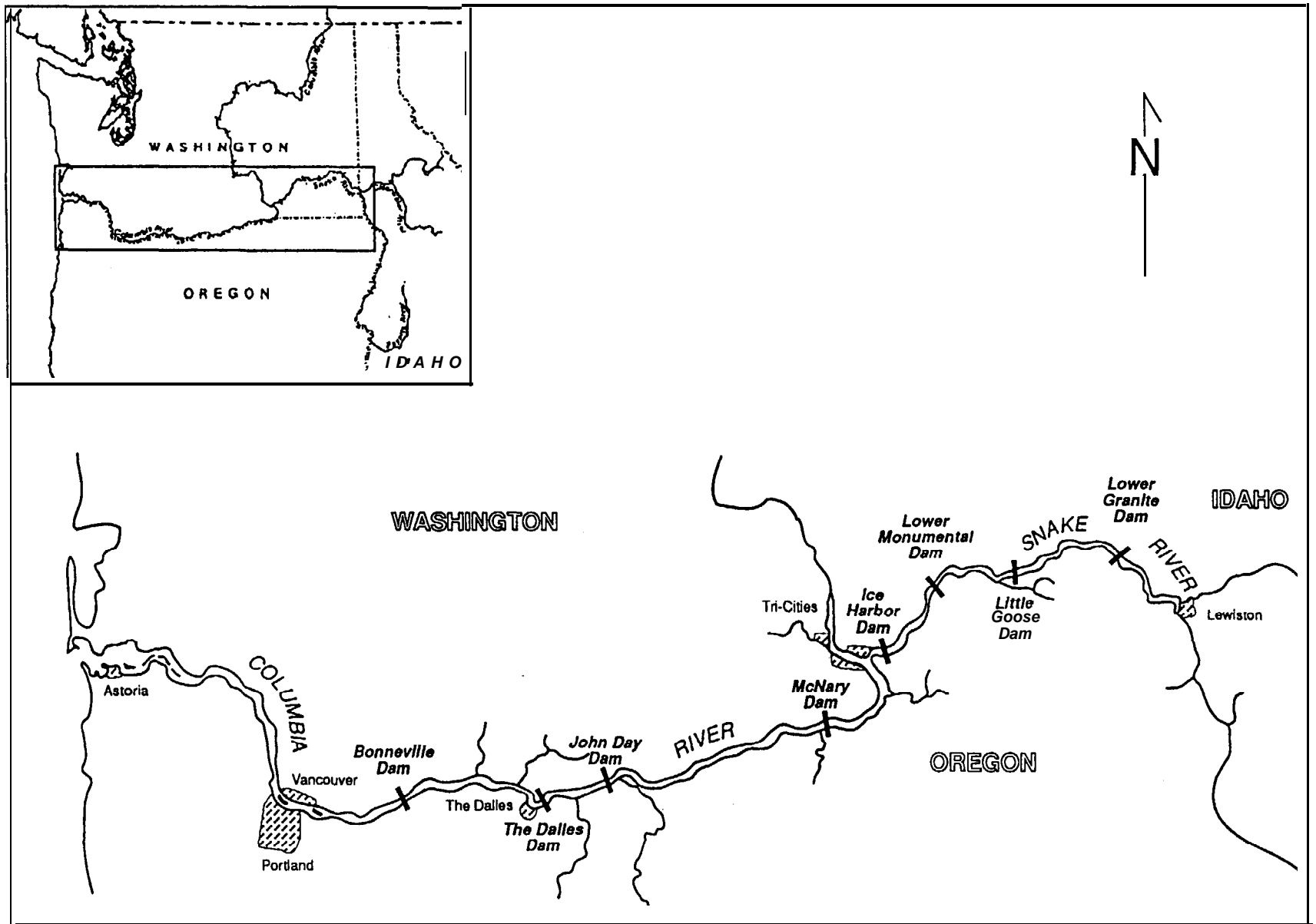

Figure C-1. Dams where controlled angling operations were conducted in 1991.

Table C-1. Synopsis of 1991 angling operations. Those fish included in total catch for which we lack complete data records are removed from subsequent CPAH calculations.

Dam (river km)	Maximum crew size	Season	Supervised by	Total catch of northern squawfish
<u>Columbia River</u>				
Bonneville (233)	8	May 15-Sept 6	CRITFC	8,188 <sup>a</sup>
The Dalles (310)	8	July 2-Sept 27	CRITFC	3,694 <sup>b</sup>
John Day (348)	5	May 23-Sept 27	YIN <sup>c</sup>	5,022 <sup>d</sup>
McNary (470)	8	May 16-Sept 27	CTUIR <sup>e</sup>	8,697 <sup>f</sup>
<u>Snake River</u>				
Ice Harbor (16)	4	May 9-Sept 23	CRITFC	1,486
Lower Monumental (68)	5	May 8-Sept 23	CRITFC	3,335 <sup>g</sup>
Little Goose (113)	5	May 7-Sept 20	CRITFC	4,915
Lower Granite (172)	5	May 6-Sept 26	NPT <sup>h</sup>	4,480
			Total	39,817

<sup>a</sup> Includes 57 fish for which minutes fished was not recorded.

<sup>b</sup> Includes 20 fish for which minutes fished was not recorded.

<sup>c</sup> Confederated Tribes and Bands of the Yakima Indian Nation

<sup>d</sup> Includes 18 fish for which minutes fished was not recorded.

<sup>e</sup> Confederated Tribes of the Umatilla Indian Reservation

<sup>f</sup> Includes 349 fish on 7/22 and 7/25 for which actual data records are not available.

<sup>g</sup> Includes 22 fish for which minutes fished was not recorded.

<sup>h</sup> Nez Perce Tribe

Anglers were encouraged to be innovative with baits and lures, particularly when catch rates were low. However, some baits and lures were used more frequently and will serve as standards for comparisons (see Appendix Table C-1.1 for list of baits and lures used).

To provide precise and accurate records of catch, effort, and conditions (e.g., bait and site), anglers were constrained to a single bait type and a single site during a period of time that could vary from 15 min to 2 h. One angler's effort during this period generated an "observation", which corresponded with one data record and often included more than one fish caught. Data items are described below. An observation could be terminated by either the crew supervisor, who usually recorded the data and transported the caught northern squawfish to storage, or by the angler. In the latter case the angler would make an interim record of the data from that observation. Only time spent angling and handling the gear (measured with a stop watch) is included in the measure of effort; other activities (e.g.,

breaks, transporting fish, recording data) are not. These methods differed from those used in 1990 (Vigg et al. 1990) in that 1991 observations were flexible in length, sites were larger, and the anglers generally decided where and when to fish depending on their productivity. Units for measuring effort (angler hour) are equivalent, however, so catch rates can be directly compared between years. We believe that angler effort for some observations in 1991 may be inflated slightly by the inclusion of some non-angling time.

#### Data

Data were collected for evaluating and improving the fishery without a *priori* knowledge regarding the importance of each factor. Some data (e.g., weather conditions) were recorded in log books. Other data (e.g., smolt passage indices, water temperature) will be obtained from other sources and used in subsequent analyses.

Data were collected on dam, date, time of day when observation ended, angler, site on dam, bait or lure, minutes fished, the number of northern squawfish caught, and the numbers and conditions of incidental species caught during each observation. From these data, catch per angler hour (CPAH) were calculated as the standard unit of comparison for angler success. Codes and definitions for all variables are included in documentation for the database.

We recorded catch of incidental species for which management plans have been adopted by the tribes and fishery management agencies (CRFMP 1988). These included bass, walleye, white sturgeon *Acipenser transmontanus*, catfish *Ameiurus* sp. and *Ictalurus* sp., American shad *Alosa sapidissima*, and several species of salmonids. All other species caught were listed as "others", and included peamouth *Mylocheilus caurinus*, chiselmouth *Acrocheilus alutaceus*, suckers *Catostomus* sp., and carp *Cyprinus carpio*. Salmonids were classified as juveniles or adults (separated approximately at 35 cm), but were not identified to species. We decided that the additional handling required to determine species, particularly for juveniles, would unduly harm the fish.

We also assigned each incidentally caught fish (except shad) to one of three classes based on their condition at release: (1) minimal injury, certain to survive; (2) moderate injury, may or may not survive; (3) dead, nearly dead, or certain to die. Fish in Condition 1 included those with little bleeding and that vigorously swam away when released. Fish that were hooked in vital areas (e.g., eye, stomach, gills) or bleeding heavily were included in Condition 3. Sturgeon that were lost or cut loose before landing were classified separately as lost fish, although they may be considered in Condition 1.

#### Equipment

Anglers used two general types of fishing tackle. The heavy "mechanized" outfit included "deep-sea" level wind reels (Penn Senator 114 6/0), trolling rods with roller guides designed for ocean sport fishing, and motors ("Electra-Mate" Model 600) that attached to the reels to decrease fatigue from reeling in many large fish. The motors were powered with 12-volt batteries of a size commonly used in golf carts. The lighter outfit included spinning and level wind reels and rods typically used for steelhead and game fish of

similar size. Many brands and models of the lighter equipment were used depending on availability, cost, method of fishing, and angler preferences.

Terminal gear (e.g., line, swivels, and hooks) had to endure lifting dozens of 1-3 kg fish many meters above the water. Monofilament line had to be easy to cast, yet strong and abrasion resistant. Line light enough to allow larger incidental species to break free was used, even though it caused us to lose some large northern squawfish.

Angling crews used a variety of hard lures (e.g., spoons, spinners, and plugs) and soft lures (mostly of flexible plastic) (see Appendix Table **C-1.1**). Of the many different soft lures available, we used mostly grubs, twin-tailed grubs, and those with fish-shaped bodies. Soft lures were used with a weighed jig hook positioned in the lure body. We also designed and used an experimental lure constructed of nylon parachute cord that was affixed to a weighted jig hook.

We used a variety of natural baits, such as, fresh dead smolts, live grasshoppers, and regurgitated juvenile lampreys (see Appendix Table **C-1.1** for list). Obtaining, preserving, and distributing good natural baits was often difficult (Appendix C-4). Combinations of artificial lures and natural baits on the same hook were often effective.

#### Angling Techniques

Mechanical outfits, which were not used extensively, were best suited for areas where the current flowed away from dam structures, such as off of the tailrace decks and navigation locks. The most practical technique was to allow the current to pull the weight (170-230 g) away from dam until the bait reached the desired area of water. When a fish was hooked the angler switched on the reel and brought in the fish.

Anglers fished from the dams and the nearby shoreline. In the tailraces, lures and baits were generally drifted (at various depths to 8 m) away from the project. Bait was fished either similarly to lures or stationary on the bottom. Fishing in the forebays usually required active casting and prompt retrieval to reduce the loss of terminal tackle on submerged logs, trash racks, and cables.

#### RESULTS

A total of 39,817 northern squawfish were caught at all dams (see Table C-1; detailed results are in Appendix **C-1**). The data have been summarized sufficiently to report angler success (CPAH) by dam and week and to report incidental catch. Analysis of factors that influence CPAH is ongoing. Field data are not available for some days at McNary Dam, however, we had oral communication of the catch of northern squawfish on those days. The results presented here are organized by river (Columbia and Snake) and reported for each dam.

## Catch Per Angler Hour

### Columbia River Dams

Bonneville Anglers fished 2,621.4 h and caught 8,131 northern squawfish for a seasonal average CPAH of 3.1 (Appendix Table C-1.2). Weekly average CPAH increased rapidly from less than 1.0 during the first two weeks to a peak of 6.6 in week 10 (July 7-13). Excepting a small peak in week 15 (August 11-17), the decline was similarly rapid (Figure C-2). Although the regular Bonneville crew ceased fishing in week 18, another crew was occasionally sent to Bonneville through week 21 to monitor possible changes. Catches during this period were low (CPAH of 0.3). Catch per angler hour remained above 1.0 for 14 (74%) of the 19 weeks fished (Appendix Table C-1.2).

The Dalles Angling started in July and ended in September. Anglers fished 1,333.0 h and caught 3,674 northern squawfish for an average CPAH of 2.8 (Appendix Table C-1.3). Weekly average CPAH values increased rapidly from 1.6 to 6.5 in the first three weeks (9-11), then declined to 1.4 two weeks later (Figure C-2). Weekly averages were  $\geq 1.0$  for 13 of 13 (100%) weeks fished (Appendix Table C-1.3). A peak in catch was observed in the second week of September and then declined to 1.9 and 1.2 CPAH the last two weeks respectively (Figure C-2).

John Day The crew fished 2,816.5 h and caught 5,004 northern squawfish for a seasonal CPAH of 1.8 (Appendix Table C-1.4). John Day Dam CPAH data are atypical compared with trends observed at other Lower Columbia River dams. John Day lacked a distinct peak in CPAH until week 14 (August 4-10) unlike Bonneville and The Dalles dams, which had their peaks one month earlier (Figure C-2). No trends in CPAH were apparent in May and June, when values ranged between 0.0 and 2.1. Average CPAH was above 1.0 in 15 (79%) of 19 weeks (Appendix Table C-1.4).

McNary Anglers at McNary Dam caught 8,348 northern squawfish in 3,416.1 h for a mean CPAH of 2.4 (Appendix Table C-1.5). Patterns in CPAH at McNary Dam roughly resembled those at Bonneville Dam. The highest weekly CPAH (7.3) occurred in week 13 (July 28-Aug 3) when 1,654 northern squawfish were caught. This was the highest CPAH of the season for all projects. Catch rates declined very sharply from week 13 to week 15 and, except for week 19, remained below 1.0 after week 15 (Figure C-2). Of the 20 weeks fished, CPAH values exceeded 1.0 in 12 (60%) of them (Appendix Table C-1.5). Including the 349 fish for which we lack complete data records, 8,697 northern squawfish were caught at McNary Dam, more than at any other dam (see Table C-1).

### Snake River Dams

Ice Harbor Anglers worked 21 weeks, fished 2,052.6 h, and caught 1,486 northern squawfish for a seasonal CPAH of 0.7 (Appendix Table C-1.6). This project was unique from the perspective that the peak in CPAH (week 7, late June) was only slightly greater than the seasonal average (Figure C-3). Weekly CPAH values increased again in late August. Only 7 (33%) of the 21 weekly CPAH values were at or above 1.0 (Appendix Table C-1.6).

Lower Monumental The crew had a seasonal CPAH of 1.3, catching 3,313 northern squawfish in 2,471.7 h (Appendix Table C-1.7). Angling efficiency

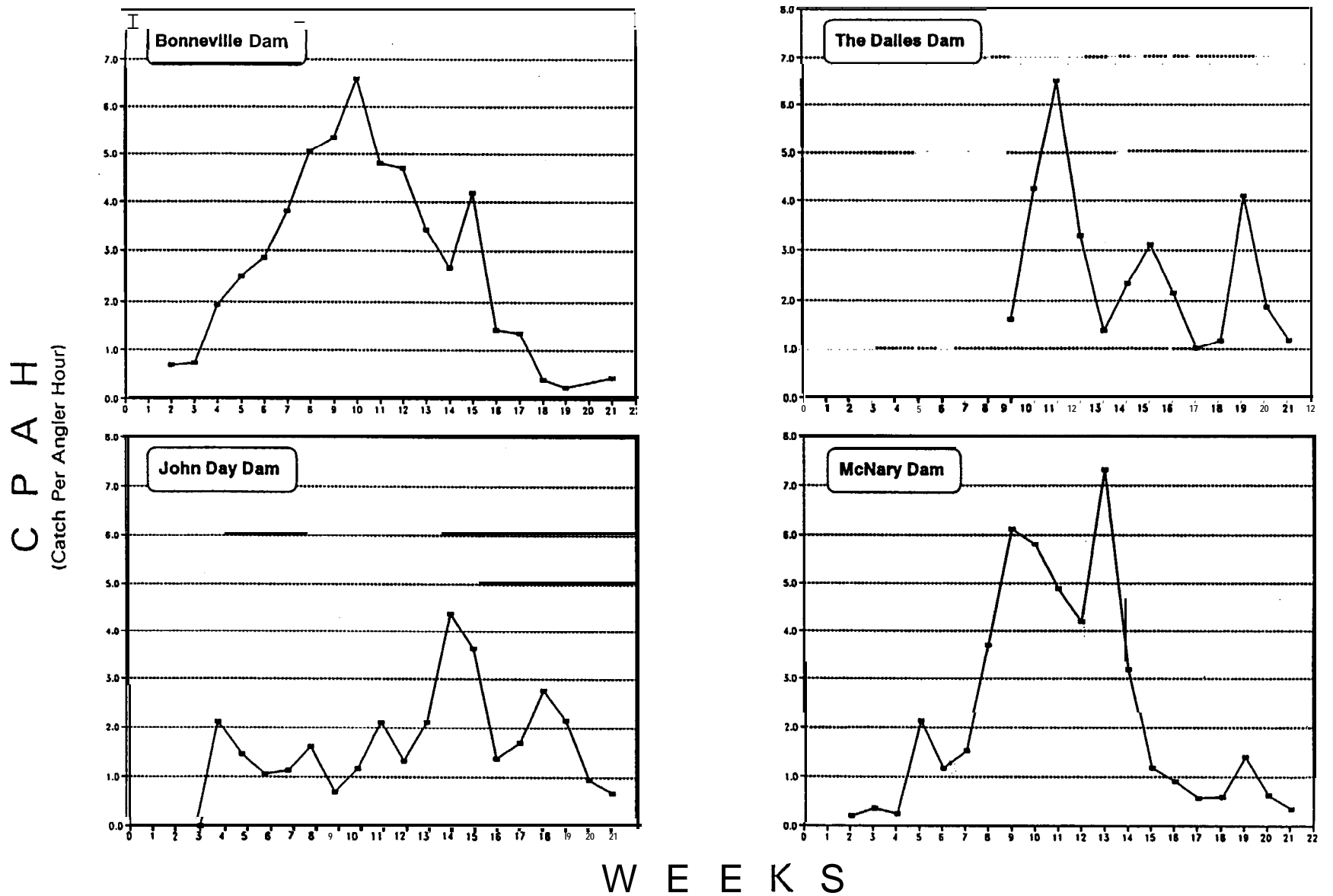

Weeks 1-4: May 5-June 1    Weeks 5-8: June 2-29    Weeks 9-13: June 30-Aug 3    Weeks 14-17: Aug 4-31    Weeks 18-21: Sept 1-28

Figure C-2. Catch per angler hour (CPAH) in 1991 by week for Columbia River dams.



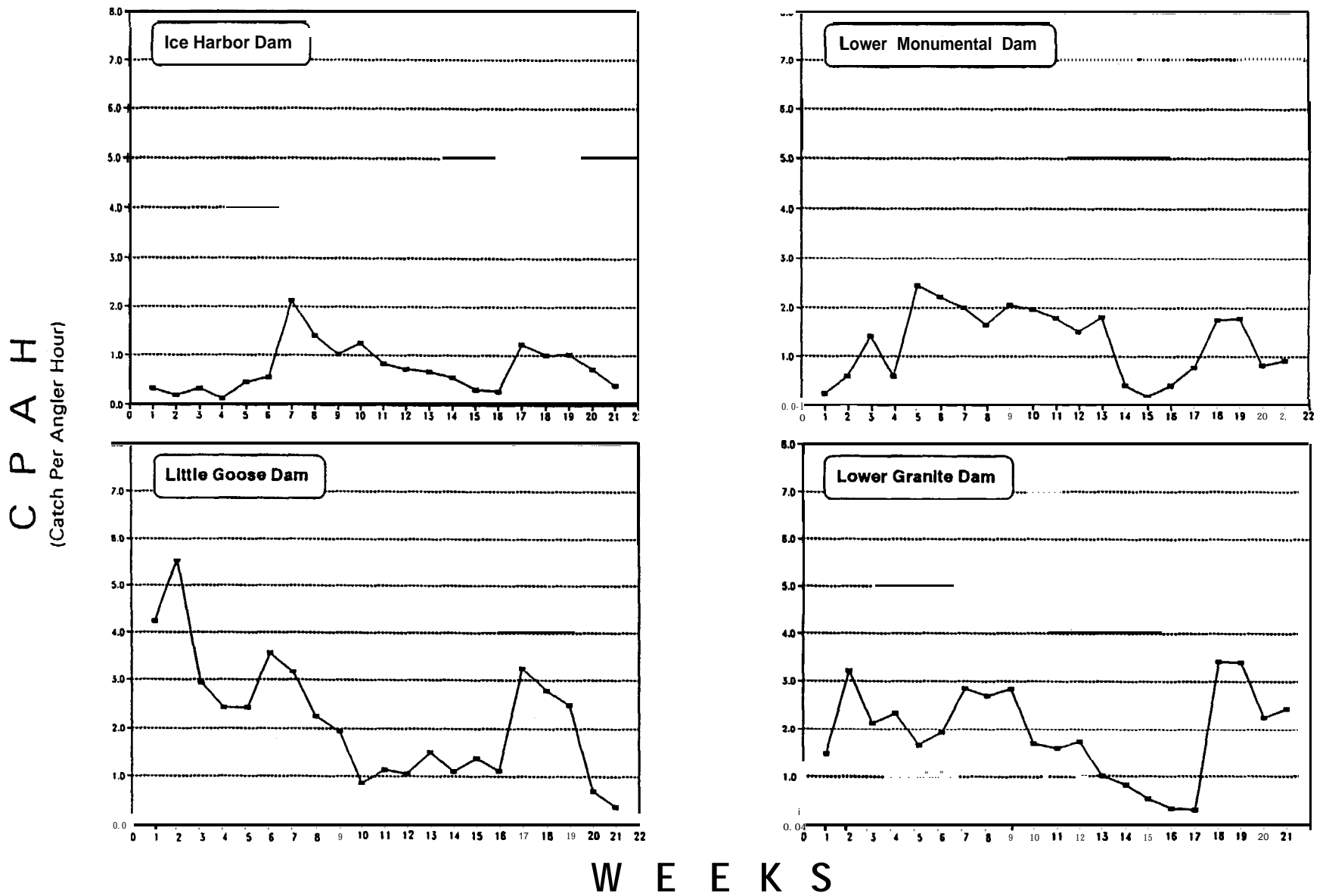

Weeks 1-4: May 5-June 1    Weeks 5-8: June 2-29    Weeks 9-13: June 30-Aug 3    Weeks 14-17: Aug 4-31    Weeks 18-21: Sept 1-28

Figure C-3. Catch per angler hour (CPAH) in 1991 by week for Snake River dams.

peaked during week 5 (June 2-8), two weeks prior to the season high at Ice Harbor Dam. Unlike Ice Harbor Dam, weekly CPAH values remained relatively consistent from week 5 through week 13 (June 2 to Aug. 3) (Figure C-3). Catch per angler hour slumped in weeks 14-17 (August 4-31), but subsequently climbed back to above 1.0 for two weeks. Seasonally, 57% (12 of 21) of the weekly CPAH values exceeded 1.0 (Appendix Table C-1.7).

Little Goose Anglers fished 2,137.9 h and caught 4,915 northern squawfish for a seasonal CPAH of 2.3 (Appendix Table C-1.8), the highest seasonal CPAH value for the four Snakes River dams. The highest weekly catch and associated CPAH value were early, in week 2 (May 12-18). Thereafter, CPAH generally declined until week 17 (late August) when anglers began using grasshoppers for bait and CPAH rose dramatically (CPAH of 3.3) (Figure C-3). Weekly CPAH values were above 1.0 in 18 (86%) of the 21 weeks (Appendix Table C-1.8), more than any of the other Snake River dams.

Lower Granite In 21 weeks, anglers fished 2,448.1 h and caught 4,480 northern squawfish for a mean CPAH of 1.8 (Appendix Table C-1.9). The highest weekly CPAH occurred during weeks 18 and 19 (September 1-14, when grasshoppers were used as bait) rather than in May, as recorded for the Little Goose crew (Figure C-3). Weekly CPAH values were  $\geq 1.0$  in 81% (17 of 21) of the weeks (Appendix Table C-1.9).

#### Incidental Catch

##### Columbia River Dams

Bonneville Incidentally caught species composed of only 0.70% of the total catch (Figure C-4), the lowest proportion at any Columbia River dam (Appendix Tables C-1.10 and C-1.11). Of the 11 salmonids caught (19.0% of the incidental catch), none were released in Condition 3 (Appendix Table C-1.10). Six sturgeon were hooked at Bonneville Dam, although three were hooked and lost or cut loose. Slightly less than half of the incidental catch was shad (Appendix Table C-1.10). Only seven bass and no walleye or catfish were caught. Fishes other than salmonids and sturgeon were 70.7% of the incidental catch (Appendix Table C-1.10).

The Dalles This crew caught a greater percentage (5.04%) of incidental fish than the crew at Bonneville Dam (Figure C-4). Bass comprised of 79.1% (155) of this catch, which is 77.1% of the total bass catch for the Columbia River dams (Appendix Table C-1.10). One juvenile salmonid (0.03% of total catch) constituted the entire salmonid catch for the season, and eighteen sturgeon (0.46% of total catch) were hooked and released (Appendix Tables C-1.10 and C-1.11). Exotic fishes (i.e., bass, catfish, walleye, and shad) and species classified as "Other" were 90.3% of the incidental catch (Appendix Table C-1.10).

John Day Incidentally caught species were 3.65% of the total catch (Figure C-4). Seven salmonids (all adults) were caught, and all were released in Condition 1. Sturgeon were the most numerous incidental catch, with 48 landed; 10 additional fish were hooked, but lost or cut loose. The 15 walleye caught here were almost half of the 31 caught at all dams (Appendix Table C-1.10). Walleye and all other exotic species and fish classed as "Other"

composed 65.8% of the incidental catch and 2.40% of the total catch (Appendix Tables C-1.10 and C-1.11).

McNary Of the total catch, 6.56% were incidentals, the highest percentage of any Columbia River dam (Figure C-4 and Appendix Table C-1.11). Adult and juvenile salmonids composed just 2.29% of the incidental catch, which was dominated by catfish and sturgeon, 48.3% and 38.3%, respectively. Exotic species (including catfish) and those classified as "Other" accounted for 59.4% of the incidental catch (Appendix Table C-1.10)

#### Snake River Dams

Ice Harbor Incidentally caught fish comprised of 38.3% of the total catch (Figure C-5), the highest proportion at any Snake River dam (Appendix Tables C-1.12 and C-1.13). Exotic or "Other" species composed of 93.3% of incidental species caught (Appendix Table C-1.12). The proportion of salmonids was about 0.12% of the total catch (Appendix Table C-1.13). Catfish (808) were 33.5% of all fish caught and dominated (87.4%) the incidental catch. Sturgeon and bass were a minor component of the incidental catch, .6.38% and 3.35% respectively, and only a few shad and other species were caught (Appendix Table C-1.12). The proportion of incidental species caught decreased dramatically in September (Appendix Table C-1.13).

Lower Monumental The total catch consisted of 19.7% incidental species (figure C-5). The salmonid catch consisted mostly of juveniles (77.1%) (Appendix Table C-1.12). Catfish and bass were the largest components of the incidental catch with 83.3% and 9.24% respectively. Three sturgeon were caught at this project. Exotic and "Other" species composed 95.3% of the incidental catch (Appendix Table C-1.12).

Little Goose Three hundred twenty-nine fish of incidental species, 6.27% of the total catch (Appendix Table C-1.13), were caught while fishing for northern squawfish at Little Goose Dam, a substantial decrease from the proportions of incidentally caught fish at Ice Harbor and Lower Monumental dams (Figure C-5). Of the 28 salmonids caught at this dam, most (82.1%) were juveniles (Appendix Table C-1.12). Catfish were 63.5% of the incidentals caught, and 91.2% of the incidental catch was exotic species (including catfish) or classified as "Other" (Appendix Table C-1.12).

Lower Granite The number of incidentally caught fish (276) at Lower Granite was the lowest of the Snake River dams (Appendix Table C-1.12), as was the proportion of incidental species in the total catch (5.80%) (Figure C-5 and Appendix Table C-1.13). Catfish comprised 66.7% of the incidental catch, 93.5% of which were exotic (including catfish) and "Other" species. Salmonids (0.27% of total) were nearly all (84.6%) juveniles (Appendix Table C-1.12). The catch of bass was second only to catfish, a trend repeated at other Snake River dams. Catches of all other species were nil or negligible (Appendix Tables C-1.12 and C-1.13).

Bonneville Dam

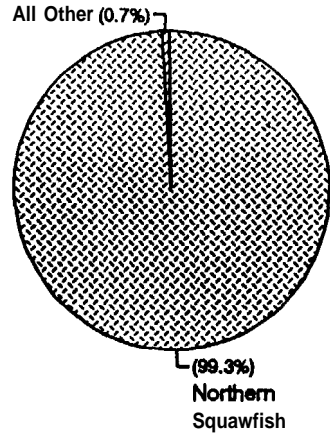

The Dalles Dam

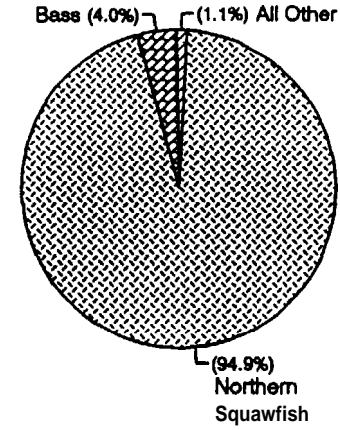

John Day Dam

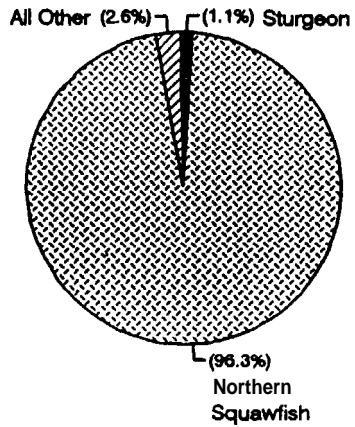

McNary Dam

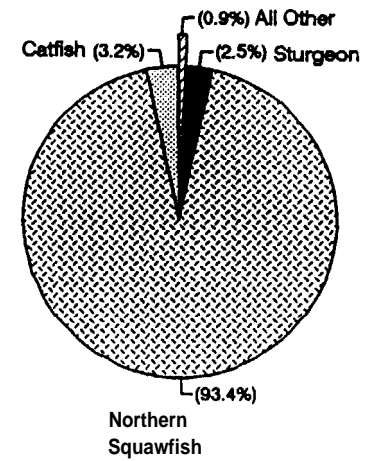
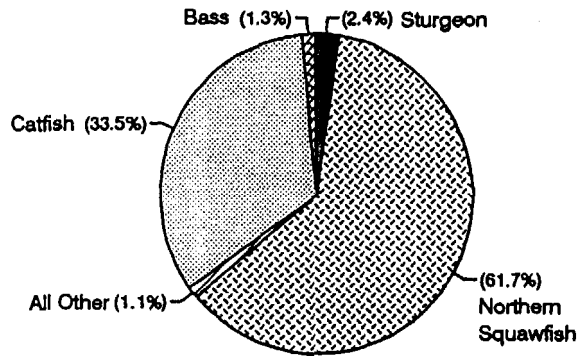
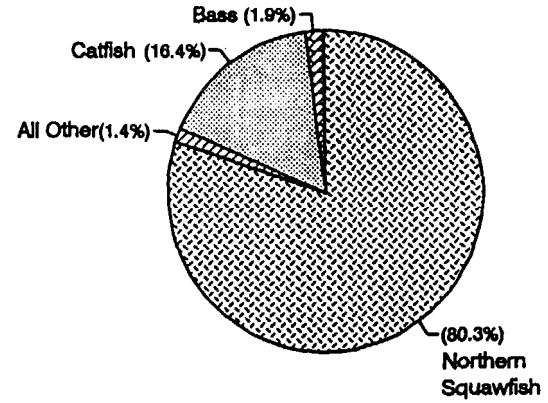

Figure C-4. Total catch proportions for Columbia River dams in 1991. Species proportions are displayed when they constituted more than 1 percent of total catch.

Ice Harbor Dam



Lower Monumental Dam



Little Goose Dam

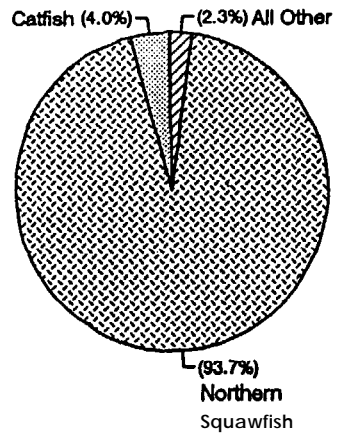

Lower Granite Dam

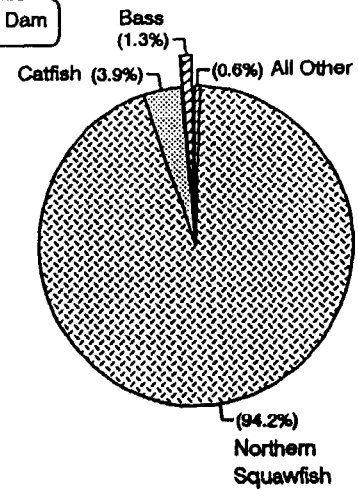

Figure C-5. Total catch proportions for Snake River dams in 1991. Species proportions are displayed when they constituted more than 1 percent of total catch.

## DISCUSSION

Anglers at the eight dams removed 39,817 northern squawfish in 1991, although several thousand of these fish were marked and returned alive to the rivers. All of these fish were caught within casting distance of the dam or shorelines adjacent to the dams, which comprises a very small area. Also, most came from tailrace areas, where predation rates are high (Rieman et al. 1991). Our primary objective was to remove northern squawfish, but we also closely monitored and controlled the fishery to minimize adverse impacts on other species, particularly Snake River salmon. Some baits, sites, and times of day were abandoned when they produced undesirable catches of incidental species. The summaries of CPAH and incidental catch that are presently available are sufficient to support some conclusions and recommendations about the fishery.

### Catch per Angler Hour

Average CPAH values are composite estimates of angler success, and differences among dams or weeks are caused by variability in squawfish abundance, as well as many other factors. For example, obtaining access to a new and productive site will cause a dramatic increase in average CPAH, as will discovery of an effective bait. We suspect that flow quantity, dam operations (e.g., spill, turbine operations), the number of smolts passing a dam, water temperature and turbidity, other activities in the area (e.g., electro-fishing), and spawning behavior of the northern squawfish also influenced our success. Ongoing analysis may enable us to describe some relationships between these factors and catch rates. Work conditions (e.g., weather), number of weeks already fished, and catch rates themselves may also influence the motivation and success of the anglers.

In 1990, ODFW anglers fished at five of the eight dams fished in 1991 (Vigg et al. 1990). Comparisons between years showed that seasonal CPAH values were higher in 1991 at three out of five dams (Table C-Z). Anglers in 1991, who were encouraged to target the most productive areas, were less constrained by their method of operation than anglers in 1990. Therefore we expected higher average CPAH for all five dams in 1991. Physical conditions may have differed between years, and anglers in 1991 may not have excluded all time spent on fish handling and other non-angling activities from their measures of effort. Continual fishing pressure this year, removals in previous years, and differences in angling seasons also may have influenced angler success in 1991, particularly at McNary Dam.

### Patterns in CPAH

We attribute the nearly universal (Ice Harbor Dam excepted) increase from the first to the second week of angling at each dam to learning (Figures C-2 and C-3). The initial days were usually spent exploring sites, learning how best to use the gear, trying different baits, etc. On the few occasions when we had a crew fish at another dam, the visiting crew was never as productive as the crew that was experienced at that dam. Generally, conditions at each dam were unique, and angling strategies had to be developed for each site and modified as conditions changed during the season. There are, however, some patterns in CPAH that are common and/or that might be explainable with information that we presently have.

Table C-2. Comparison of seasonal average CPAH between 1990 and 1991. Data from Vigg et al. (1990, Table 5) and Appendix Tables c-1.2 to c-1.9.

Dam	CPAH	
	1990	1991
Bonneville	1.4	3.1
The Dalles	1.1	2.8
John Day	1.3	1.8
McNary	3.4	2.4
Ice Harbor	1.3	0.7
Lower Monumental ( <i>not fished in 1990</i> )		1.3
Little Goose ( <i>not fished in 1990</i> )		2.3
Lower Granite ( <i>not fished in 1990</i> )		1.8

#### Columbia River Dams

All dams except John Day had a peak in CPAH in early to mid-July (weeks 9-11), followed about a month (4 weeks) later by a second mode (Figure C-2). The second mode (including a peak at John Day Dam occurred earlier at the upstream dams: McNary (week 13), John Day (week 14), and The Dalles and Bonneville (week 15). Further analysis may reveal a possible cause, such as passage of subyearling chinook migrants, that corresponds with the later peak. We presently have no explanation for the absence of a large peak at John Day Dam in July.

The pattern in CPAH for The Dalles Dam is not very revealing. A late start, delays in obtaining access to the productive area beside the sluiceway outfall, and the appearance of three distinct peaks in CPAH, make it difficult to draw conclusions about which weeks might be most productive in subsequent years.

In general, June through mid-August (weeks 5-15) was the most productive period for dam angling on the lower Columbia, particularly at Bonneville and McNary. John Day is an enigma; the best catch rates there were during August and early September (weeks 14-19). We did not observe an anticipated upswing during September at any of the dams to suggest that the migration of juvenile shad improves the success of dam angling. Patterns in CPAH observed this year may have been influenced by this year's unusually late, cool spring.

#### Snake River Dams

Dams on the Snake River did not have the mid-summer peak in CPAH that was common on the Columbia River (Figure C-3). Lower Granite and Little Goose had patterns of CPAH that were very similar to each other, including high catch rates in May (weeks 1-4). All dams on the Snake River experienced decreases during week 3 (upper two dams) or week 4 (lower two dams) when a very turbid spate moved downstream. The increase in week 6 (second week in June) at

Little Goose Dam resulted from finding and targeting an area where squawfish were concentrated, perhaps for spawning. Similar peaks at the other dams cannot be explained at present, but may be related to reduced flows and/or changes in spill. A general decline at all dams from about weeks 5-7 (early to mid-June) to weeks 15-17 (mid- to late August) may result from many factors, including rising water temperatures, reduced abundance of prey passing the dams, and waning angler enthusiasm. Squawfish may also migrate out of the tailrace areas after spring (Bennett et al. 1983) and therefore would not be available to anglers on the dams.

Late-season increases in CPAH at Little Goose Dam (week 17, end of August), Lower Granite Dam (week 18), and Lower Monumental Dam (week 18) can be attributed to switching to a new bait: grasshoppers. A similar increase at Ice Harbor Dam (week 17) corresponded with the use of better salmonid bait.

Catch rates at Ice Harbor Dam were very low through most of the season, yet a total of 1,486 northern squawfish were still caught there. Because of the low catch rates, less effort (fewer anglers on the crew) was invested at Ice Harbor Dam. The criteria and standards for evaluating the effectiveness and efficiency of the fisheries are not yet available to justify abandoning angling at this dam, however.

#### Overview

Generally, we wish to distribute effort among the dams to achieve the greatest effectiveness and efficiency. As can be expected, angler success (CPAH) varies considerably between dams and through time, and much of that variability cannot be foreseen. Nor can effort always be shifted readily.

In 1991 we assigned a crew of five anglers to each dam, except at Bonneville, The Dalles, and McNary dams, where special conditions existed. For example! Bonneville and McNary dams had the highest CPAH in 1990 of the five dams fished that year (Table C-Z). In 1991, eight anglers were assigned to Bonneville Dam at the beginning of the season; the McNary crew increased from five to eight technicians for June through August (weeks 5-17), when catch rates were expected to be high. Both of those strategies appeared to be fruitful (Table C-2), although further shaping seems warranted (e.g., limiting the Bonneville season to June-August). At The Dalles we sought to target the summer months and use seasonally available labor and perhaps volunteers to supplement the resident crews effort's (Appendix C-2). Delays caused by efforts to obtain access to the sluiceway outfall area interfered with this strategy, although the seasonal (through August) average CPAH was still comparatively high (Table C-2). In 1991 we were not able to respond quickly enough to seasonal changes in CPAH to make short-term (i.e., over one to four weeks) changes in our staffing level. Indeed, delays in obtaining catch and effort data precluded close monitoring of short-term changes in CPAH.

Generally, CPAH was highest in May (weeks 1-5) at Little Goose and Lower Granite dams on the Snake, from June through mid-August (approximately weeks 6-15) at Columbia River dams, and from mid-August through September (weeks 16-22) again on the Snake River. However, CPAH at John Day Dam was also high in September. With better methods to monitor CPAH and more flexible effort, we should be able to shift effort to match short-term changes in productivity (see RECOMMENDATIONS, below).



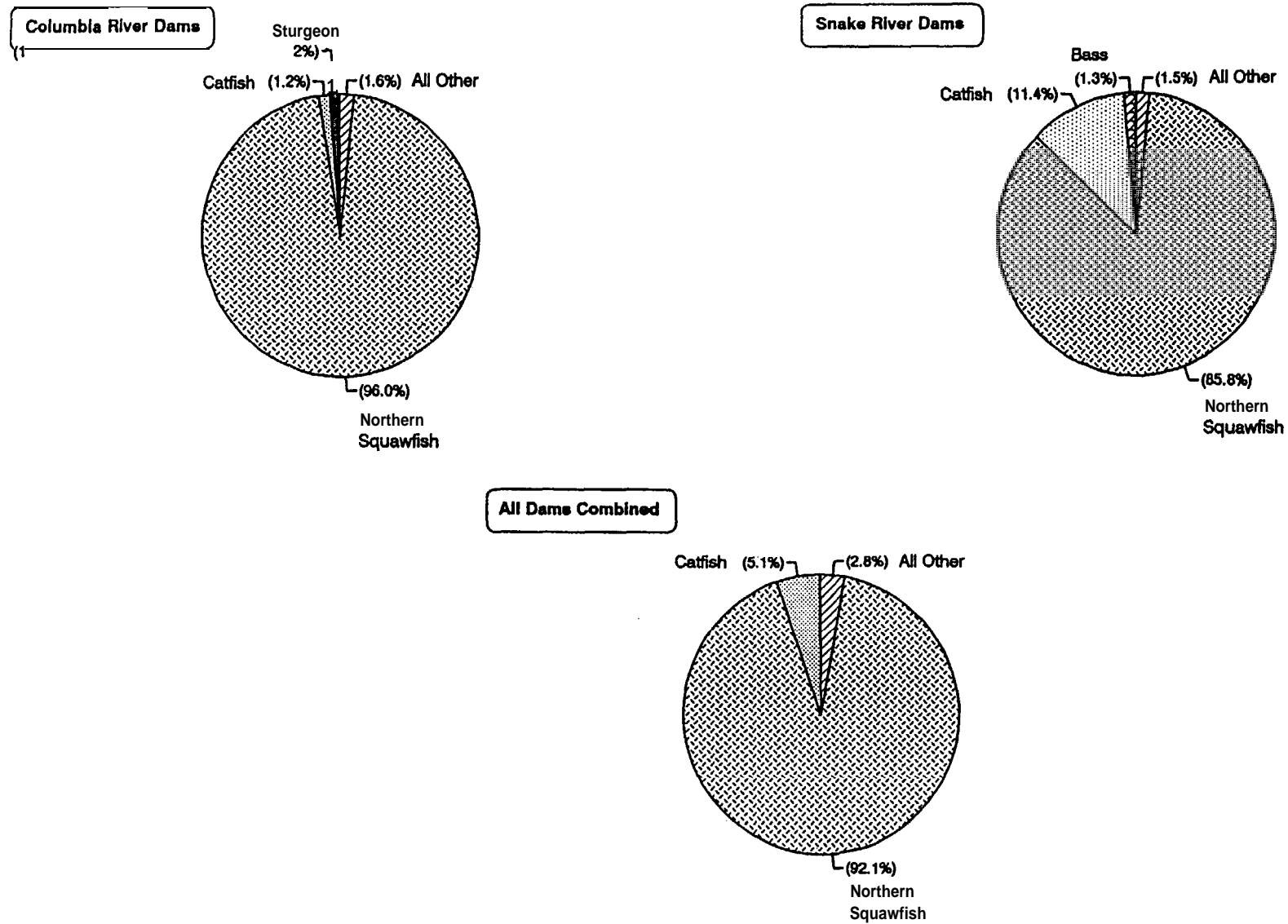

Figure C-6. Total catch proportions for Columbia River dams, Snake River dams, and all dams combined. Species proportions are displayed when they constituted more than 1 percent of total catch.

## Incidental Catch

Dam angling and other controlled removal fisheries can closely monitor and, if needed, limit impacts on incidental species. Having such control over removal fisheries is mandatory when and where critical species and stocks may be affected. Snake River sockeye and chinook salmon are certainly among those stocks, but it is unclear how exotic warmwater fishes should be classified, since they also prey on the salmonids that we must protect and restore (Bennett et al. 1983; Bennett and Shrier 1986; Bennett et al. 1988; Poe et al. 1991; Rieman et al. 1991). We know from our work this year that angling in public and non-public areas on the Snake River impacts those salmonids.

Numbers of incidentals caught does not adequately describe the impacts, because various methods of capture and handling cause varying degrees of stress and/or injury. We attempted to describe the condition of the fish as precisely as possible given the uncertainty regarding the fate of fish that were injured but released alive. The three condition classes used are as precise as we can be about whether the ultimate fitness of a fish was effected by our activities.

We did not attempt to identify salmonids by species. We did not believe that the additional information would justify the increased handling that could be required to discriminate species, particularly in juveniles.

For all dams combined, 3,401 (7.87%) of our total catch were incidental species (Figure C-6, Appendix Tables C-1.14 and C-1.15). Because of data that are not available for McNary dam, the total number, but not necessarily the proportion of incidentals, may be slightly greater than the total reported here. There were large differences between dams, with incidentals ranging from 0.70% of the total catch at Bonneville Dam to 38.3% at Ice Harbor Dam (Figures C-3 through C-5, Appendix Tables C-1.11 and C-1.13). Generally, the percent of incidental species (relative to Ice Harbor Dam) decreased at dams farther upstream on the Snake River and farther downstream on the Columbia River. Catfish comprised fully one-third of the total catch at Ice Harbor Dam, where anglers were most successful catching northern squawfish near the river bottom in the tailrace. The incidental catch at Snake River dams was dominated by catfish (80.2% of incidentals).

Our paramount concern with incidentals is the impact on salmonids. Salmonids (total of 73 juveniles and 39 adults, all conditions; see Appendix Tables C-1.14 and C-1.15) were less than 1% of the total catch at each dam, ranging from 0.03% at The Dalles to 0.84% at Lower Monumental Dam (Appendix Tables C-1.11 and C-1.13). Crews at Snake River dams caught 84.9% of the juvenile salmonids and 43.6% of the adults. Only four (5.48%) of the juvenile and one (2.56%) of the adult salmonids caught were certain to have died from their injuries (Condition 3); another 7 (9.59%) of the juveniles may have died (Condition 2) (Appendix Tables C-1.10 and C-1.12). Generally, salmonids appear to have composed greater percentages of the catch early and late in the season. Overall, the impact of 1991 dam angling on salmonids appears to be very small.

Impacts on other species also appear to be slight. Sturgeon contributed < 1% of the total catch at most dams, except for McNary (2.51%), Ice Harbor (2.45%), and John Day (1.11%) dams. Sturgeon overall were only 0.90% of the

total catch, and only 13 of 295 (4.41%) landed may have died or did die (Conditions 2 and 3, respectively). Bass contributed higher percentages of the catch at dams on the Snake River (0.95%-1.85%) than on the Columbia River (0.08%-0.58%, excluding The Dalles Dam at 3.98%) (Appendix Tables C-1.11, C-1.13, C-1.15). No walleye were caught at Snake River dams, and the 31 (0.12% of total catch) caught at Columbia River dams were released in good condition (Condition 1). As might be expected, shad were proportionately more common in the catch on the Columbia River (0.27% of total) than on the Snake River (0.05% of total). The combined catch of all other species was negligible (0.38% of total for all dams). The vast majority (85.0%) of incidentals were exotic species and species classified as "Other"; the remainder were salmonids and sturgeon.

The quality of information on the incidental impacts of this fishery is very good. Although impacts on salmonids appear to be tolerable, it is the purview of the fishery managers and policy makers to decide whether they indeed are acceptable.

#### RECOMMENDATIONS

1. Continue controlled angling fisheries at all eight dams where angling occurred in 1991.
2. Continue to shape effort at the dams to be more effective and efficient:

<u>Dam</u>	<u>Anqlers</u>	<u>Season &amp; Notes</u>
Bonneville	5	June-Aug.
The Dalles	5	May-Aug. Determine CPAH in May & June
John Day	5	May to mid-Sept.
McNary	5t	June-Aug. Augment crew in peak weeks w/ crew from Ice Harbor and 1-2 temporary anglers.
Ice Harbor	3	June-Aug. Move crew to McNary some days during peak season there.
Lower Monum'l	5	May-Sept.
Little Goose	5	mid-April to mid-Sept. Explore pre-May CPAH.
Lower Granite	5	mid-April through Sept. Explore pre-May CPAH.

3. Augment crews at the dams with a mobile crew of five anglers. Mobile crew would work on the lower Snake River until June, on the lower Columbia River from June through mid-August, and on the Snake River in late August and September.
4. Attempt to use controlled anglers on boats in the boat-restricted zones of some dams (e.g., The Dalles and John Day) where squawfish are known to be abundant but presently inaccessible. An Explorer Sea Scout post in The Dalles and the Yakima Indian Nation are possible participants.
5. Continue to develop controlled volunteer angling options at the dams (Appendix C-2).

6. Construct and install fishing platforms on both sides of the sluiceway outfall at The Dalles Dam.
7. Further improve the accuracy of field data collection.
8. Develop and implement an electronic system for recording and transmitting field data to the central office. This will greatly improve the reliability and timeliness of data transfer.
9. Continue analysis of 1991 data.
10. Continue to explore and develop more effective and acceptable lures and baits for controlled angling fisheries (Appendix C-4).
- 11.** Sacrifice predaceous exotic fishes (i.e., catfish, bass, walleye) caught incidentally in controlled angling fisheries and examine gut contents for salmonids.
12. Promote the development and implementation of effective and efficient squawfish control methods.



## REFERENCES

- Beamesderfer, R. C. and B. E. Rieman. 1988. Predation by resident fish on juvenile salmonids in a mainstem Columbia reservoir: Part III. Abundance and distribution of northern squawfish, walleye, and smallmouth bass. Pages 211-248 in T. P. Poe and B. E. Rieman, editors. Predation by resident fish on juvenile salmonids in John Day Reservoir, 1983-1986. final Report of Research (contracts DE-AI79-82BP34796 and DE-AI79-82BP35097) to Bonneville Power Administration, Portland, Oregon.
- Beamesderfer, R. C. and B. E. Rieman. 1991. Abundance and distribution of northern squawfish, walleyes, and smallmouth bass in John Day Reservoir, Columbia River. Transactions of the American Fisheries Society 120: 439-447.
- Bennett, D. H., P. M. Bratovich, W. Knox, D. Palmer, and H. Hansel. 1983. Status of the warmwater fishery and the potential of improving warmwater fish habitat in the Lower Snake reservoirs. Executive summary of the final report (contract DACW68-79-C0057) to U.S. Army Corps of Engineers, Walla Walla, Washington.
- Bennett, C. H., L. K. Dunsmoor, and J. A. Chandler. 1988. Fish and benthic community abundance at proposed in-water disposal sites in Lower Granite Reservoir, Washington. Completion Report of Department of Fish and Wildlife Resources, University of Idaho to U.S. Army Corps of Engineers, Walla Walla, Washington.
- Bennett, D. H. and F. C. Shrier. 1986. Effects of sediment dredging and in-water disposal on fishes in Lower Granite Reservoir, Idaho-Washington. Completion report (contract DACW68-85-C-0044) to U.S. Army Corps of Engineers, Walla Walla, Washington.
- Buchanan, D. V., R. M. Hooton, and J. R. Moring. 1981. Northern squawfish (*Ptychocheilus oregonensis*) predation on juvenile salmonids in sections of the Willamette River Basin, Oregon. Canadian Journal of Fisheries and Aquatic Sciences 38: 360-364.
- CRFMP (Columbia River Fish Management Plan). 1988. United States et al. v. Oregon Washington et al., (Case No. 68-513).
- Foerster, R. E., and W. E. Ricker. 1938. The effectiveness of predator control in decreasing the mortality of young sockeye salmon (*Oncorhynchus nerka* Walbaum). Verhandlungen Internationale Vereinigung fuer Theoretische und Angewandte Limnologie 8(3): 151-167.
- Foerster, R. E. and W. E. Ricker. 1941. The effect of reduction of predaceous fish on survival of young sockeye salmon at Cultus Lake. Journal of the Fisheries Research Board of Canada 5(4): 315-336.
- Hamilton J. A. R., L. O. Rothfus, M. W. Erho, and J. D. Remington. 1970. Use of a hydroelectric reservoir for the rearing of coho salmon, (*Oncorhynchus kisutch*). State of Washington Department of Fisheries, Research Bulletin Number 9.

- Jeppson, Paul. 1957. The control of squawfish by use of dynamite, spot treatment, and reduction of lake levels. *The Progressive Fish-Culturist* 19: 168-171.
- Jeppson, Paul W. and W. S. Platts. 1959. Ecology and control of the Columbia squawfish in northern Idaho lakes. *Transactions of the American Fisheries Society* 88: 197-202.
- LeMier, E. H., and S. B. Matthews. 1962. Report on the developmental study of techniques for scrapfish control. Final report (contracts 14-17-0001-373 and 14-17-0001-538) to the Bureau of Commercial Fisheries, U.S. Fish and Wildlife Service.
- Li, H. W., C. B. Schreck, C. E. Bond, and E. Rexstad. 1987. Factors influencing changes in fish assemblages of Pacific Northwest streams. Pages 193-202 in W. J. Matthews and D. C. Heins, editors. *Community and evolutionary ecology of North American stream fishes*. University of Oklahoma Press, Norman.
- Meekin, Thomas K. and J. H. Harris. 1967. McNary supplemental spawning channel. Annual report (contract DA 45-164-Civeng-65-4) to U.S. Army Corps of Engineers.
- NMFS (National Marine Fisheries Service). 1991a. Factors for decline, A supplement to the notice of determination for Snake River spring/summer chinook salmon under the Endangered Species Act. National Marine Fisheries Service, Portland, Oregon.
- NMFS (National Marine Fisheries Service). 1991b. Factors for decline, A supplement to the notice of determination for Snake River fall chinook salmon under the Endangered Species Act. National Marine Fisheries Service, Portland, Oregon.
- NPPC (Northwest Power Planning Council). 1986. Compilation of information on salmon and steelhead losses in the Columbia River basin. Northwest Power Planning Council, Portland, Oregon.
- Poe, T. P., and B. E. Rieman, editors. 1988. Predation by resident fish on juvenile salmonids in John Day Reservoir, 1983-1986. Bonneville Power Administration, Portland, Oregon.
- Rieman, B. E., R. C. Beamesderfer, S. Vigg, and T. P. Poe. 1991. Estimated loss of juvenile salmonids to predation by northern squawfish, walleyes, and smallmouth bass in John Day Reservoir, Columbia River. *Transactions of the American Fisheries Society* 120: 448-458.
- Sims, C. W., W. W. Bentley, and R. C. Johnsen. 1977. Effects of power peaking operations on juvenile salmon and steelhead trout migrations - Progress 1976. Final Report of Research (contract DACW68-77-C-0025) to U.S. Army Corps of Engineers.

- Sims, C. W., R. C. Johnsen, and W. W. Bentley. 1976. Effects of power peaking operations on juvenile salmon and steelhead trout migrations 1975. National Marine Fisheries Service, Northwest Fisheries Center Processed Report, Seattle, Washington.
- Thompson, R. B. 1959. Food of the squawfish *Ptychocheilus oregonensis* (Richardson) of the lower Columbia River. U. S. Department of the Interior, Fish and Wildlife Service, Fishery Bulletin 158, Washington, D. C.
- Uremovich, B. L., S.P. Cramer, C. F. Willis, and C. O. Junge. 1980. Passage of juvenile salmonids through the ice-trash sluiceway and squawfish predation at Bonneville Dam, 1980. Annual Progress Report (contract DACW57-78-C-0058) to U.S. Army Corps of Engineers.
- Vigg, S. 1988. Functional response of northern squawfish predation to salmonid prey density in McNary tailrace, Columbia River. Pages 174-207 in T. P. Poe and B. E. Rieman, editors. Predation by resident fish on juvenile salmonids in John Day Reservoir, 1983-1986. Final Report of Research (contracts DE-AI79-82BP34796 and DE-AI79-82BP35097) to Bonneville Power Administration, Portland, Oregon.
- Vigg, S., C. C. Burley, D. L. Ward, C. Mallette, S. Smith, and M. Zimmerman. 1990. Development of a system-wide predator control program: **Stepwise** implementation of a predator index, predator control fisheries, and evaluation plan in the Columbia River Basin. Pages 7-111 in A. A. Nigro, editor. Development of a system-wide predator control program: **Stepwise** implementation of a predation index, predator control fisheries, and evaluation plan in the Columbia River Basin. Annual Report (contract DE-BI79-90BP07084) to Bonneville Power Administration, Portland, Oregon.





## **APPENDIX C-1**

Lure and Bait Descriptions, and Tabular Data Regarding  
Angler Effectiveness and Incidental Catches

Appendix Table C-1.1 Lures and baits used by anglers on the Columbia and Snake River dams in 1991.

Category & type	Description	Color/condition
<b>HARD LURES</b>		
Kastmaster	metal spoon	chrome
Roostertail	metal spinner	black, red
Pro-Lure	metal spoon	yellow, chartreuse
Bangtail	metal spinner	bronze, pink, green
Cripple herring	metal spoon	chrome
Wobl-Fast	metal spoon	chrome
Rat-L-Trap	hard plastic plug, diving	blue, silver, black; in various combinations
Quick Fish	hard plastic plug, diving	orange
Hot Shot	hard plastic plug, diving	rainbow trout
Hi Catch Fingerling	hard plastic plug, diving	fingerling rainbow trout
Chattertail	hard plastic plug, diving	blue, black, silver, chartreuse; various combinations
<b>SOFT LURES</b>		
Grub	3" curtail, plastic	black, blue, brown, white, chartreuse, yellow, olo-in-the-dark
Twin-tailed grub	3" twin tails, plastic	yellow, black, white, chartreuse
Shadling	3" fish, lastic	black/white, black/silver
Nylon jig	nylon cord	white
Miscellaneous	crayfish, squid, worm	various
<b>BAIT</b>		
Salmonid smolts	coho, chinook, steelhead; whole, cut	fresh, fresh frozen, salted frozen
Shrimp	sand, whole	fresh
Lamprey	juvenile, adults; whole, cut	fresh, frozen
Squawfish	adults, belly skin	fresh
Worms	nightcrawler, whole or pieces	fresh
Crayfish	whole, pieces	fresh
Shad	juveniles	fresh
grasshoppers	whole, pieces	fresh

**Appendix** Table c-1.2 Average CPAH for **1991 at Bonneville Dam** by week. Averages were calculated by dividing the number of northern squawfish caught by the total hours fished, which were converted from total minutes fished.

Week number	Total hours fished	Number of northern squawfish	Catch per angler hour
2	188.0	131	0.7
3	116.5	85	0.7
4	<b>159.8</b>	308	1.9
5	<b>159.0</b>	<b>397</b>	2.5
6	139.6	400	2.9
7	160.2	610	3.8
8	156.4	789	5.0
9	133.8	716	5.4
10	184.4	1216	6.6
11	165.0	792	4.8
12	<b>171.1</b>	804	4.7
13	158.7	544	3.4
14	130.1	347	2.7
15	113.6	475	4.2
16	177.7	256	1.4
17	148.4	203	1.4
18	93.2	37	0.4
19	38.0	9	0.2
21	27.9	12	0.4
<b>Seasonal totals</b>	2621.4	8131'	3.1
<b>Means</b>	138.0	427.9	--

'Does not include 57 fish for which minutes fished was not recorded.

Appendix Table c-1.3 Average CPAH for **1991** at The **Dalles** Dam by week. Averages were calculated by dividing the number of northern squawfish caught by the total hours fished, which were converted from total minutes fished.

Week number	Total hours fished	Number of northern squawfish	Catch per angler hour
9	59.7	97	1.6
10	112.9	480	4.2
11	155.9	1012	6.5
12	113.4	373	3.3
13	137.8	192	1.4
14	123.5	288	2.3
15	131.0	408	3.1
16	102.2	218	2.1
17	131.1	135	1.0
18	103.7	121	1.2
19	39.1	160	4.1
20	65.3	122	1.9
21	57.4	68	1.2
Seasonal totals	1333.0	3674'	2.8
Means	102.5	282.6	--

'Does not include 20 fish for which minutes fished was not recorded.

Appendix Table C-1.4 Average CPAH for 1991 at John Day Dam by week. Averages were calculated by dividing the number of northern squawfish caught by the total hours fished, which were converted from total minutes fished.

Week number	Total hours fished	Number of northern squawfish	Catch per angler hour
3	54.0	0	0.0
4	105.5	223	2.1
5	126.9	184	1.5
6	101.6	108	1.1
7	134.3	151	1.1
8	120.8	194	1.6
9	133.0	93	0.7
10	171.6	200	1.2
11	184.7	387	2.1
12	190.2	252	1.3
13	187.1	396	2.1
14	166.3	728	4.4
15	174.9	637	3.6
16	134.7	186	1.4
17	192.8	324	1.7
18	123.1	342	2.8
19	139.2	300	2.2
20	153.7	145	0.9
21	222.1	154	0.7
Seasonal totals	2816.5	5004 <sup>a</sup>	1.8
Means	148.2	263.4	--

<sup>a</sup>Does not include 18 fish for which minutes fished was not recorded.

**Appendix Table C-1.5** Average CPAH for 1991 at **McNary** Dam by week. Averages were calculated by dividing the number of northern squawfish caught by the total hours fished, which were converted from total minutes fished.

Week number	Total hours fished	Number of northern sauawfish	Catch per angler hour
2	78.8	17	0.2
3	141.8	53	0.4
4	100.8	26	0.3
5	220.5	470	2.1
6	155.0	181	1.2
7	219.4	336	1.5
8	210.1	778	3.7
9	134.3	821	6.1
10	186.1	1081	5.8
11	185.4	904	4.9
12	108.5	455	4.2
13	226.0	1654	7.3
14	166.9	532	3.2
15	263.3	312	1.2
16	212.9	195	0.9
17	224.0	129	0.6
18	177.9	106	0.6
19	89.0	125	1.4
20	221.1	140	0.6
21	94.3	33	0.4
Seasonal totals	3416.1	8348'	2.4
Means	170.8	417.4	--

'Does not include 349 fish caught on 7/22 and 7/25 for which actual data records are not available.

**Appendix Table C-1.6 Average CPAH for 1991 at Ice Harbor Dam by week.** Averages were calculated by dividing the number of northern squawfish caught by the total hours fished, which were converted from total minutes fished.

Week number	Total hours fished	Number of northern squawfish	Catch per angler hour
1	<b>63.3</b>	<b>20</b>	<b>0.3</b>
2	101.5	19	0.2
3	75.1	24	0.3
4	96.5	11	0.1
5	110.8	50	0.5
6	106.6	58	0.5
7	70.1	148	2.1
8	103.4	<b>145</b>	1.4
9	114.7	118	1.0
10	118.7	150	1.3
11	119.8	100	0.8
12	113.7	81	0.7
13	100.4	67	0.7
14	97.3	53	0.5
15	120.5	36	0.3
16	131.9	35	0.3
17	88.2	108	1.2
18	89.8	91	1.0
19	81.5	84	1.0
20	91.1	65	0.7
21	57.7	23	0.4
Seasonal totals	<b>2052.6</b>	<b>1486</b>	<b>0.7</b>
Means	97.7	70.8	--



Appendix Table c-1.7 Average CPAH for 1991 at Lower Monumental Dam by week. Averages were calculated by dividing the number of northern squawfish caught by the total hours fished, which were converted from total minutes fished.

Week number	Total hours fished	Number of northern squawfish	Catch per angler hour
1	55.4	13	0.2
2	144.8	83	0.6
3	91.0	129	1.4
4	110.3	64	0.6
5	131.2	321	2.4
6	135.5	300	2.2
7	132.5	264	2.0
8	156.2	258	1.7
9	97.7	200	2.0
10	137.8	269	2.0
11	159.2	286	1.8
12	146.7	221	1.5
13	124.6	224	1.8
14	82.4	34	0.4
15	158.3	29	0.2
16	139.8	57	0.4
17	133.3	103	0.8
18	112.3	196	1.7
19	74.5	132	1.8
20	70.3	58	0.8
21	77.9	72	0.9
Seasonal totals	2471.7	3313 <sup>a</sup>	1.3
Means	117.7	157.8	--

<sup>a</sup>Does not include 22 fish for which minutes fished was not recorded.

Appendix Table C-1.8 Average CPAH for 1991 at Little Goose Dam by week. Averages were calculated by dividing the number of northern squawfish caught by the total hours fished, which were converted from total minutes fished.

Week number	Total hours fished	Number of northern squawfish	Catch per angler hour
1	93.0	402	4.2
2	115.5	638	5.5
3	93.5	273	2.9
4	125.2	303	2.4
5	125.5	304	2.4
6	71.2	254	3.6
7	134.8	427	3.2
8	111.3	249	2.2
9	102.7	198	1.9
10	97.6	84	0.9
11	94.8	107	1.1
12	86.3	92	1.1
13	79.0	118	1.5
14	112.5	124	1.1
15	95.7	132	1.4
16	107.0	120	1.1
17	104.8	341	3.3
18	124.5	347	2.8
19	127.2	316	2.5
20	109.9	76	0.7
21	25.9	10	0.4
Seasonal totals	2137.9	4915	2.3
Means	101.8	234.0	--

**Appendix Table C-1.9 Average CPAH for 1991 at Lower Granite Dam**  
 by week. Averages were calculated by dividing the number of  
 northern squawfish caught by the total hours 'fished, which  
 were converted from total minutes fished.

Week number	Total hours fished	Number of northern squawfish	Catch per angler hour
1	75.1	111	1.5
2	123.0	395	3.2
3	129.2	274	2.1
4	100.8	235	2.3
5	107.4	178	1.7
6	136.9	263	1.9
7	103.0	293	2.8
8	115.2	310	2.7
9	107.6	305	2.8
10	143.1	241	1.7
11	143.1	229	1.6
12	161.4	279	1.7
13	121.6	122	1.0
14	134.3	110	0.8
15	141.7	76	0.5
16	149.6	51	0.3
17	111.3	35	0.3
18	64.7	221	3.4
19	92.1	314	3.4
20	97.5	220	2.3
21	89.5	218	2.4
<b>Seasonal totals</b>	2448.1	4480	1.8
<b>Means</b>	116.6	213.3	--

Appendix Table C-1.10 Catch of northern squawfish and incidental species by condition at release, by month for Columbia River dams. Condition codes: 1) minimal injury, certain to survive; 2) moderate injury, may or may not survive; 3) dead, nearly dead, or certain to die; L) line cut or broken, fish not removed from water.

Month	Northern squaw- fish	Salmonids										Sturseon			Bass			Catfish			Walleve			Shad	Other
		Juvenile			Adult			1	2	3	L	1	2	3	1	2	3	1	2	3					
<b>Bonneville</b>																									
May	524	2	2	0	0	0	0	0	0	0	0	6	0	0	0	0	0	0	0	0	0	0	0	11	1
June	2196	0	0	0	3	0	0	0	0	0	3	0	0	0	0	0	0	0	0	0	0	0	0	12	0
July	4129	0	0	0	0	0	0	0	0	0	0	0	0	0	0	0	0	0	0	0	0	0	0	2	1
August	1281	0	0	0	0	0	0	0	0	0	0	0	0	0	0	0	0	0	0	0	0	0	0	1	6
Sept	58	1	0	0	3	0	0	3	0	0	0	1	0	0	0	0	0	0	0	0	0	0	0	0	0
<b>Total</b>	<b>8188</b>	3	2	0	6	0	0	3	0	0	3	7	0	0	0	0	0	0	0	0	0	0	0	26	8
<b>The Dalles</b>																									
July	2174	10		0	0	0	0	10	0	0	6	77	0	0	0	0	0	10		0	2	0			
August	1049	0	0	0	0	0	0	2	0	0	0	6	3	0	0	0	0	5	0	0	0	14			
Sept	471	0	0	0	0	0	0	0	0	0	0	15	0	0	0	0	0	0	0	0	0	0			
<b>Total</b>	<b>3694</b>	10		0	0	0	0	12	0	0	6	155'	0	0	0	0	0	6	0	0	2	14			
<b>John Dav</b>																									
May	223	0	0	0	10		0	1	0	0	0	10	0	0	2	0	0	0	0	0	0	2			
June	637	0	0	0	10	0		26	0	0	3	3	0	0	9	0	0	1	0	0	22	2			
July	1346	0	0	0	3	0	0	7	0	0	7	7	0	0	2	0	0	2	0	0	11	9			
August	1875	0	0	0	10	0	0	0	0	0	0	5	0	0	9	0	0	9	0	0	0	5			
Sept	941	0	0	0	10	0		14	0	0	0	5	0	0	4	0	0	3	0	0	0	3			
<b>Total</b>	<b>5022</b>	0	0	0	7	0	0	48	0	0	10	30	0	0	26	0	0	15	0	0	33	21			
<b>McNary</b>																									
May	96	0	0	0	3	0	0	0	0	0	0	0	0	0	19	10	10	0	0	0	0	5			
June	1765	0	0	0	10	0		23	0	0	0	5	0	0	122	3	0	0	0	0	1	5			
July	5264	0	0	0	2	0	0	64	10	3		0	0	0	52	0	0	0	0	0	1	4			
August	1168	0	0	0	0	0	0	52	0	0	27	0	0	0	43	2	0	0	0	0	2	1			
Sept	404	4	0	1	3	0	0	39	2	8	15	4	0	0	512	0	9	0	0	10	20				
<b>Total</b>	<b>8697</b>	4	0	1	9	0	0	178	3	8	4	9	0	0	287	8	0	10	0	0	14	35			

'Includes 1 fish for which minutes fished was not recorded.

Appendix Table C-1.11 Species composition of 1991 dam angling catch for Columbia River dams, by month.

Month	Total catch (all species)	Total incidental catch	Percent incidental species in total catch	Percent of total catch (all species)							
				Salmonids		Sturgeon	Bass	Catfish	Walleye	Shad	Other
				Juvenile	Adult						
<b>Bonneville</b>											
<b>May</b>	546	22	4.03	0.73	0.00	0.00	1.10	0.00	0.00	2.01	0.18
June	2214	18	0.81	0.00	0.14	0.14	0.00	0.00	0.00	0.54	0.00
July	4132	3	0.07	0.00	0.00	0.00	0.00	0.00	0.00	0.05	0.02
August	1288	7	0.54	0.00	0.00	0.00	0.00	0.00	0.00	0.08	0.47
September	66	8	12.12	1.52	4.55	4.55	1.52	0.00	0.00	0.00	0.00
<b>Total</b>	<b>8246</b>	<b>58</b>	<b>0.70</b>	<b>0.06</b>	<b>0.07</b>	<b>0.07</b>	<b>0.08</b>	<b>0.00</b>	<b>0.00</b>	<b>0.32</b>	<b>0.10</b>
<b>The Dalles</b>											
July	2271	97	4.31	0.04	0.00	0.71	3.42	0.00	0.04	0.09	0.00
August	1133	84	7.41	0.00	0.00	0.18	5.56	0.00	0.44	0.00	1.24
September	486	15	3.09	0.00	0.00	0.00	3.09	0.00	0.00	0.00	0.00
<b>Total</b>	<b>3890'</b>	<b>196'</b>	<b>5.04</b>	<b>0.03</b>	<b>0.00</b>	<b>0.46</b>	<b>3.98'</b>	<b>0.00</b>	<b>0.15</b>	<b>0.05</b>	<b>0.36</b>
<b>John Day</b>											
<b>May</b>	239	16	6.69	0.00	0.42	0.42	4.18	0.84	0.00	0.00	0.84
June	704	67	9.52	0.00	0.14	4.12	0.43	1.28	0.14	3.13	0.28
July	1394	48	3.44	0.00	0.22	1.00	0.50	0.14	0.14	0.79	0.65
August	1904	29	1.52	0.00	0.05	0.00	0.26	0.47	0.47	0.00	0.26
September	971	30	3.09	0.00	0.10	1.44	0.51	0.41	0.31	0.00	0.31
<b>Total</b>	<b>5212</b>	<b>190</b>	<b>3.65</b>	<b>0.00</b>	<b>0.13</b>	<b>1.11</b>	<b>0.58</b>	<b>0.50</b>	<b>0.29</b>	<b>0.63</b>	<b>0.40</b>
<b>McNary</b>											
<b>May</b>	125	29	23.20	0.00	2.40	0.00	0.00	16.00	0.80	0.00	4.00
June	1925	160	8.31	0.00	0.05	1.19	0.26	6.49	0.00	0.05	0.26
July	5391	127	2.36	0.00	0.04	1.26	0.00	0.96	0.00	0.02	0.07
August	1295	127	9.81	0.00	0.00	6.10	0.00	3.47	0.00	0.15	0.08
September	572	168	29.37	0.87	0.52	11.19	0.70	9.27	1.57	1.75	3.50
<b>Total</b>	<b>9308</b>	<b>611</b>	<b>6.56</b>	<b>0.06</b>	<b>0.10</b>	<b>2.51</b>	<b>0.10</b>	<b>3.17</b>	<b>0.11</b>	<b>0.15</b>	<b>0.38</b>

'Includes 1 fish for which minutes fished was not recorded.

**Appendix Table C-1.12** Catch of northern squawfish and incidental species by condition at release, by month for Snake River dams. Condition codes: 1) minimal injury, certain to survive; 2) moderate injury, may or may not survive; 3) dead, nearly dead, or certain to die; L) line cut or broken, fish not removed from water.

Month	Northern squaw- fish	Salmonids																Shad	Other							
		Juvenile						Adult				Sturseon				Bass				Catfish			Walleve			
		1	2	3	1	2	3	1	2	3	L	1	2	3	1	2	3			1	2	3				
<u>Ice Harbor</u>																										
May	74	01		0	2	0	0	0	0	0	1	6	0	0	57	0	3	0	0	0	0	4				
June	401	0	0	0	0	0	0	0	0	0	0	0	0	0	228	7	3	0	0	0	2	1				
July	516	0	0	0	0	0	0	17	0	0	9	9	0	0	282	0	0	0	0	0	5	3				
August	232	0	0	0	0	0	0	12	0	0	12	16	0	0	187	0	0	0	0	0	0	8				
Sept	263	0	0	0	0	0	0	4	0	2	2	0	0	0	410	0	0	0	0	0	0	0				
<b>Total</b>	<b>1486</b>	01		0	2	0	0	33	0	2	24	31	0	0	795	7	6	0	0	0	7	16				
<u>Lower Monumental</u>																										
May	292	11	0	0	4	0	0	0	0	0	0	7	0	0	23	0	0	0	0	0	1	4				
June	1153	3	0	0	10		0	0	0	0	0	12	2	0	141	5	2	0	0	0	0	2				
July	1208	10		0	0	0	0	0	0	0	0	10	1	0	275	11	5	0	0	0	0	5				
August	224	0	0	0	0	0	1	3	0	0	0	26	0	0	192	3	2	0	0	0	0	1				
Sept	458	11	1	0	2	0	0	0	0	0	0	17	2	0	2101	0	0	0	0	0	0	8				
<b>Total</b>	<b>3335</b>	26	1	0	7	0	1	33	0	0	0	72	5	0	652	19	10	0	0	0	1	20				
<u>Little Goose</u>																										
May	1616	0	0	0	3	0	0	0	0	0	0	3	0	0	93	31	0	0	0	0	0	15				
June	1234	0	0	0	2	0	0	0	0	0	0	8	0	0	84	3	0	0	0	0	0	12				
July	599	13	1	1	0	0	0	1	0	0	0	17	0	0	10	10	0	0	0	0	0	4				
August	717	3	2	1	0	0	0	0	0	0	0	2110		10	0	0	0	0	0	0	0	9				
Sept	749	2	0	0	0	0	0	0	0	0	0	0	0	0	13	0	0	0	0	0	0	1				
<b>Total</b>	<b>4915</b>	18	3	2	5	0	0	10	0	0	0	49	1	0	201	7	1	0	0	0	0	41				
<u>Lower Granite</u>																										
May	1015	0	0	1	0	0	0	0	0	0	0	19	0	143	0	2	0	0	0	0	0	3				
June	1044	0	0	0	2	0	0	3	0	0	01	17	0	0	69	01	0	0	0	0	0	2				
July	1176	0	0	0	0	0	0	1	0	0	0	6	0	0	39	01	0	0	0	0	0	2				
August	272	0	0	0	0	0	0	0	0	0	0	12	0	0	21	0	0	0	0	0	0	1				
Sept	973	10	0	0	0	0	0	0	0	0	0	8	0	0	8	0	0	0	0	0	0	3				
<b>Total</b>	<b>4480</b>	10	0	1	2	0	0	4	0	0	1	62	0	1	180	0	4	0	0	0	0	11				

'Includes 10 fish for which minutes fished was not recorded.

Appendix Table C-1.13 Species composition of 1991 dam angling catch for Snake River dams, by month.

Month	Total catch (all species)	Total incidental catch	Percent incidental species in total catch	Percent of total catch (all species)							
				Salmonids		Sturgeon	Bass	Catfish	Walleye	Shad	Other
				Juvenile	Adult						
<u>Ice Harbor</u>											
May	148	74	50.00	0.68	1.35	0.68	4.05	40.54	0.00	0.00	2.70
June	642	241	37.54	0.00	0.00	0.00	0.00	37.07	0.00	0.31	0.16
July	841	325	38.64	0.00	0.00	3.09	1.07	33.53	0.00	0.59	0.36
August	467	235	50.32	0.00	0.00	5.14	3.43	40.04	0.00	0.00	1.71
September	312	49	15.71	0.00	0.00	2.56	0.00	13.14	0.00	0.00	0.00
<b>Total</b>	<b>2410</b>	<b>924</b>	<b>38.34</b>	<b>0.04</b>	<b>0.08</b>	<b>2.45</b>	<b>1.29</b>	<b>33.53</b>	<b>0.00</b>	<b>0.29</b>	<b>0.66</b>
<u>Lower Monumental</u>											
May	342	50	14.62	3.22	1.17	0.00	2.06	6.73	0.00	0.29	1.17
June	1321	168	12.72	0.23	0.08	0.00	1.06	11.20	0.00	0.00	0.15
July	1516	308	20.32	0.07	0.00	0.00	0.73	19.20	0.00	0.00	0.33
August	452	228	50.44	0.00	0.22	0.66	5.75	44.58	0.00	0.00	0.22
September	521	63	12.09	2.30	0.38	0.00	3.65	4.22	0.00	0.00	1.54
<b>Total</b>	<b>4152'</b>	<b>817'</b>	<b>19.68</b>	<b>0.65</b>	<b>0.19</b>	<b>0.07</b>	<b>1.85</b>	<b>16.40'</b>	<b>0.00</b>	<b>0.02</b>	<b>0.48</b>
<u>Little Goose</u>											
May	1734	118	6.81	0.00	0.17	0.00	0.17	5.59	0.00	0.00	0.87
June	1343	109	8.12	0.00	0.15	0.00	0.60	6.48	0.00	0.00	0.89
July	647	48	7.42	2.32	0.00	0.15	2.63	1.70	0.00	0.00	0.62
August	755	38	5.03	0.79	0.00	0.00	2.91	0.13	0.00	0.00	1.19
September	765	16	2.09	0.26	0.00	0.00	0.00	1.70	0.00	0.00	0.13
<b>Total</b>	<b>5244</b>	<b>329</b>	<b>6.27</b>	<b>0.44</b>	<b>0.10</b>	<b>0.02</b>	<b>0.95</b>	<b>3.99</b>	<b>0.00</b>	<b>0.00</b>	<b>0.78</b>
<u>Lower Granite</u>											
May	1084	69	6.37	0.09	0.00	0.00	1.85	4.15	0.00	0.00	0.28
June	1139	95	8.34	0.00	0.18	0.35	1.49	6.15	0.00	0.00	0.18
July	1225	49	4.00	0.00	0.00	0.08	0.49	3.27	0.00	0.00	0.16
August	306	34	11.11	0.00	0.00	0.00	3.92	6.86	0.00	0.00	0.33
September	1002	29	2.89	1.00	0.00	0.00	0.80	0.80	0.00	0.00	0.30
<b>Total</b>	<b>4756</b>	<b>276</b>	<b>5.80</b>	<b>0.23</b>	<b>0.04</b>	<b>0.11</b>	<b>1.32</b>	<b>3.87</b>	<b>0.00</b>	<b>0.00</b>	<b>0.23</b>

'Includes 10 fish for which minutes fished was not recorded.

**Appendix Table C-1.14** Total catch of northern squawfish and incidental species by condition at release for Columbia and Snake River dams. Condition codes: 1) minimal injury, certain to survive; 2) moderate injury, may or maynot survive; 3) dead, nearly dead, or certain to die; L) line cut or broken, fish not removed from water.

Northern squaw- fish	Salmonids						Sturgeon				Bass			Catfish			Walleye			Shad	Other	
	Juvenile			Adult			1	2	3	L	1	2	3	1	2	3	1	2	3			
	1	2	3	1	2	3																
<u>Columbia R.</u>																						
25601	8	2	1	2	2	0	0	241	3	8	64	201'	0	0	313	8	0	31	0	0	75	78
<u>Snake R.</u>																						
14216	54	5	3	16	0	1	41	0	2	25	214	6	1	<b>1828<sup>b</sup></b>	33	21	0	0	0	8	88	
<u>Grand Total</u>																						
39817	62	7	4	38	0	1	282	3	10	89	415'	6	1	<b>2141<sup>b</sup></b>	41	21	31	0	0	83	166	

<sup>a</sup>Includes 1 fish for which minutes fished was not recorded.

<sup>b</sup>Includes 10 fish for which minutes fished was not recorded.



Appendix Table C-1.15 Species composition totals of 1991 dam angling catch for Columbia and Snake River dams.

	Total catch (all species)	Total incidental catch	Percent incidental species in total catch	Percent of total catch (all species)							
				<u>Salmonids</u>		Sturgeon	Bass	Catfish	Walleye	Shad	Other
			Juvenile	Adult							
<u>Columbia R.</u>	26656 <sup>a</sup>	1055'	3.96	0.04	0.08	1.18	0.75'	1.20	0.12	0.28	0.29
<u>Snake R.</u>	16562 <sup>b</sup>	2346 <sup>b</sup>	14.18	0.37	0.10	0.41	1.33	11.36 <sup>b</sup>	0.00	0.05	0.53
<u>Grand total</u>	43218'	3401'	7.87	0.17	0.09	0.90	0.89'	5.10 <sup>b</sup>	0.07	0.19	0.38

<sup>a</sup>Includes 1 fish for which minutes fished was not recorded.

<sup>b</sup>Includes 10 fish for which minutes fished was not recorded.

'Includes 11 fish for which minutes fished was not recorded.

APPENDIX C-2

Using Volunteers in Dam Angling Fisheries

## BACKGROUND

Methods that are efficient and socially responsive, as well as effective, are desirable for achieving predator control objectives. Using supervised volunteers to angle for northern squawfish in restricted areas at mainstem dams may improve the effectiveness and efficiency of controlled angling fisheries and provide some social benefits. Potential social benefits include 1) a greater understanding of fish resource issues in general and the Predator Control Program in particular among members of the public and 2) improved relations between the public and fishery management organizations, among others.

A secondary objective of our work in 1991 was to evaluate the feasibility of using supervised volunteers in the dam angling fishery. At the onset we identified several factors that would affect the results of such an evaluation:

1. The willingness of the U.S. Army Corps of Engineers (USACE) to grant access to volunteer anglers;
2. The local availability of willing and able volunteers; and
3. The ability of CRITFC or other responsible management entity to adequately organize and supervise the volunteers.

## APPROACH

We targeted The Dalles and Ice Harbor dams as potential sites for the evaluation because of their proximity to urban centers with expected pools of anglers. Bonneville Dam first powerhouse, based on angling in previous years, promised sufficiently good catches to attract volunteers from the Portland/Vancouver area, but was the site of much construction, fish passage studies, and many other predator control activities in the summer of 1991. Hence we did not propose a test at Bonneville Dam in 1991.

If the Corps, with its concerns for personal safety and site security, was receptive to our proposal, then we would contact local sportsmen's groups as potential sources of volunteers. We proposed:

1. Close supervision of volunteers by trained technicians employed by CRITFC; no more than 4 volunteers per technician.
2. No more than 8 volunteers on site at any one time.
3. All volunteers would use the same safety equipment required of angling technicians: hard hat, safety shoes, and life vests and safety restraints where conditions require.
4. Volunteers and their supervisory technician(s) would arrive at and depart the dam together in CRITFC vehicles.

5. The volunteer crew would fish during the hours and days when more volunteers were available.

Given approval by the Corps and recruitment of suitable volunteers, specially qualified members of CRITFC angling crews would be trained and organized to coordinate with, assist, and supervise the volunteers. Volunteer angling would begin only after the crew of angling technicians was well-established at the dam.

## RESULTS

Personnel from the USACE, during pre-season coordination meetings at The Dalles and Ice Harbor dams, granted qualified approval of the proposal. The Corps required that a list of the anglers' names and social security numbers be provided in advance and that during non-business hours the crew would remain on site throughout their shift to minimize traffic through security gates. (Extraordinary security measures had been implemented because of the Persian Gulf War.)

We did not attempt to recruit volunteer anglers for Ice Harbor Dam for two reasons: 1) catch rates of northern squawfish by our crew of technicians were very low in May and early June (0.1-0.5 northern squawfish per angler hour), and 2) there were some difficulties between the Corps and our angling crew. We concluded that low catch rates would not attract the interest of volunteer anglers (particularly when the sport reward fishery seemed so promising) and that the personnel situation at that dam could not bear the added responsibility of hosting volunteer anglers.

We did not use volunteers at The Dalles Dam, although we did meet with prospective volunteers. Efforts to obtain safe access to the most productive angling areas at The Dalles Dam (on either side of the sluiceway outfall) contributed to a late start for our angling crew there. We were unable to construct platforms for fishing in these areas this year. The Corps had originally ruled that our angling technicians could not work beside the sluiceway outfall without fishing platforms, but later allowed access under strict safety measures. The low productivity of other areas and the hazards of fishing in the vicinity of the sluiceway made The Dalles Dam a difficult site to use volunteer anglers this year.

Patty Farthing, STEP biologist for ODFW in The Dalles, provided contacts for two sportsmen's groups that could be sources of volunteer anglers: The Dalles Rod and Gun Club and the Mid-Columbia Chapter of the Northwest Steelheaders. CRITFC's Project Leader attended the September meeting of The Dalles Rod and Gun Club, where the Predator Control Program and other fish passage issues were discussed. Club members in attendance, none of whom had participated in the sport reward fishery, were interested in volunteering as anglers in 1992, provided that fishing platforms were available at the sluiceway outfall. The Mid-Columbia Chapter of the Northwest Steelheaders will not hold its first regular meeting of the season until November. CRITFC Project Leaders will attempt to meet with the organization at that time or soon thereafter.

## CONCLUSIONS AND RECOMMENDATIONS

1. Volunteer angling remains a worthy idea for continued development in 1992 where favorable conditions exist.
2. The Corps will allow responsibly managed volunteer fisheries for northern squawfish on some dams.
3. Because of low catch rates, a volunteer angling effort at Ice Harbor Dam would probably attract few participants. We recommend not developing the option further at this site.
4. Volunteer angling at The Dalles Dam remains a viable option. Fishing platforms would be required to gain safe access to the productive areas at the sluiceway outfall. This work should proceed in 1992.
5. Despite all of the other activity, some volunteer angling may be possible at Bonneville Dam in 1992. We recommend that this be proposed to the Corps and that potential volunteers be contacted.
6. Good relationships between the volunteers and the technicians that will assist and supervise them are essential, particularly if tribal and non-tribal persons are involved. We recommend great care in the selection of technicians, the orientation of volunteers, and the oversight by project leaders to ensure that this effort is constructive.

APPENDIX C-3

Private Firms Interested in Participating  
in Dam Angling Fisheries

To ensure that all eight dams would be staffed with anglers in 1991, we compiled a list of consultants interested in bidding for subcontracts to conduct the fisheries at some dams. These parties would have been contacted in the event that CRITFC itself was unable to mount a full field effort. Inquiries were mailed to 10 consultants, and affirmative responses were received from (order is alphabetical):

<u>Firm</u>	<u>Contact Person</u>
<b><i>Biomark</i></b> 11042 Forest Lane NE Bainbridge Island, WA 98110  (206) 842-0473 FAX: (206) 842-5472	<b><i>Donn L. Park</i></b>
<b><i>CH<sub>2</sub>MHill</i></b> PO Box 15000 Bellevue, WA 98009-2050  (206) 453-5000	<b><i>Gaylene Tupen</i></b>
<b><i>Harza Northwest, Inc.</i></b> PO Box C-96900 Bellevue, WA 98009  (206) 882-2455 FAX: (206) 883-7555	<b><i>Chas. Gowan</i></b>
<b><i>Pentec Environmental</i></b> 120 West Dayton, Suite A7 Edmonds, WA 98020  (206) 775-4682 FAX: (206) 778-9417	<b><i>Nicholas J. Bax</i></b>

APPENDIX C-4

Availability, Distribution, and Use of Some Natural Baits



## BACKGROUND

Dead juvenile salmonids were shown to be relatively effective bait in dam angling (C. Burley, Washington Department of Wildlife (WDW), personal communication) and longline (Mathews and Iverson 1990) fisheries for northern squawfish in 1990 and in earlier work. Therefore, and because we desired an effective standard for evaluating alternative baits, juvenile salmonids were sought for use as bait in the 1991 dam angling fishery. Researchers from the University of Washington (UW) and the Oregon Department of Fish and Wildlife (ODFW) also wished to have salmonid bait available for the longline fishery, and we wished to ascertain the constraints on selling the bait to longline fisherpersons through established retail bait outlets. There are, however, social and legal concerns about using, as bait, the very animals that are the objects of our concern and the motivation for our work.

We investigated many aspects of using juvenile salmonids for bait in these fisheries -- including availability, regulations and policies that apply to distribution and use, and private sector outlets. The objective was to find or develop sources and a distribution system that was usable, particularly for the longline fishery. Hence we did not try to identify all constraints in all jurisdictions.

We also investigated the availability, costs, and distribution of bait shrimp for use in the two fisheries.

## SALMONIDS

### Availability

Public and private hatcheries and fish found in natural waters (mixture of hatchery and natural origins) are the primary sources for this bait. In-river fish have been used in the past and were used again this year, but no fish were killed for this purpose. Two dams on the Snake River (i.e., Lower Granite and Little Goose) and one on the lower Columbia River (i.e., McNary) collect juveniles from the river and hold them in raceways for loading into barges and trucks. A small percentage of these fish die in the collection and holding process. These mortalities are removed from the raceways by Corps employees and would usually be disposed of in the river. However, with the permission of the Corps and the Fish Passage Advisory Committee of the Columbia Basin Fish and Wildlife Authority, these dead fish can be and have been used for bait in 1990 and 1991 dam angling fisheries, but have not been considered for distribution to other fisheries through the private-sector.

Except for some dead fish, which may be used at the time and dam where collected, all juvenile salmonid bait requires some processing, packaging, storage, and/or distribution (Mathews and Iverson 1990). Freezing in plastic bags is a simple method for processing and storage, but freezing makes the bait (particularly small fish) very soft and difficult to keep on a hook. Salting before freezing toughens the bait, but requires considerably more labor and results in a bait that seems less attractive to squawfish (Mathews and Iverson 1990; our results). Freshly killed bait (e.g., juveniles obtained from public or private hatcheries that are kept alive until 1-2 days before

use) would be nearly ideal if the method did not run afoul of live fish (and disease) transfer policies and require an intensive distribution effort. Matching supply and demand in a way that produces the best bait remains problematic.

#### Public Hatcheries

We contacted managers in the fish culture divisions of Oregon and Washington fish management agencies and the US Fish and Wildlife Service (USFWS) to determine if suitable fish might be available from their hatcheries. Whether these fish could be distributed and used as we desired is addressed in the next section. After consulting with fish pathologists from Oregon (Document C-4.1) and Washington (Kevin Amos, Washington Department of Fisheries (WDF), personal communication), we decided to limit our use to fish that were alive at the time of harvest, because of policies and concerns regarding transfer of pathogen-bearing hatchery mortalities. In general, no agency had foreknowledge of surpluses of suitable bait fish that would be available before or during the 1991 fisheries.

Oregon Department of Fish and Wildlife (Document C-4.2), WDW (J. Kerwin, personal communication, 2/91), and USFWS (Document C-4.3) approved our use of surpluses of suitable fish at their hatcheries, if any became available; WDF did not (Doc. C-4.4). Some bait fish were eventually obtained from one National Fish Hatchery (via USFWS), and one offer of unsuitable (too small) fish from ODFW was declined. Generally, public hatchery fish that are surplus are disposed of when they are too small for use as bait. Exceptions are some coho and steelhead that are culled in the fall, months before they would be used as bait.

#### Private Hatcheries

We also contacted 15 private aquaculturists in Washington from a list provided by WDF (L. Peck, personal communication, 3/91). A similar list of Oregon aquaculturists in Oregon was obtained later from ODFW (R. Hooton, personal communication, 4/91), but none of the Oregon growers were contacted. Five Washington aquaculturists responded to our initial letter. One had no surplus; three had some coho that were larger ( $\geq 20$  g) than desired (5-10 g) and were asking prices that exceeded our ceiling of \$0.10/fish. More information on these aquaculturists is available on request. We eventually purchased some surplus coho that met specifications from the fifth aquaculturist, Domsea Farms, Inc. Other suitable Domsea fish at a reasonable price ( $\leq$  \$0.04/fish) were declined in July, when it appeared that the longline fishery would have little demand for the bait.

Most of the responding firms expressed a desire to contract to rear bait fish (coho), either from their own or some other broodstock. Such contracts would have to be executed before spawning, in the summer or fall of the year before the fish would be used, and the per-fish costs would be approximately \$0.03 to \$0.01/gram average weight. Uncertain demand, constraints on obligating funds for the next budget year, and relatively high costs make contract rearing relatively infeasible.

In general, suitable bait fish will be available at a reasonable price from private growers only under exceptional circumstances. If contracting for

rearing is not feasible, then an uncertain supply of bait may be available in the spring and summer of the year when needed, but those fish may not be very suitable (e.g., in size and price). Domsea was being sold and had to liquidate their stock at the time we purchased fish from them, and the low prices allowed partial recovery of sunk costs from fish that would otherwise have been destroyed.

### Distribution and Use

State authorities hold jurisdiction over the distribution and use of juvenile salmon and steelhead in the non-reservation areas of the states. Here we present the results of our investigation into state regulations and policies of Washington, Oregon, and Idaho that might constrain the use of these fish for bait in dam angling and longline fisheries.

#### Washington

Washington State regulations distinguish between fish produced by private growers and fish produced by public hatcheries. Salmonids produced by private growers are not regulated by either WDF or WDW (Document C-4.5, p. 1), although the Washington Department of Agriculture requires appropriate labelling of the product from the time of sale by the producer to the point of retail sale (Document C-4.6). No licenses or permits are required by the state for distribution and use of these fish (Document C-4.5, pp. 1-Z).

The distribution and use of fish produced in public hatcheries is more restricted, and different regulations apply to game fish and to food fish. Most uses of game fish (e.g., juvenile trout produced by WDW or other public hatcheries) in Washington are subject to a blanket statutory prohibition, except for activities specifically authorized by law or rule (Document C-4.5, p. 2). There appear to be no exceptions that would allow the sale, in Washington, of game fish produced in public hatcheries, and it is not clear whether free distribution would be permissible. Even if game fish were available from public hatcheries in Washington or elsewhere, a more detailed review of state regulations would be necessary to ensure that these fish could be transported, distributed, and/or used as bait within the state.

Food fish (e.g., salmon) produced by public hatcheries may be distributed for use as bait in Washington, but a wholesale fish dealer's license is required if the fish are commercially processed or sold to a retailer that did not have its own wholesale dealer's license (Document C-4.5, pp. 2-3). For CRITFC, paying for a state license would raise the issue of tribal sovereignty. Distributing the bait all the way down to the end user without buying, selling, or bartering would not be commercial activity, hence no license is required (Document C-4.5, p. 3). Other methods of using retail outlets to distribute bait may also be outside the definition of commercial activity (Document C-4.5, p. 4). The state requests that all food fish used for bait be packaged and labelled in a manner that makes the origin of the fish readily identifiable (Document C-4.5, pp. 3-4).

#### Oregon

The laws and regulations of Oregon allow the distribution (including sale) and use of juvenile salmonids (< 15 in. in length) for squawfish bait,

although some action by the Oregon Fish and Wildlife Commission may be appropriate in the future to address the sale of these game fish (Document C-4.7). Oregon is concerned that a clear administrative record be kept of the source and ultimate disposition of the bait fish (Document C-4.7).

Of the three northwest states that we contacted, Oregon appears to have the most favorable regulatory climate for distributing and using salmonid bait in fisheries for northern squawfish. Hence, we focussed on developing a distribution system in Oregon for bait for the longline fishery. We contacted seven Oregon retail bait dealers in the vicinity of Bonneville Pool to identify potential outlets for salmonid bait for the longline fishery (list of vendors provided by C. Mallette, ODFW). Two of the vendors responded that they would be interested in retailing this bait. (More information on these bait dealers is available from the authors.) However, no salmonid bait was distributed in 1991 to the longline fisherpersons through the private sector. Demand for the bait, even when distributed gratis, was never great, and researchers administering the longline fishery decided that the cost of this bait, if sold through retail outlets, would be an undue economic burden for longline fisherpersons.

Idaho

The State of Idaho does not endorse or sanction the distribution of juvenile salmonids for squawfish bait (Document C-4.8) in that state. Salmonids are used as bait in some fisheries in Idaho, but the fisherperson must acquire that bait in accordance with the regulations applicable to the catch and retention of those salmonid species (A. Van Vooren, personal communication, 1/91).

#### SHRIMP

Sand shrimp (also known as ghost shrimp) and/or mud shrimp are other natural baits that may be effective in longline and dam angling fisheries for northern squawfish (Mathews and Iverson 1990). We contacted three commercial harvesters of sand and mud shrimp on the Oregon and Washington coasts to determine availability and costs. More information on these and other harvesters is available on request from the authors.

Sand shrimp do not freeze well (i.e., they are very soft when thawed), but they can be kept fresh up to 10 d when refrigerated at 40°F. Harvesters can deliver to Portland on 1-4 d notice and as frequently as once or twice weekly. Wholesale prices for fresh sand shrimp in the spring of 1991 ranged approximately from \$0.75 to \$1.35 per dozen, depending in part on whether the product condition was guaranteed.

Compared to sand shrimp, mud shrimp tend to be smaller, darker in color, and better suited for freezing. Only one of the three harvesters contacted did not deal in mud shrimp. Prices are similar to those of sand shrimp, although a ready supply and lower demand, particularly for smaller shrimp, can result in prices about \$0.10 per dozen less. One harvester reports that the shelf life of fresh mud shrimp is shorter than that of fresh sand shrimp, perhaps only 2-3 d.

These shrimps are commonly used baits in local recreational fisheries, and a distribution system already exists for them. However, quantities demanded by an active longline fishery or a dam angling fishery for squawfish could exceed the inventories usually maintained by bait retailers for recreational fisherpersons. In May we informed seven retailers in the Bonneville Pool area about the sources of bait shrimp that we had identified, but otherwise did not attempt to develop further the distribution system for bait shrimp for the benefit of the longline fishery.

Only on a couple of occasions were sand shrimp, obtained from local retail bait dealers, used in the dam angling fishery. The shrimp were costly, but appeared to work well. We intend to test these baits further in 1992, and will probably purchase larger quantities of fresh and frozen shrimp directly from harvesters. Storage and distribution to the dams will require much care, particularly for fresh bait with its relatively short shelf life.

#### CONCLUSIONS AND RECOMMENDATIONS

1. Many constraints make juvenile salmonids difficult to use for bait, particularly in the northern squawfish fisheries that are more public. There are many sources of this bait, but obtaining a reliable supply of suitable fish will be costly and require early commitments.
2. Both Oregon and Washington have regulations allowing, under certain conditions, the private sector to distribute and use juvenile salmonids for bait; Idaho does not.
3. We recommend that fisheries conducted exclusively by fishery management or research organizations (e.g., controlled angling, trials of other baited gears) continue discrete use of juvenile salmonids that would otherwise be disposed of. These fish include mortalities at transportation collector dams and surpluses from public and private hatcheries where such use is administratively permissible.
4. We also recommend discontinuation of attempts by fishery management and research organizations to develop sources and a distribution system for salmonid bait to support fisheries that are more public in nature (e.g., subsidized commercial, sport reward). Regulatory conditions in Washington and Oregon allow private enterprise to satisfy demands that may develop in these fisheries, and we received an inquiry from a wholesale bait dealer that suggests awareness of and interest in this opportunity is growing.
5. Bait shrimp should be further evaluated in controlled angling fisheries in 1992.

## REFERENCE

- Mathews, S. B., and T. K. Iverson. 1990. Evaluation of Harvest Technology for potential squawfish commercial fisheries in Columbia River reservoirs. [DRAFT] Report C in A. A. Nigro, editor. Development of a system-wide predator control program: Stepwise implementation of a predation index, predator control fisheries, and evaluation plan in the Columbia River Basin. Annual Report (contract DE-BI79-90BP07084) to Bonneville Power Administration, Portland, Oregon.

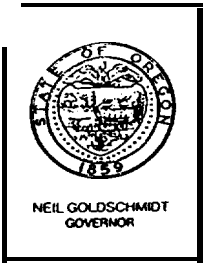

*Department of Fish and Wildlife*  
**COLUMBIA REGIONAL OFFICE**

17330 SE EVELYN STREET. CLACKAMAS, OREGON 97015 PHONE (503)657-2000

January 10, 1991

RECEIVED

JAN 14 1991

Mr. Roy B'eaty  
Columbia River Inter-Tribal Fish Commission  
975 S.E. Sandy Boulevard  
Suite 202  
Portland, OR 97214

COLUMBIA RIVER INTER-  
TRIBAL FISH COMMISSION  
PORTLAND, OREGON

RE: Response to your letter January 7, 1991

Dear Roy:

After considering the use of salmonid mortality for squawfish bait, it was decided that this is not a good idea because our policy is all mortality is buried rather than released into the hatchery watershed. The reason is that mortality generally carries a high load of pathogenic agents and we do not want to "seed" the hatchery watershed with undesirable disease agents. This policy also applies to private hatcheries so to maintain consistency in not allowing mortalities to be present in any river situation, the use of hatchery mortality should not be considered.

It is okay to use live healthy hatchery salmonids if a surplus or gradeouts are available. The only restriction here is that there is no active epizootic occurring. I don't know if any Columbia Gorge Station has any surplus or gradeouts, so for the future you might want to set some money aside for certain hatcheries to rear some excess production fish for squawfish bait. I suggest you contact Trent Stickell (229-5410 extension 386) to talk about using excess fish from our hatcheries for squawfish bait.

If any further questions feel free to give me a call.

Sincerely,

Terry D. Kreps  
Pathologist

tkn



# Department of Fish and Wildlife

2501 SW FIRST AVENUE, PO BOX 59. PORTLAND. OREGON 97207 PHONE (503) 229-5400

January 15, 1991

RECEIVED

JAN 17 1991.

COLUMBIA RIVER INTER-TRIBAL FISH COMMISSION  
PORTLAND, OREGON

Mr. Roy E. Beatty  
CRITFC  
975 S.E. Sandy Blvd., Suite 202  
Portland, OR 97214

RE: Use of Surplus Production and Mortalities of Juvenile Salmonids at ODFW Hatcheries for Squawfish Bait

Dear Roy:

The Oregon Department of Fish and Wildlife is willing to cooperate with CRITFC in what we feel is a very valuable project. We will make every attempt to satisfy needs for surplus and mortality salmonids from our fish propagation facilities.

Department needs must be met first so the only fish we will be able to provide you will be true surpluses. Any moribund fish must be cleared with our fish pathologist before they are to be used in the bait program. In order to make the process run smoothly your requests need to be directed to our Hatchery Production/Operations Coordinator, Trent Stickell, in our Portland office at 229-5410, ext. 386. Trent usually knows of any surpluses or mortalities and is familiar with Department procedure. Funnel all requests through your office to him to avoid confusion. Please allow Trent five working days to process your request. Provide him with the number and size desired, then he will make the necessary arrangements and notify your office.

Sincerely,

Chris Christianson  
Director Fish Propagation Program

rrt

c D. DeHart  
E. Wagner  
T. Nigro

R. Sheldon  
H. Lorz  
K. Witty

D. Walker  
B. Mullen

m011502t





**United States Department of the Interior**  
**FISH AND WILDLIFE SERVICE**

911 N.E. 11th Avenue  
Portland, Oregon 972324181

February 22, 1991

Mr. Roy E. Beaty  
Columbia River Inter-Tribal Fish Commission  
975 S.E. Sandy Boulevard, Suite 202  
Portland, Oregon 97214

Dear Mr. Beaty:

In response to your letter of January 24, 1991 we submit the following.

Juvenile salmonids of the size you requested for the squawfish control fisheries are not normally available from National Fish Hatcheries, because their production capacities are used to meet management requirements. Normal mortality from the hatcheries could be saved for you however, only fish from hatcheries without a history of IHN could be used in the mainstem of the Columbia River.

The best contact point would be through our office. We have a policy that does not allow any fish (dead or alive) to leave our hatcheries without the appropriate State Transportation permit.

Please contact Tom Sheldrake of my office at 503-230-5972 for any further details.

Sincerely,

Daniel H. Diggs  
Associate Manager  
Columbia River Basin

RECEIVED

FEB 25 1991

COLUMBIA RIVER INTER-  
TRIBAL FISH COMMISSION  
PORTLAND, OREGON

JOSEPH R. BLUM  
Director



STATE OF WASHINGTON  
DEPARTMENT OF FISHERIES

115 General Administration Building, M.S. AX-11 • Olympia, Washington 98504 • (206) 753-6600 • (SCAN) 234-6600

May 13, 1991

RECEIVED

Mr. Ted Strong, Executive Director  
Columbia River Inter-Tribal Fish Commission  
975 S.E. Sandy Blvd., Suite 202  
Portland, Oregon 97214

MAY 28 1991

COLUMBIA RIVER INTER-  
TRIBAL FISH COMMISSION  
PORTLAND, OREGON

Dear Mr. Strong:

Thank you for your letter regarding the use of salmon smolts as bait for squawfish. The effort to reduce predatory squawfish in the Columbia River is laudatory, but I am unable to provide salmon smolts for this purpose.

As you know, the Washington State Department of Fisheries uses hatchery production to increase the run size of salmon, both for recreational and commercial purposes. In the funding requests for these hatcheries, we specifically identify production goals. The egg take, hatching, and rearing of salmon in our hatcheries are carefully monitored, in order to achieve maximum production with minimal loss of fry or smolts. I believe it would be contrary to the wishes of the Legislature and Fisheries' user groups to utilize hatchery production of salmon, destined for release into fresh and salt water, as bait for squawfish.

I would hope that you can find a bait other than salmon smolts. If you are unable to do so, it appears that the only source for salmon smolts would be a private aquatic farmer. With adequate identification, private sector cultured aquatic products can be held at convenient locations and distributed to your fishers on an as-needed basis.

I wish you success in your effort to reduce the squawfish population.

Sincerely,

*for* Judith Merchant, Deputy  
Joseph R. Blum  
Director

JRB:esj

JOSEPH R. BLUM  
Director



STATE OF WASHINGTON  
DEPARTMENT OF FISHERIES

115 General Administration Building . Olympia, Washington 98504 . (206) 753-6600 . (SCAN) 234-6600

March 1, 1991

RECEIVED

MAR 04 1991.

Mr. Roy E. **Beaty**, Fishery Scientist  
Columbia River Inter-Tribal Fish Commission  
975 S.E. Sandy Boulevard, Suite 202  
Portland, OR 97214 .

COLUMBIA RIVER INTER-  
TRIBAL FISH COMMISSION  
PORTLAND, OREGON

Re: Use of Juvenile Salmonids as Squawfish Bait

Dear Mr. Beaty,

Thank you for your letter regarding the use of dead juvenile salmonids (smolts) as bait to take squawfish. On behalf of the Columbia River Inter-Tribal Fish Commission (Inter-Tribe), you have asked several questions regarding obtaining such bait. The answers to these question appear to depend, **almost** entirely, upon the source of the bait.

In addition to the distinction between **gamefish** smolts (trout, char, etc.), and food fish smolts (Pacific and Atlantic salmon), there is a major distinction between publicly and privately raised fish. This distinction lies in the fact that privately raised **smolts**, whether they be food fish or **gamefish** and notwithstanding whether they come from tribal or non-tribal facilities, are private sector cultured aquatic products. RCW 15.85.020. Private sector cultured aquatic products are **not** regulated by either Fisheries or Wildlife. The only requirement for a person possessing private sector cultured aquatic products is a labeling requirement. RCW 15.85.060.<sup>1</sup>

This is a critical point. If the smolts are obtained from an aquatic farmer, the **only** requirement for use is that the bait, during both shipment from the production facility and at the point of retail sale or distribution, be labeled as private sector

---

<sup>1</sup>The hearing to establish the rules for labeling private sector cultured aquatic products will be held March 13, 1991. See WSR 91-04-076 (attached).

Roy E. Beaty  
2/27/91 - p.2

cultured aquatic products. No other **license** or permit is required from Washington State.

There is a distinction between distribution of **smolts** from a state **gamefish** hatchery and smolts from a state food fish hatchery. This distinction lies in the statutory prohibition against the sale of "wildlife," defined as, "**(A)ll** species of the animal kingdom whose members exist in Washington in a wild state." RCW 77.08.010(16). Although there are exemptions to this prohibition, RCW 77.16.040<sup>2</sup>, I am unable to find any rule that would allow the sale of **gamefish** smolts from a Washington State Department of Wildlife hatchery for use as squawfish bait. Apparently this statutory prohibition also applies to **gamefish** smolts obtained from an Oregon State Department of Fish and Wildlife hatchery; the smolts would, in all likelihood be of, "**a** species whose members exist in Washington in a wild state."

Sale of dead smolts from a Fisheries hatchery, and subsequent resale to fishers, is permissible, provided that **the** purchaser has a Washington State wholesale fish dealers license.<sup>3</sup> Such a license is needed for a business in the state to engage the commercial processing of food fish, engage in wholesale selling, or engage in the commercial manufacture or preparation of fish bait. RCW 75.28.300.'

To obtain a wholesale dealers license, the applicant must pay the license fee of \$100, RCW 75.28.300, and post a performance bond

---

<sup>2</sup>"Except as authorized by law or rule, it is unlawful to bring into this state, offer for sale, sell, possess, exchange, **buy**, transport or ship wildlife..." (emphasis added). Under this statute, **gamefish** smolts could not be used even if they were given away: there may be some overbreadth problems here.

<sup>3</sup>Availability of dead salmon smolts would be highly limited, however. Large numbers would occur only through a catastrophic fault at a hatchery.

'Whether Inter-Tribe could be accurately described as a "business in the state" is questionable, but if not, then the retail outlet from which the bait is sold would need a wholesale dealers license. If Inter-Tribe has a wholesale license, the bait sellers would not need a license, because there is an exemption from licensing for, "businesses which **buy** exclusively from Washington licensed wholesale dealers (ie. Inter-Tribe) and sell solely at retail." RCW 75.28.300(2).'

Roy E. Beaty  
2/27/91 - p.3

of \$2,000, RCW 75.08.323. The performance bond is to ensure that the product being dealt with is accurately reported. Reporting in this instance is simplified, as no fish ticket receiving ticket would be needed. Instead, the hatchery manager would release the dead smolts to Inter-Tribe, and complete a "Carcass and Egg Reporting Form."

There is a possible exemption to a requirement for a wholesale dealers license. If Inter-Tribe is a public entity, and the Director of Fisheries agrees, smolts could be released to Inter-Tribe without cost. A subsequent distribution to fishers without any costs would exempt such bait from being a commercial activity. (recall, a wholesale dealers license is required for "commercial manufacture or preparation"). \*'Commercial' is defined as "related to or connected with buying, selling or bartering." RCW 75.08.011 (15). Absent buying, selling or bartering, there is no commercial activity, and thus no license requirement.

Individual Indian tribes are considered to be public entities, and the Washington Supreme Court has held that distribution of fish to public entities does not violate Art. 8, §5 of the Washington State constitution. Anderson v. O'Brien, 84 Wn.2d 64, 524 P.2d 390 (1974). If Inter-Tribe is not a public entity, a nominal fee must be charged, which triggers the "commercial" activity and requires a wholesale dealers license.

A scientific collectors permit issued by Fisheries is an inappropriate mechanism. Scientific collectors permits are for "handling, collection, or release of food fish or shellfish." WAC 220-20-045. Food fish includes only those species classified by the Director of Fisheries. RCW 75.08.080(1)(h). Squawfish are not a food fish (nor are they a gamefish; they are "wildlife").

Whether or not a wholesale dealers license is required, the state would want some method, at the fishing site, of accounting for the origin of the smolts being used as squawfish bait. This determination is basic to the program; both Fisheries and wildlife would be very concerned if the source of the bait could not be established. For example, if an unscrupulous fisher finds that smolts are superb bait, but is frustrated in an attempt to obtain additional bait, a minnow seine or a quarter-stick of dynamite are excellent procurement methods. Accordingly, we would ask, first, that the bait be released to the fishers at nominal or no cost (perhaps a fee could be paid directly to the store owner holding the bait, thus eliminating the fisher having to pay for the bait: a handling fee paid to the store owner for the storage of the bait

Roy E. Beaty  
2/27/91 - p.4

would probably not trigger "commercial" activity). Second, we would ask the bait be packaged in some method that it is readily identifiable. Compliance with these two requests would reduce the anxiety level of our fish managers.

In conclusion, the easiest and least restrictive method of obtaining and using juvenile salmonids for squawfish bait would be to obtain them from private sector aquatic farmers. The only requirement for distribution and use of such bait would be proper labeling. Increasing in complexity would be use of salmon smolts from Fisheries hatcheries, unless Inter-Tribe was a public entity, while use of ganefish smolts from a Wildlife hatchery is prohibited.

If you have any questions, please do not hesitate to call me.

Sincerely,

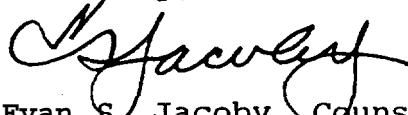

Evan S. Jacoby, Counsel  
Fisheries Legal Services

cc: Director Blun  
R. Costello, Sr. AAG  
M. Jelvik, Fisheries  
D. Matthews, Fisheries  
K. Martinson, Fisheries  
J. Neal, Wildlife  
H. Small, Fisheries

for a period of no more than six months after date of issuance.

#### NEW SECTION

**WAC 308-125-140 PASSING EXAM SCORE.** A minimum scaled score of seventy is required to pass the state-certified real estate appraiser examination.

#### NEW SECTION

**WAC 308-125-150 EXAMINATION PROCEDURES.** (1) Each applicant will be required to present one piece of positive identification which bears a photograph of the applicant. In the event the applicant has no photo identification, the applicant will be required to make prior arrangements with the licensing unit not later than ten working days prior to the examination. Failure to produce the required identification will result in the applicant being refused admission to the examination.

(2) Applicants will be required to refrain from talking to other examinees during the examination unless specifically directed or permitted to do so by a test monitor. Any applicant observed talking or attempting to give or receive information, using unauthorized materials during any portion of the examination, or removing test booklets and/or notes from the testing room will be subject to denial of a certification.

(3) Applicants who participate in disruptive behavior during the examination will be required to turn in their test materials to the test monitor and leave the examination site. Their opportunity to sit for the examination will be forfeited. Their answer sheet will be voided. A voided answer sheet will not be scored and the examination fee will not be refunded. A candidate must then reapply to take the examination.

#### NEW SECTION

**WAC 308-125-160 WAIVER UNDER RCW 18.140.080.** The director will not waive clock hour requirements as provided in RCW 18.140.080(3).

#### NEW SECTION

**WAC 308-125-170 EXCEPTIONS TO CHAPTER 18.140 RCW.** No exceptions will be allowed to the requirements of chapter 18.140 RCW except as provided by statute or rule.

#### NEW SECTION

**WAC 308-125-180 RECIPROCITY.** A person licensed or certified as a real estate appraiser under the rules or laws of another state may obtain certification in the state of Washington when the following condition is met:

The state in which the appraiser is licensed or certified has an appraiser licensure or certification program which meets federal guidelines and the state has a written reciprocal agreement with the state of Washington.

A person seeking certification under this section must provide a notarized statement from the state in which

the person is licensed or certified establishing licensure or certification.

#### NEW SECTION

**WAC 308-125-190 EXAMINATION REQUIRED-SCOPE.** The director shall approve an examination for certification of real estate appraisers. This examination may be prepared and administered within a state agency, or the director may request bids for contracts to prepare and administer the exam. Such requests for proposals shall be done in accordance with the state law.

(1) The director will determine the scope of the examination and provide information concerning the scope of the examination to an individual upon request.

(2) If the director determines to seek proposals for testing services, the director will establish criteria for evaluating the proposals.

#### NEW SECTION

**WAC 308-125-200 STANDARDS OF PRACTICE.** The standard of practice governing real estate appraisal activities will be the Uniform Standards of Professional Appraisal Practice of the Appraisal Foundation.

#### NEW SECTION

**WAC 308-125-210 REQUIRED RECORDS—ACCESSIBILITY OF RECORDS TO THE DEPARTMENT OF LICENSING.** All certified appraisers certified under chapter 18.140 RCW must retain records required by the Uniform Standards of Professional Appraisal Practice for a minimum of five years. Such records will be subject to random audit by the department without notice and must be readily available for inspection by a representative of the department.

#### WS R 9 1-04-075

#### NOTICE OF PUBLIC MEETINGS TRANSPORTATION COMMISSION (Memorandum-February 5, 1991)

The March Washington State Transportation Commission public meeting will be held on Wednesday, March 13, 1991, at 9 a.m. There will be no public meeting on March 12, 1991. The location for the March meeting is: Olympia, Washington, Transportation Building, Conference Room 1D2.

#### WSR 9 1-04-076

#### PROPOSED RULES DEPARTMENT OF AGRICULTURE [Filed February 6, 1991, 9:54 a.m.]

#### Original Notice

Title of Rule: Aquaculture identification requirements.

**Purpose:** To adopt rules that would require that aquatic farm products be identified and labeled.

**Statutory Authority for Adoption:** RCW 15.85.040 and 15.85.060.

**Statute Being Implemented:** Chapter 15.85 RCW.

**Summary:** Requires that any sale or movement of private sector cultured aquatic products made by an aquatic farmer be accompanied by a shipping document and be properly labeled.

**Reasons Supporting Proposal:** There is a need to identify commercially-caught fisheries products from a farmed product. Wild-caught fish need to be identified from farmed fish.

**Name of Agency Personnel Responsible for Drafting and Implementation:** John Pitts, 406 General Administration Building, Olympia, 586-2777. *W 14*

**Name of Proponent:** Washington State Departments of Agriculture, Fisheries and Wildlife, governmental.

**Agency Comments or Recommendations, if any, as to Statutory Language, Implementation, Enforcement, and Fiscal Matters:** This rule contains no enforcement provisions and will depend on voluntary compliance.

Rule is not necessitated by federal law, federal or state court decision.

**Explanation of Rule, its Purpose, and Anticipated Effects:** The purpose of the rule is to be able to follow the product from the farm to the marketplace and to have it identified as a farmed product to allow fisheries officers of the Department of Fisheries to identify it and separate it from wild-capture fisheries, which would be identified in another manner. The rule is also necessary in order to identify a farmed fish from a poached fish which may be being transported illegally.

Proposal does not change existing rules.

No small business economic impact statement is required for this proposal by chapter 19.85 RCW.

**Hearing Location:** Washington State Department of Agriculture, Market Development Division, 6120 Capitol Boulevard, Tumwater, WA, on March 13, 1991, at 7:00 p.m.

**Submit Written Comments to:** John Pitts, by March 13, 1991.

**Date of Intended Adoption:** April 15, 1991.

February 5, 1991

Arthur C. Scheunemann  
Assistant Director

#### Chapter 16-603 WAC

#### AQUACULTURE IDENTIFICATION REQUIREMENTS

##### NEW SECTION

WAC 16-603-010 AQUACULTURE IDENTIFICATION REQUIREMENTS. (1) Any sale or movement of private sector cultured aquatic products made by an aquatic farmer, other than retail sale for personal use by the purchaser, shall:

(a) Be accompanied by a shipping document showing

(i) The aquatic farmer's name;

(ii) The aquatic farm mailing address;

(iii) The aquatic farm registration number;

(iv) The date of sale or transfer by the aquatic farmer;

(v) The quantity of each species; and

(b) Be labeled, showing the name of the aquatic farmer and the farmer's aquatic farm registration number on each container of cultured aquatic products

(c) The shipping documents and labeling required under this section shall be retained and maintained by the purchaser while the private sector cultured aquatic products are under the purchaser's possession or control

(2) The provisions of this section do not apply to shellfish if the shellfish comply with rules enacted under the labeling requirements for the Sanitary Control of Shellfish Act (WAC 248-58-070).

#### WSR 91-04-077

PROPOSED RULES

DEPARTMENT OF

LABOR AND INDUSTRIES

[Order 91-01—Filed February 6, 1991, 10:39 a.m.]

#### Original Notice.

**Title of Rule:** Chapter 296-24 WAC, General Safety and health standards; chapter 296-56 WAC, Safety standards for longshore, stevedore, and related waterfront operations; chapter 296-62 WAC, General occupational health standards; chapter 296-99 WAC, Safety standards for grain handling facilities; chapter 296-155 WAC, Safety standards for construction work; chapter 296-305 WAC, Safety standards for fire fighters; and chapter 296-306 WAC, Safety standards for agriculture code.

**Purpose:** Chapter 296-24 WAC, the purposes of the proposed federal-initiated amendments to this chapter are to make the existing state standards in Part A-4 at-least-as effective-as the federal final rule and incorporate corrections received in Federal Register Volume 55, Number 183, dated September 20, 1990. These are clarifications and housekeeping amendments to correct federal publication errors. The purpose of the proposed state-initiated amendments is to correct source references and provide a consistent definition of "potable water"; chapter 296-56 WAC, the purpose of the federal-initiated proposed amendment is to prohibit the use of 4 x 29 wire rope in any "running rigging." This proposed amendment is the result of OSHA Hazard Alert STD 2-1.9. The purpose of the state-initiated proposed change is to correct statement relating to running water; chapter 296-62 WAC, the purpose of the state-initiated proposed housekeeping amendments is to correct typographical errors, reflect current ANSI specifics and make narrative identical with federal materials; chapter 296-99 WAC, the purpose of this federal-initiated proposed amendment is to reinstate a 1/8 inch action level for priority housekeeping areas in grain handling facilities. This amendment will make the WISHA standard "Identical" to 29 CFR 1910.272 (i)(2)(ii); chapter 296-155 WAC, the purposes of the federal-initiated proposed amendments are to cancel an exemption from wearing head protection to Old Order Amish and the Sikh Dharama Brotherhood, to delete two items, and add a new definition to be at-least-as effective as the federal rule. These changes are made to make the state standard: at-least-as-effective-as or "identical" [to] the federal rule. The purpose of the state-initiated proposed amendment is to adopt the 1985 edition of ANSI A 10.3, Safety requirements for powder actuated fastening systems. This proposed amendment will allow the use of powder loads regardless of the manufacturer, provided



C ALAN PETTIBONE  
Director



STATE OF WASHINGTON

DEPARTMENT OF AGRICULTURE

406 General Administration Bldg , AX-4 1 . Olympia, Washington 98504-0641 . (206) 753-5063

June 10, 1991

RECEIVED

JUN 13 1991

COLUMBIA RIVER INTER-TRIBAL FISH COMMISSION  
PORTLAND, OREGON

Mr. Roy E. Beaty  
Fishery Scientist  
Columbia River Inter-Tribal Fish Commission  
975 S.E. Sandy Boulevard  
suite 202  
Portland, Oregon 97214

Dear Mr. Beaty:

I am sorry to be so late in responding to your request for information regarding labeling requirements for aquaculture products from Washington state. I have enclosed the revised and final version of the rule which was clarified after a March public hearing. The rule will be signed this month and aquatic farmers will be required to comply on January 1, 1992.

The aquatic farmer will be required to provide specific information when the fish are transported from his/her farm. The requirement for shipping live fish continues to be regulated through the Department of Fisheries. There is no similar requirement for transporting dead fish from public hatcheries.

If you have any questions, please call me at (206) 586-2777.

Sincerely,

MARKET DEVELOPMENT DIVISION

John L. Pitts  
Aquatic Farm Program Manager

JLP:l  
Enclosure

Chapter 16-603 WAC

AQUACULTURE IDENTIFICATION REQUIREMENTS

NEW SECTION

WAC 16-603-010 AQUACULTURE IDENTIFICATION REQUIREMENTS.

(1) Any sale or movement of private sector cultured aquatic products made by an aquatic farmer, other than retail sale for personal use by the purchaser or rendering or unmarketable solid waste disposal, shall:

(a) Be accompanied by a shipping document showing:

(i) The aquatic farmer's name;

(ii) The aquatic farm mailing address;

(iii) The aquatic farm registration number required by RCW 75.58.040;

(iv) The date of transfer by the aquatic farmer;

(v) The quantity of each species; and

(b) Be labeled, showing the name of the aquatic farmer and the farmer's aquatic farm registration number on each container of cultured aquatic products.

(c) The shipping documents and labeling required under this section shall be retained and maintained by the purchaser while the private sector cultured aquatic products are under the purchaser's possession or control.

(2) The provisions of this section do not apply to shellfish if the shellfish comply with rules enacted under the labeling requirements for the Sanitary Control of Shellfish Act (WAC 248-58-070) or to live finfish or their reproductive tissues, if the finfish comply with rules enacted under the Washington Department of Fisheries transfer procedure set forth in Chapter 220-77 WAC.

# Oregon

RECEIVED

MAR 11 1991.

COLUMBIA RIVER INTER-  
TRIBAL FISH COMMISSION  
PORTLAND, OREGON

---

 DEPARTMENT  
 OF FISH AND  
 WILDLIFE
 

---

March 4, 1991

Mr. Roy E. Beaty, Fishery Scientist  
 Columbia River Inter-Tribal  
 Fish Commission  
 975 SE Sandy Blvd., Suite 202  
 Portland, OR 97214



Dear Roy:

I apologize for the lateness of my response to your January 11, 1991, letter.

As I understand your question, the Columbia River Inter-Tribal Fish Commission will obtain dead juvenile salmonids from Oregon hatcheries for use as bait by tribal and CRITFC employees angling for northern squawfish from some main stem Columbia and Snake River dams. These juvenile salmonids will be provided to retail bait dealers for sale to tribal longline fishermen and other end users.

All of our state laws and regulations regarding the use of bait or sale of bait refer to "food fish." Since salmonids under 15 inches are classified as game fish under ORS 496.009, those laws and regulations would not apply to the use of juvenile salmonids.

Roy, it is important that you keep clear records of where the salmonids were obtained and provide a copy of that record to the bait dealer that you sell the bait to. That gives us a clear administrative record of the source and ultimate disposition of those fish. I have no problem with your charging bait dealers a reasonable price for the bait, but we may wish to discuss with our Commission the sale of game fish and develop a regulation which clearly authorizes the use you are intending it for. In the meantime, I believe if you follow the steps I have outlined, you will have satisfactorily met the necessary obligations to sell dead juvenile salmonids to bait dealers.

Sincerely,



Kay Brown  
 Special Assistant  
 Fish Division

bw

c Norm Whitten, Tony Nigro, Ron Boyce, Jim Martin  
 WP



---

 2501 SW First Avenue  
 PO Box 59  
 Portland, OR 97207  
 (503) 229-5400



**IDAHO FISH & GAME**

600 South Walnut / Box 25  
Boise, Idaho 83707

March 6, 1991

RECEIVED

MAR 11 1991.

COLUMBIA RIVER INTER-  
TRIBAL FISH COMMISSION  
PORTLAND, OREGON

Mr. Roy Beaty  
Columbia River Inter-  
Tribal Fish Commission  
975 S.E. Sandy Blvd. Suite, 202  
Portland, Oregon 97214

Dear Mr. Beaty:

To confirm your earlier conversation with Al Van Vooren, the Department will not endorse or sanction the distribution of juvenile salmonids for bait through retail bait dealers or through CRITFC directly.

Our reasons for this are the legality, enforcement concerns, disease transmission concerns, and the ready availability of alternate baits through wholesale markets.

Sincerely,

Steven M. Huffaker, Chief  
Bureau of Fisheries

SMH: jb

Cecil D. Andrus / Governor  
Jerry M. Conley / Director





REPORT D

EVALUATION OF HARVEST TECHNOLOGY  
FOR SQUAWFISH IN **COLUMBIA RIVER RESERVOIRS**

ANNUAL REPORT, **1991**

Bonneville Power Administration  
Project 90-077

Prepared by  
S. B. Mathews, T. K. Iverson, J. M. Lynch,  
B. D. Mahoney, and R. W. Tyler

Center for Quantitative Science

November, **1991**



TABLE OF CONTENTS

	<u>Page</u>
INTRODUCTION .....	<b>191</b>
REPORT 1- .....	<b>193</b>
Transfer of <b>longline</b> technology to a tribal reward fishery for northern squawfish.	
REPORT 2- .....	201
Purse seining.	
REPORT 3- .....	209
Merwin trapping as a control technique for northern squawfish populations.	
GENERAL SUMMARY .....	<b>230</b>





## INTRODUCTION

During **1991**, the University of Washington was responsible for evaluating three different methods of removing northern squawfish (*Ptychocheilus oregonensis*) from Columbia River reservoirs. These three gear types, longlining, purse seining, and Merwin trapping, are very diverse in their method of operation and their subsequent success of capture, and therefore have been evaluated within individual chapters of this report.

A **longline** fishery using the UW **longline** system on board tribal commercial fishing boats, was conducted in a limited fashion in **1990** and was expanded to a full scale removal fishery for this year, **1991**. Our responsibility for this fishery was to transfer our knowledge of the **longline** gear to the participating tribal fishermen and determine whether or not they were effective at fishing this type of gear.

The second method of removal that was attempted this year is purse seining. Our seining efforts in **1990** were on a limited schedule during early Fall and this may have been the cause of our low catch rates. This year we attempted purse seining during the months of May and June while the northern squawfish are forming spawning schools and/or exhibiting a migrational behavior which might increase their susceptibility to the purse seine.

Finally we fished Merwin traps for large-scale squawfish removal. This method has been shown in the past to be extremely effective, and we felt it should be tried again. Once the several reward fisheries have removed a bulk of the northern squawfish from the Columbia River, an agency operated control device may be necessary for maintaining a removal effort well into the future.



REPORT 1:  
TRANSFER OF **LONGLINE** TECHNOLOGY  
TO A TRIBAL REWARD FISHERY FOR NORTHERN SQUAWFISH

In 1989 the University of Washington was charged with the task of developing a gear for use on the Columbia River to target northern squawfish (*Ptychocheilus oregonensis*) (Mathews et al. 1990). The gear was to be used in a tribal fishery and designed to be easily deployed from boats traditionally fishing on the river. In 1989, we tested many gear types and determined that a lightweight monofilament longlining system was the most efficient. This relatively inexpensive type of gear caught the greatest number of northern squawfish while catching the lowest number of other species. Also, we discovered that incidental fish could be removed from the **longline** with very low probability of damage or mortality.

In 1990 ODFW conducted a test fishery which employed three tribal commercial fishermen and used the **longline** system we had developed for targeting squawfish (Mathews and Iverson, 1991). The results of this test fishery were questionable, yet promising. Catch rates were generally low, however, it was felt that the amount of restriction placed on the fishery limited the fishermen's ability to harvest maximum numbers of squawfish.

This year, 1991, ODFW implemented a full-scale tribal reward fishery for northern squawfish. All tribal members that applied, and had a boat of sufficient size for safe operation while carrying an ODFW observer, were to receive a packet of **longline** gear and be paid a reward of \$4 per squawfish. Our responsibilities for this tribal fishery included recommending a set of regulations for this fishery, advertising the fishery, selecting the tribal fishermen that would participate in the program, providing a start up packet of **longline** gear to each participant, and providing any needed advice or assistance to participating fishermen. We also assisted Columbia River Inter-tribal Fisheries Commission (CRITFC) in acquiring and distributing bait for use by the tribal fishermen participating in this fishery.

METHODS

Fishery Regulations

Our first responsibility was to provide a recommended set of regulations for this full scale reward fishery. Our recommendations for the regulations on this fishery were based on our experience with the 1990 tribal **longline** fishery for northern squawfish. We wanted the fishing regime as unrestrictive as possible, yet devoid of potential conflicts between tribal fishermen and other user groups on the Columbia River. Our other primary concern was that this fishery should target northern squawfish with a minimal impact on incidentally caught, non-targeted fish species.

Our recommendations were as follows:

1) Fishing should occur on Monday through Friday from May 1 to September 30, 1991. Our main concern was to keep conflicts with other river user groups

at a minimum by fishing only during the week; the fishermen also suggested that they would prefer to have weekends off for tribal functions. It was evident that fishing did not start early enough in 1990 and therefore, the 1991 fishing season needed to be extended to earlier in the year.

2) Baited longlines should fish for no more than 36 hours before retrieving. We wanted to insure that any non-squawfish could be released in a timely fashion, thus reducing mortality on incidental species.

3) All longline groundlines should be restricted to a maximum of 1,200 feet in length and marked every 600 feet with buoys that would be clearly visible on the surface of the river and easily identified as tribal longline markers. This regulation would insure that tribal squawfish longlines would be easily recognizable by other river users and by fishery enforcement agencies. Also groundlines would be short to minimize probability of interference with other users of the river.

4) Only size 3/0 fishing hooks, non-stainless steel, should be used in this fishery and the maximum breaking strength of the gangion leaders should be 30-lb. test. We found that smaller hooks tend to be swallowed by most fish species, thus increasing the rate of mortality of non-targeted fish. Leader strength greater than 30 lb. tends to hold larger sturgeon or other important game fish.

5) Participants in this fishery should be required to keep a daily log book (provided by ODFW/UW). Specific information on each longline set should be recorded and turned in with each day's catch. In this way incidental catch information could be closely watched in order to determine the effect of this fishery on non-squawfish species. Also, the efficiency of the tribal longline fishermen could then be evaluated to determine the effectiveness of the longline fishery.

6) Fishery observers should be used again in 1991 to insure the quality of the data that is being reported and to monitor the impact of this fishery on incidental fish.

These recommendations were given to ODFW early in 1991 to give that agency time to modify and adjust them into an enforceable set of rules.

We also recommended that a start up kit of longline gear should be provided along with a manual on how to operate the gear. We didn't feel that the past catch rates were high enough to encourage fishermen to invest in this new fishery.

#### Selection of Fishers

It was our responsibility to advertise and recruit tribal commercial fishermen into this fishery. A problem discovered in the 1990 trial fishery was that the fishery was not announced to the potential participants until late in the year. Many of them had acquired other jobs and could not participate in that fishery. Therefore, this year we sent an initial announcement letter to all potential fishermen in early February, 1991 (Appendix 1.1). CRITFC provided a mailing list of nearly 400 names of potential tribal commercial fishermen. We sent each a letter, and we

additionally sent 25 letters to each of the participating tribes' fisheries management offices for distribution. In total, over 500 announcement letters for this fishery were mailed in early February. This letter outlined the general regulations of the fishery, what would be expected of the fishermen, and how the fishery would operate. Along with this letter was both a UW phone number to call for any questions and a questionnaire to be filled out by any interested fisherman.

The deadline for sending in questionnaires was stated as March 1 so we could order gear for all interested fishermen in a timely fashion. We hoped to have three weeks to acquire the necessary fishing gear and another week to put the gear into packages for the fishermen. We could then provide the gear to the fishermen in ample time for them to be ready to fish by May 1, 1991.

A meeting was planned for the last weekend in April to introduce the agency personnel that were involved in the program and to meet the participating fishermen face to face. We also hoped to be able to distribute all of the fishing gear at this meeting.

#### Calendar of Events 1991

February 5	Announcement letter was sent to over 500 potential fishermen.
March 1	Questionnaire due in order to receive free gear package.
April 6	Mailed letter announcing fisher's meeting.
April 27	Fisher's meeting in The Dalles, OR.
May 1	Fishery opens.
May 23	Mailed a revised letter to each of the four tribes announcing the expansion of the fishery and that all interested fishermen would receive a packet of gear.
June 12	Expansion into The Dalles and John Day pools.
August 15	In-season progress report from fishermen.
September 30	Fishery ends.

#### Description of Gear Packets

Because this was a brand new fishery, we were concerned that any **significant** start up costs might deter **potential** fishermen from participating in this reward fishery and therefore, gear packets were to be provided to all fishermen that wished to participate in the program.

The gear packets provided most, but not all, of the necessary gear for fishing the UW designed monofilament **longline** system for northern squawfish. Each packet included:

1	Manual <b>longline</b> reel
7	Replacement spools for manual <b>longline</b> reel
14	Lengths, 600 feet long, of 300 lb. test monofilament groundline
1000	3/0 Kahle horizontal fishing hooks
750	Plastic one-piece <b>gangion</b> snaps
1000	Plastic beads for <b>gangion</b> snaps
750	Feet of 30 lb. test monofilament line for leaders

- 20 Hookboards with holders
- 50 Large Sea-Dog carabinier snaps
- 30 Small Sea-Dog carabinier snaps
- 50 Halibut **gangion** snaps for anchors
- 1 Crimping tool and 200 line sleeves
- 2 Cans of **florescent** spray paint for buoys
- 1 **Longline** manual.

The total cost of each gear packet was roughly \$1,800. For a more detailed description of this gear, see Appendix 1.2.

After receiving this gear, the fishermen then had to provide anchors, buoys, and buoy lines. Also, they had to install the **longline** reel in their boat and spend a substantial number of hours preparing the gear for fishing. This included tying hooks and gangions, and rigging buoys, anchors, and buoy lines so they could all be integrated into this **longline** system. The total cost to each fisherman for this portion of the gear we estimated at less than \$300. Of course this amount probably varied depending on materials purchased and the specific method chosen for deploying the gear.

Enough gear was provided to allow each fisherman to set and retrieve as many as fourteen 600-foot units of groundline. This would allow the fishermen to fish well over 500 hooks per day if they were so inclined.

#### Interaction With Fishermen

A major emphasis for this year was to give the fishermen as much freedom as possible in setting up their gear. To help facilitate this, we developed a **longline** manual describing all aspects of the fishery (Appendix 1.2). It displayed how we had fished the gear in the past and how we set up the **longline** system. We made a special point to emphasize that there are many ways to fish longlines for squawfish, and our way is only one of them.

We also wanted the fishermen to know that we were available for assistance throughout the fishery. We arranged for a meeting in April in order to introduce all of the agency personnel to the fishermen and for the fishermen to meet one another. We also described all of the gear being provided to the fishermen so that they would understand how the assembly worked. Because this is a new gear for them, we felt that we should have a phone number they could call for ongoing information, suggestions, and advice on how to better fish this gear. We arranged a hotline number for them to call that reached our field station.

#### Bait

It was readily apparent at the beginning of the season that the cost of bait procurement could be major deterrent to participating fishermen. To overcome this obstacle, we agreed to assist Columbia River Inter-tribal Fisheries Commission in obtaining bait-sized smolts from two hatcheries: a private grower, Dom-Sea Farms in Rochester Washington and a public facility, Warm Springs National Fish Hatchery in central Oregon. The smolts were processed as described in our 1990 report; salting them as they were removed from the raceways at the hatchery, drained for two days, and then packaged in small lots and placed in a chest freezer provided by OSU. The bait was given

to any tribal fisherman that requested it from us or from ODFW fishery observers.

### UW Test Fishing

We had planned to fish longlines in the McNary **tailrace** every other week in order to provide a baseline for assessing how well the fishermen were doing in the reward fishery. We also wanted to keep a continuous record of **longline** CPUE from the McNary **tailrace** which we have fished for the past two years. Unfortunately, due to the high flows, spilling occurred at McNary Dam daily through the middle of July. We were unable to fish at this location until the last week of July and the second and fourth weeks of August.

## RESULTS

Our recommendations for the **longline** fishery regulations were generally accepted as they were written. The fishing days during the week were changed to Wednesday through Sunday due to a request by some tribal members. Apparently some fishermen wanted to fish longlines only on the weekends as a supplement to their weekday, full-time employment.

Interest in the **longline** fishery was extremely low at first. We received only six questionnaires from interested fishermen by the March 1 deadline. We therefore continued to accept questionnaires through April 1 and at that time ordered the major components of the gear packets. The number of interested fishermen had increased to 10, so we ordered 10 sets of gear at that time. Questionnaires continued to trickle in throughout most of the summer (Table **1.1**). By the middle of May we had received an additional 10 questionnaires; therefore, we ordered more sets of gear to accommodate any additional fishermen that showed interest in this fishery. By the middle of July a total of 30 fishermen mailed or called expressing interest in the tribal reward **longline** fishery.

Table **1.1** Number of applications received by month for the tribal **longline** reward fishery.

Questionnaires	
Month	Returned
February	5
March	5
April	9
<b>May</b>	4
June	<b>5</b>
<b>July</b>	<b>2</b>
Total	30



Of the 30 fishermen that signed up for the fishery, 15 received a gear package, 10 never made arrangements to receive their gear even though there was a gear package available for them, and five fishermen either did not own a boat or were not interested in the fishery once they learned more about how it operated.

Of the 15 fishermen that were issued gear packets, 8 fishermen actually went fishing; they set one or more longlines. One other fisherman chose not to use our gear but fished hand longlines that he constructed himself. This made a total of 9 fishermen participating in the reward program.

A total of 1,071 northern squawfish were caught in the tribal longline reward fishery. Five fishermen were responsible for 92% of the catch. One fisherman captured over 37% of the total squawfish catch.

Northern squawfish composed roughly 66% of the total catch. White sturgeon (*Acipenser transmontanus*) was the highest caught incidental species at 22% of the total catch with channel catfish (*Ictalurus punctatus*) at roughly 6%. All other species composed 6% of the total catch for the longline reward fishery.

In August we performed a survey of participating fishermen to find out what they thought about the fishery and the gear that was supplied to them (Appendix 1.3). Twelve fishermen were contacted for this in-season progress report. Most of the comments were quite positive.

Most fishermen felt that the amount of gear and the type of gear was adequate to capture significant amounts of squawfish. The level of interaction by UW was also to a degree that was satisfying to the fishermen. The amount of reward was sufficient to hold the interest of the fishermen.

The main problem that the fishermen faced was with their daily expenses. Purchasing gasoline for their boats and other daily expenses proved to be the greatest barrier to the success of this program. Almost all of the fishermen that responded to the in-season progress report stated that if they had been reimbursed for daily expenses in some way, they would have fished more often and more intensively.

The second problem that the fishermen raised was the perception of being under extreme scrutiny by the ODFW observers. The amount of paperwork required for each day of fishing, along with the daily presence of ODFW employees was intimidating to many fishermen. Because of such low participation in this program, there was essentially an observer prepared to survey nearly every trip by each fisherman. Some fishermen mistook this research effort by ODFW as an effort to police the fishery.

There was a wide range of other comments. Many fishermen would like to have fished Monday through Friday so as to have the weekends off. Some fishermen felt that UW should have provided other baits because they did not like the salted salmon smolts. Most of the fishermen felt that the longline was the proper method for removing squawfish. A few would like to have tried baited pots and traps.

## DISCUSSION

It is difficult to assess the success of this fishery. The participation was disappointing and the total catch was not very great. The interest among the tribal fishermen appeared to be much lower than we anticipated. We expected to see 30 fishermen participating in the program this year as diligently as the 9 fishermen that actually fished.

Of the fishermen that participated this year, their interest in the fishery was higher than what their actions showed. Even while discussing the in-season progress report with them, less than 4 fishermen were still fishing, and yet all of the fishermen we talked to stated that the program was great, the bounty was favorable, the **longline** system was commendable, the assistance from all agencies was satisfactory. Yet no one was out fishing.

After speaking with the fishermen, and with OOFW, we decided that the only way this fishery could be successful is by some how supplying daily expenses for these fishermen. Because it is a new fishery, they apparently do not want to take the risk in learning how to capture squawfish. They were easily discouraged by low catch rates and were not very creative in their fishing techniques.

The **longline** manual was helpful in getting the fishermen started. It allowed the fishermen to gear up on their own with relatively little input from us, which seemed to be important to these fishermen. It proved to be a very constructive tool in transferring the **longline** technology to the fishermen.

One noticeable trend was that this year's fishermen had a much higher rate of incidental catch than our previous years testing indicated. This is because they normally fished their lines directly on the bottom, in contrast to previous test efforts, which increased their chances of catching sturgeon. Our test fishermen in 1990 usually fished their lines from surface to bottom, covering all of the water column, fishing fewer hooks directly on bottom, and thus tending to catch a lower percentage of sturgeon.

Many new baits were also tried this year. These included prawns, lures, rubber worms, shad meat, salmon guts, and other unique items. The overall catch rates weren't high enough to conclude which, if any, of these baits worked better than salted salmon smolts. The fact that the fishermen kept trying alternative baits and not the bait provided by UW/CRITFC, indicates they were attempting to be creative, which is laudable. Although we previously found smolts to be the most effective bait, we by no means tested all possibilities.



REPORT 2:  
PURSE SEINING

In 1989 we experimented with a small boat purse seine for capturing northern squawfish, *Ptychocheilus oregonensis* (Mathews et al. 1990). Because squawfish tend to form large schools near the hydroelectric projects on the Columbia River, we felt that this would be a productive fishing method. We had very low catch rates of northern squawfish but also a very limited amount of effort. We decided to try purse seining again in 1990 with a chartered commercial herring purse seiner (Mathews and Iverson 1991). By chartering an experienced, knowledgeable, commercial fishermen with a boat and large purse seine we hoped to improve our catch rates. Again our success rate on squawfish was minimal during the 10 days we fished during the month of September.

We concluded in 1990 that we were fishing at the wrong time of the year to capture large schools of northern squawfish. We felt that our technique was adequate and that if there were squawfish in the area, we would catch them. In 1991 we again chartered the purse seiner who worked with us in 1990 and focused our fishing effort in May and June when the squawfish might tend to school and migrate in large numbers associated with spawning. We felt that if purse seining were to be effective, it would have to be correlated with the spawning activities of the northern squawfish.

Our goal for this year was to target a few potential squawfish spawning locations with advice from U.S. Fish and Wildlife Service (USFWS). USFWS has larval sampling experience and maps which provided an indication of locations with likely spawning substrate for northern squawfish. We also planned to intensively fish at and around The Dalles Dam hoping to intercept migrating schools of ripening squawfish. The Dalles Dam has had the largest historical average of northern squawfish ladder passage since 1957 (Table 2.1).

## METHODS

### Description of The Purse Seine Nets

**NET #1.** This net was originally designed to be deployed from a power drum aboard a 21-foot boat. It was used in both the 1989 and 1990 purse seine test fishing (Mathews et al. 1990, Mathews and Iverson 1991). In 1991 the net was modified to improve its use in shallow water and was deployed from a power block aboard a 36-foot purse seine boat.

Modifications to **NET #1** entailed reducing the pursed length from  $3/4$  to  $1/2$  the length of the net; enlarging the purse rings from **3"** to **6"**; lengthening the ring bridles and reducing their number from 30 to 15; increasing the weight of the **leadline** from 3 to 6 lbs. per fathom; increasing the flotation of the **corkline** by doubling the number of corks; moving the purse line from the bottom of the selvage to the top. The net measured 350 feet long, 25 feet deep and was hung with  $2\ 1/2"$  by 15 gauge knotted nylon web.

Table 2.1 SUMMARY OF ANNUAL FISH PASSAGE REPORTS

<b>Squawfish Counts over Columbia River Dams</b>				
<b>Year</b>	<b>Bonneville</b>	<b>The Dalles</b>	<b>John Day</b>	<b>McNary</b>
1938	57542	NA	NA	NA
1939	64396	NA	NA	NA
1940	59780	NA	NA	NA
1941	42063	NA	NA	NA
1942	43818	NA	NA	NA
1943	42507	NA	NA	NA
1944	51979	NA	NA	NA
1945	52933	NA	NA	NA
1946	90733	NA	NA	NA
1947	91761	NA	NA	NA
1948	38735	NA	NA	NA
1949	45027	NA	NA	NA
1950	37140	NA	NA	NA
1951	39451	NA	NA	NA
1952	28397	NA	NA	NA
1953	67202	NA	NA	NA
1954	43700	NA	NA	47826
1955	41077	NA	NA	57355
1956	39080	NA	NA	16739
1957	19157	103487	NA	7041
1958	19173	108032	NA	7358
1959	27963	81607	NA	7255
1960	21907	89237	NA	6428
1961	13213	95433	NA	6532
1962	11079	81189	NA	8869
1963	10385	91656	NA	10409
1964	9356	74358	NA	4521
1965	9985	51699	NA	4673
1966	11504	58685	NA	6784
1967	9411	68687	NA	4621
1968	19605	99513	123044	5541
1969	23853	63627	101743	10602
1970	NA	NA	NA	NA
1974	NA	NA	NA	NA
1975	NA	22630	44246	4834
1976	NA	26315	31503	13107
1977	NA	NA	NA	17662
1990	22908	83375	25464	8612
<b>Yearly Avg:</b>	<b>36570</b>	<b>74971</b>	<b>65200</b>	<b>12838</b>

From U. S. Army Corp of Engineers  
 Portland and Walla Walla Districts. (1938-1990)

NET #2. This net measured 400 feet long by 35 feet deep; the purse line was hung on top of the selvage; the **leadline** weighed 8 lbs. per fathom; the mesh was 2 1/2" by 12 gauge knotted nylon; the net was half pursed.

#### Deployment of The Purse Seine Nets

Purse seining was done primarily along the shorelines where water currents were less than 0.5 f.p.s. and where soundings of the bottom showed relatively smooth, snag-free substrate. The nets **were used** extensively in The Dalles Dam **forebay** along the face of the spillway during non-spill period. Numerous sets were also made in the cul-de-sac of The Dalles Dam (Plate 2.1). Additional sets were made in the upstream and downstream lock entrance channels and approaches. Only a few sets were made in the deep, fast flowing water of mid channel due to the unlikelihood of finding northern squawfish there.

The nets were generally set close to the shore, on the bottom, in water as shallow as 10 feet. The nets were retrieved by slowly moving the boat backwards along the net assisted by the seine skiff. Hauling in the lead of the net was usually accomplished without snagging. Snags were more often encountered during pursing as the lead line was gathered together on the river bottom.

The purse seine sets were generally round-hauled but sets were occasionally held open for 10 minutes to test whether squawfish accumulated in the net. Holding the net open did not affect the catch of squawfish, but may have increased the catch of salmonids and shad.

In block-seining, the net was pursed from the bunt end while the net lead was being hauled aboard. Simultaneous pursing and hauling shortened the time to complete a set. Sets were completed in approximately 15 minutes.

A seine skiff was necessary to facilitate closing the net during setting and to control the position of the seine boat relative to the seine during retrieval. Strong winds prevalent in the Columbia Gorge were a considerable obstacle to seining as they interfered with control of the seine boat during hauling. Winds over 30 knots prevented seining except *in* the lee of The Dalles Dam such as the cul-de-sac, lock channels, and **forebay** inside the BRZ. Lighter winds often prevailed during the early morning hours 0500 to 0900.

The greatest obstacle to purse seining was the high river flow accompanied by almost continuous spilling at the dams, which occurred through out the entire period of seining. Seining success was limited because there were few places where the current was slow enough for effective seining.

#### Location of Purse Seining Sites

Purse seining occurred at several locations in an opportunistic manner. We tried to fish when ever and where ever we were able. It is difficult to give precise locations of where seines were set; however, the majority of the fishing occurred around The Dalles Dam (cul-de-sac, **forebay** - inside and outside the BRZ, and the upstream and downstream entrances to the navigational lock). We also intensively fished near Miller Island on the north and east banks hoping to find a spawning population of squawfish. Other locations that were fished include: below The Dalles Marina, below Horsethief Lake, near

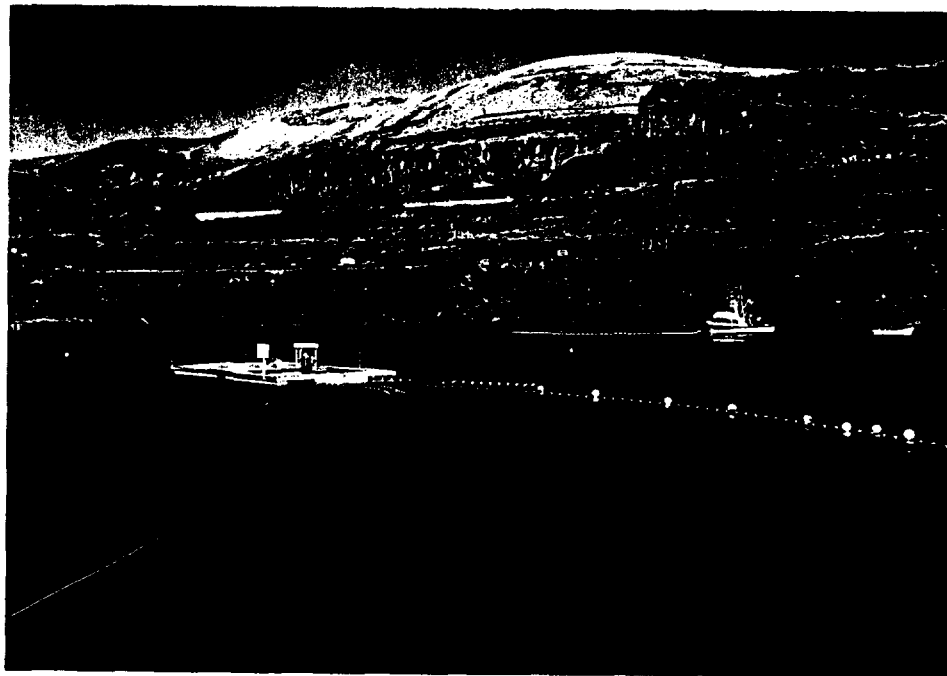

Plate 2.1 ·The Merwin traps' anchoring scheme. U of W Purse Seiner shown in background.

Celilo railroad bridge, the shoal off Mary Hill Park, John Day Lock channel entrance, below John Day River, Rock Creek Lake, and various mid-river locations from Lyle upstream to Rock Creek Lake.

We attempted to seine potential spawning locations as indicated by maps supplied by USFWS whenever possible; however, these areas were generally too shallow or too rocky to effectively seine.

## RESULTS

A total of 89 sets was made during the months of May and June of 1991. A total of 63 northern squawfish were caught composing 7% of the total catch (Figure 2.1). American shad (*Alosa sapidissima*) was the most abundant species caught in the purse seine. 300 shad were captured in one set in The Dalles Dam cul-de-sac. Catches of squawfish were always low; the largest single catch of squawfish was 5 fish in one set.

When fishing in the cul-de-sac, we consistently averaged just over 1 fish per set. At this time the Merwin trap was catching an average of 80 squawfish per day.

We encountered two major problems with this gear. The primary problem was with the unpredictability of the weather. We had higher winds and higher flows than normal throughout our pre-arranged sampling period for purse seining. Due to the large size of the boat, when the winds increased we were unable to fish most areas of the river. Since the river had such high flows, we were unable to get near the dams, the only areas that are fishable when the wind is blowing. The high current was also inhibiting due to the large amount of net that is required to be in the water while purse seining. We needed roughly 15 minutes to make a purse seine set and often we would be carried nearly 1/4 of a mile downstream in this time.

The second major problem was hidden obstacles on the bottom of the river. We felt that we had to fish directly on the bottom in order to capture squawfish, therefore, we often hung the nets up on snags. We rebuilt the small seine (NET #1) three times over the season due to disastrous rips and tears in the webbing. Many fishing days were lost due to time spent mending the seines. Often we would only get one or two sets completed before we would have to scrap the rest of that day and part of the next so that repairs could be made.

## DISCUSSION

In spite of the obstacles of wind and current, enough hauls were made in a variety of locations in the John Day and The Dalles reservoirs during 1989-91 to establish that the purse seine is ineffective in catching squawfish. Purse seines generally are effective on schooled, pelagic fishes which tend to avoid visible obstacles such as nets and will readily lead along the nets.



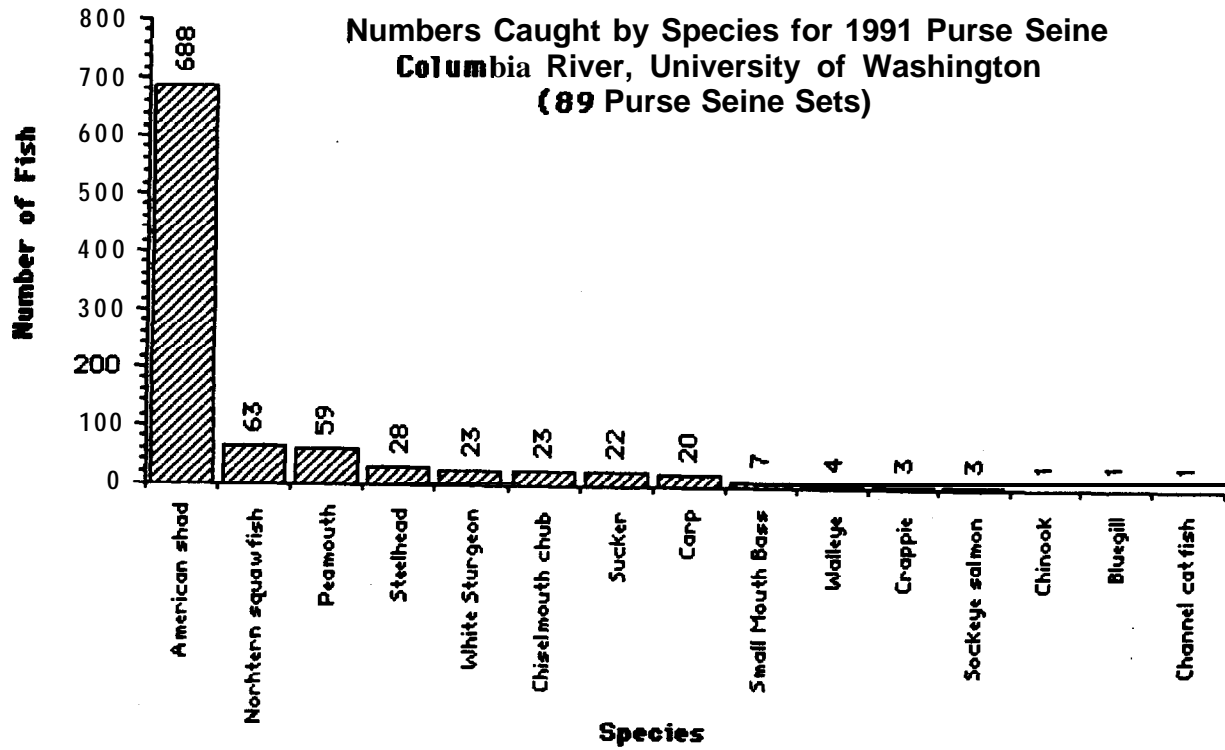

**Species**  
Figure 2.1

According to our purse seining results, there is little evidence that squawfish form into schools during spawning related movements in the **mainstem** Columbia River. They are probably in close association with the bottom during the spring months and probably aggregate to some degree even if not forming distinct schools. An exception to this is the concentration of squawfish near the Columbia River dams which feed on **salmonid** smolts. Squawfish are not vulnerable to purse seining in the Columbia River due to the fact that they do not school or concentrate in places where a purse seine might be deployed safely. As well, squawfish may readily escape the purse seine even when encircled due to their tendency to dive when inside a net. This behavior was observed among squawfish caught in the spiller of the Merwin trap (see Report **3**). A strong diving tendency inside a purse seine would be effective avoidance behavior.



## REPORT 3:

### MERWIN TRAPPING AS A CONTROL TECHNIQUE FOR NORTHERN SQUAWFISH

In determining a method of removal for the northern squawfish (*Ptychocheilus oregonensis*), it is necessary to devise a method which is not only a cost effective means of capturing this fish, but is also non-detrimental to the multitude of species indigenous to the area inhabited by the squawfish. One such method of removal proven previously to be effective for squawfish and with the likelihood of relatively little incidental catch mortality, was the Merwin trap.

Various studies have applied the Merwin trap as a means of capturing specific fish. Hamilton et al. (1970) showed that Merwin traps were extremely effective in catching northern squawfish. From 1960 through 1964, Hamilton operated floating traps at Lake Merwin, Washington (north fork of the Lewis River), during which time over 65,000 squawfish were captured and destroyed.

Lemier and Mathews (1962) fished Merwin traps patterned after Hamilton in the Columbia River. These traps were fished seasonally from 1961 through 1962 at various mid-Columbia sites. Their trap, located in the cul-de-sac area below The Dalles Dam, removed over 15,000 northern squawfish during its two-year operation.

Sims et al. (1977) fished two Merwin traps in the Snake River. One located in the Palouse arm of the Lower Monumental reservoir yielded 57,665 northern squawfish between November 1973 and July 1976; the second trap fished the main stem of the Snake River, at Levey Landing, Washington, from October 1974 to August 1976 capturing 26,633 squawfish. In the summer of 1975, traps fished by Sims (1977) in the forebay areas of the John Day and The Dalles Dams captured a combined total of 1,017 northern squawfish (Sims et al. 1977) (Appendix 3.1).

In addition to proving an effective means of squawfish capture, this method was also employed as a method of capture for different species. Allen (1965) successfully employed Merwin traps in the upper Cowlitz River to capture and tag migrating juvenile salmonids. Erho (1967) used a scaled-down version of a Merwin trap in the Cowlitz River, at Lake Mayfield, Washington. In 1966 this trap captured over 50,000 salmonids between April 4 and August 12.

Based on the success of these previous studies, it was determined that this method of removal could be effective if adapted to present day conditions. The design which was utilized this past season was derived from the designs of traps previously mentioned in this report. Modifications to the trap were primarily improvements on construction materials as well as overall designs. These changes enabled the trap to fish in areas of moderate current such as those present near dams.

Ladder counts of northern squawfish at dams on the Columbia River are shown in Table 2.1. The Dalles Dam has exhibited the second highest historical average of squawfish passage. Lemier and Mathews (1962) found that a Merwin trap placed in the cul-de-sac could successfully remove large numbers of migrating populations of northern squawfish. The cul-de-sac provides

sanctuary from the typically strong winds and currents of the Columbia River. A back eddy, which exists in the cul-de-sac due to its construction, serves to concentrate fish before they migrate past the dam, through the fish ladders. It is for these reasons that The Dalles Dam cul-de-sac was chosen as the location for this trap.

## METHODS

The Merwin trap consists of four components: the lead, heart and wings, **pot**, and spiller (Figure 3.1). The lead is anchored to the shore perpendicular to the current. Fish encounter the lead while swimming along the shore and, in their attempt to swim around this obstacle, are guided into the center of the heart. The heart contains a floor or apron which serves to guide fish up and into the initial enclosure, the pot. From the pot, fish proceed into a connecting tunnel and move into the second chamber, the spiller, where they are retained until their removal.

The lead consists of three panels which, when sewn together, form a single unit, 150 feet long and 35 feet deep. The heart section, which includes the wings and the last 17 feet of lead, consists of panels 30 feet wide and 35 feet deep at the entrance, tapering down to a width of 2 feet wide and 12 feet deep at its conclusion, 7.5 feet inside the pot. The pot and spiller, both 16 feet square and 16 feet deep, were connected by a tunnel measuring 7 feet long. The entrance to the tunnel was 4 feet square with the last 2.5 feet tapering down to an exit 12 inches square. This tapered design prevented fish from escaping the spiller (Figure 3.2).

Web in the lead and trap proper consists of **1.25-inch**, stretched mesh which has been treated with an algicide. Eight-pound window sash weights are hung from the four corners of both pot and spiller in order to insure that the trap hangs straight. Also, additional weights were attached to the heart and lead during periods of high current so as to improve efficiency.

The system of nets comprising the trap are supported by two 20-foot-square, wooden and Styrofoam frames (Figure 3.3). The pontoons of the frame were prefabricated and assembled on site. This particular frame design was chosen based on its low construction cost, low wind profile, high stability in the water, and relative ease in handling and transportation.

The trap was held in position by three lines extending to shore and two lines attached to **Danforth** anchors. The main anchor line extended from the back of the trap to a fixed concrete projection located on the east shore of the cul-de-sac (Plate 3.1). This line was key in maintaining position in the strong current present in the cul-de-sac. Lines also extended from each wing to shore where they were tied to anchors buried in rocks (Plate 3.2). These lines acted both as anchor lines and as a means of holding wing panels away from the lead. In addition to these anchor lines, two **Danforth** anchors were set in the water off the current side of the frame to add stability.

Assemblage of a large Merwin trap and construction of the frame took place at The Dalles Dam beginning in mid-May. This process lasted approximately two weeks with the completion of both frame and net occurring in the last week of

University of Washington  
Merwin Trap

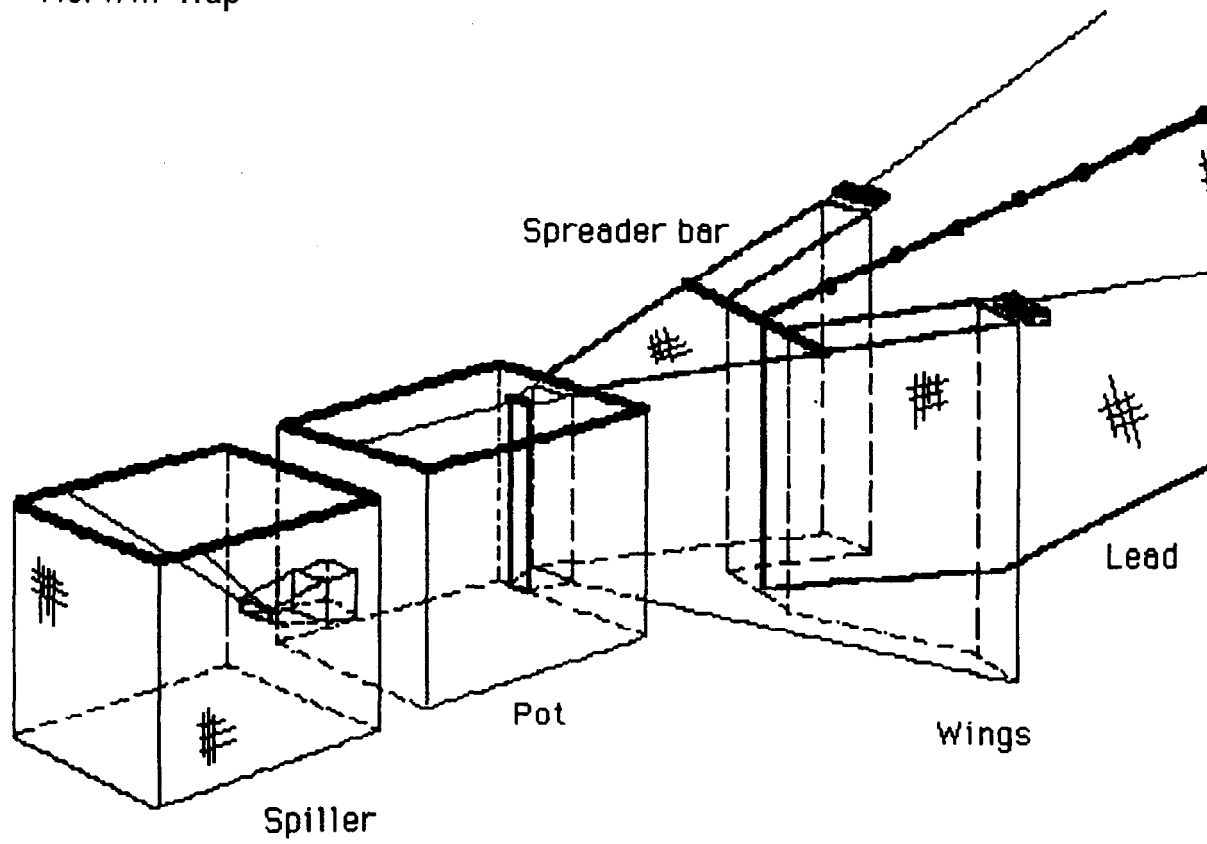

Figure 3.1

**UNIVERSITY OF WASHINGTON MERWIN TRAP**

**Pot and Spiller:** Both are 16 feet square and 16 feet deep. One foot (stretched) 3/8" rope loops are to be attached at the corners and midway between the corners on the underneath side of both the spiller and pot. Similar loops are to be attached at each corner and the midpoints on the surface portion of each trap. On the front wall of the pot a loop is to be attached on the surface at each intersection point with the pot tunnel.

**Spiller Tunnel:** Total length of 7 feet. The entrance is 4 feet square with the last 2.5 feet tapering down to an opening 12" square at the exit. The tunnel is to be centered in the rear wall and 12" down from the top. The tunnel is sewn into the wall of the spiller so that it extends 2.5 feet into the spiller with the exit of the tunnel 3 feet below the surface.

**Pot Tunnel:** 8 feet wide and 15 feet deep (surface to bottom) at the entrance and 2 feet wide and 12 feet deep at the exit. no tunnel will extend 7.3 feet into the pot and will include a floor. The pot is 16 feet deep, but the tunnel entrance is 15 feet deep so that there is a 1 foot sill off the bottom of the floor to restrict the exit of bottom roaming fish.

**Heart:** The outer wings are to be connected to the pot tunnel wings and are 30 feet in length and 30 feet apart at the outer most point. The wings are 35 feet deep at the outer most point and slope up to a depth of 15 feet at the entrance to the pot tunnel. The inner wing 10 feet to be placed 4 feet away and parallel to the outer wing and extend 19 feet towards the pot tunnel. This wall is to be sewn to the floor of the heart. The entire heart is to be floored (Apron) and this floor is to be secured to the pot tunnel floor. The heart lead is to be centered with the outer most point of the heart wings, extending to within 10 feet of the pot tunnel entrance and is even with the ends of the inner wings. The heart lead is 10m sewn by the heart floor (Apron).

**Trap Lead:** The trap lead is 35 feet deep where it joins the heart lead and is 150 feet long (composed of three 50 foot sections).

**Material Specifications**

**Spiller-** Netting: 1-1/4" stretched mesh.  
Cork and Rib Lines: 3/16" nylon rope (soaked and stretched before hanging net) or whatever is suggested by vendor.  
Floats: none.  
Weights: Lead line (2 lbs per fathom) to be used off perimeter of the floor.

**Spiller Tunnel-** Netting: Same as spiller.  
Rib Lines: Same as spiller.

**Pot-** Netting: Same as spiller.  
Cork and Rib Lines: Same as spiller.  
Floats: None  
Weights: Same as spiller.

**Pot Tunnel-** Netting: Same as Pt.  
Cork and Rib Lines: 3/16" polypropylene rope or whatever is suggested by vendor.  
Corks: 3-3/4" x 2-5/8" plastic floats on 18" centers.  
Weights: Lead line (2 lbs per fathom) to be used for perimeter of the floor.

**Heart-** Netting: Same as pot.  
Cork and Rib Lines: Same as pot tunnel.  
Corks: Inner and outer wings 3-3/4" x 2-5/8" plastic floats on 18" centers.  
Weights: Lead line (2 lbs per fathom) to be used for perimeter of Apron.

**Heart Lead-** Netting: Same as heart.  
Cork and Rib Lines: 3/16" polypropylene rope or whatever is suggested by vendor.  
Corks: Same as heart.  
Weights: Lead line (2 lbs per fathom) to be used along bottom of lead.

**Trap Leads-** Netting: Same as heart.  
Cork and Rib Lines: Same as heart.  
Corks: 3-3/4" x 2-5/8" plastic floats on 18" centers  
Weights: Lead line (2 lbs per fathom) to be used along

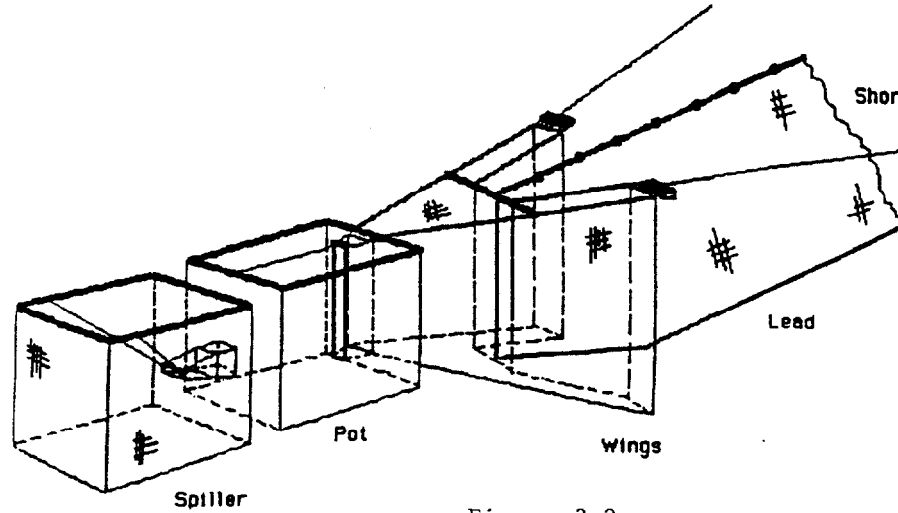
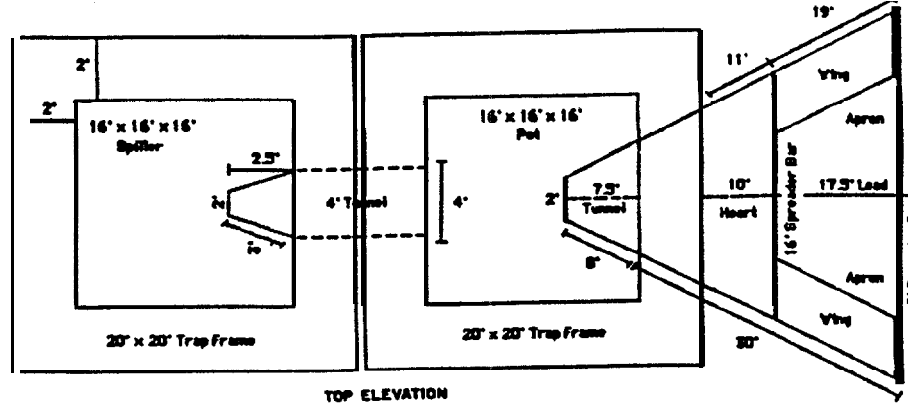
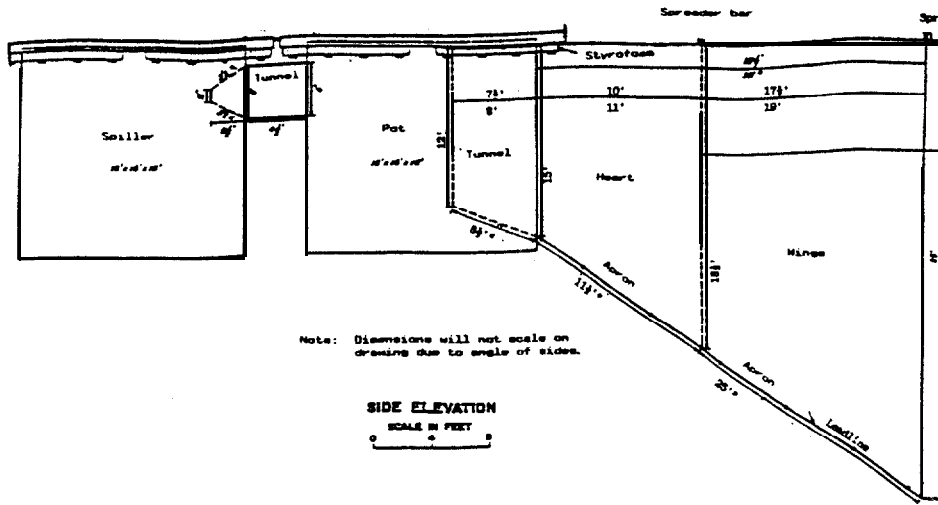

Figure 3.2

UNIVERSITY OF WASHINGTON MERWIN TRAP FRAME

**MATERIAL LIST AND SPECIFICATIONS**

**LUMBER**

- 12 Pc. 2 X 8 X 20'-0" Common Fir (Trap Frame)
- 4 Pc. 2 X 8 X 16'-0" Common Fir (Trap Frame)
- 12 Pc. 2 X 4 X 15'-0" Common Fir (Dock Stringers)
- 4 Pc. 2 X 4 X 20'-0" Common Fir (Dock Stringers)
- 8 Pc. 2 X 4 X 19'-0" Common Fir (Deck Stringers)
- 24 Pc. 2 X 4 X 8'-0" Unfinished (For Securing Styrofoam)
- 4 Sheets 3/4" Marine Plywood (Dock Corners)
- 4 Sheets 3/4" Marine Plywood (Deck)

**BOLTS**

- 210 1/2" Galvanized Nuts
- 80 1/2" X 4' Galvanized Carriage Bolts & Nuts
- 85 1/2" X 2 1/2" Galvanized Carriage Bolt.0 & Nuts
- 12 3/8" X 8" Galvanized Eye Bolts &
- 24 3/8" Galvanized Nuts (Trap Hinge)

**WASHERS**

- 8 LBS. 1/2" Galvanized cut Washers
- 170 1/4" Galvanized cut Washers
- 24 3/8" Galvanized Cut Washers
- a 3/8" Galvanized cut Washers

**SCREWS**

- 8 5/16" X 6" Lag Screws (For Mounting Mooring Cleats)
- 8 LBS. Galvanized Dry Wall Screws (For Securing Plywood Deck Sections)
- 64 2" Galvanized Screw in Hooks (For Attaching Trap Webbing)

**HARDWARE**

- 26 Pc. 2-1/2" X 2-1/2" X 7-1/2" X 3/16" Angle Iron (Corner Brackets)
- Offset Two 8/16" Holes Each Way
- 100 Pc. 1/2" Dim. X 15" Stl. Threaded Rod.
- 3 Pc. 3/4" X 4' Galvanized Pipe (Trap Hinge)
- 8 Pc. 3/4" Galvanized Pipe Nipple (Trap Hinge)

**BUOYANCY**

- 13 Styrofoam Logs 18" X 20" X 8'-8"

**PAINT**

- 3 Gallons Wood Preservative
- 3 Gallons Marine Paint

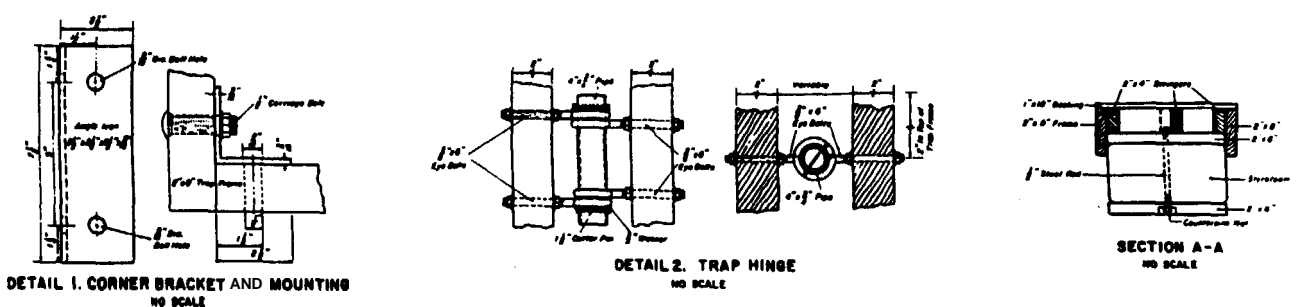
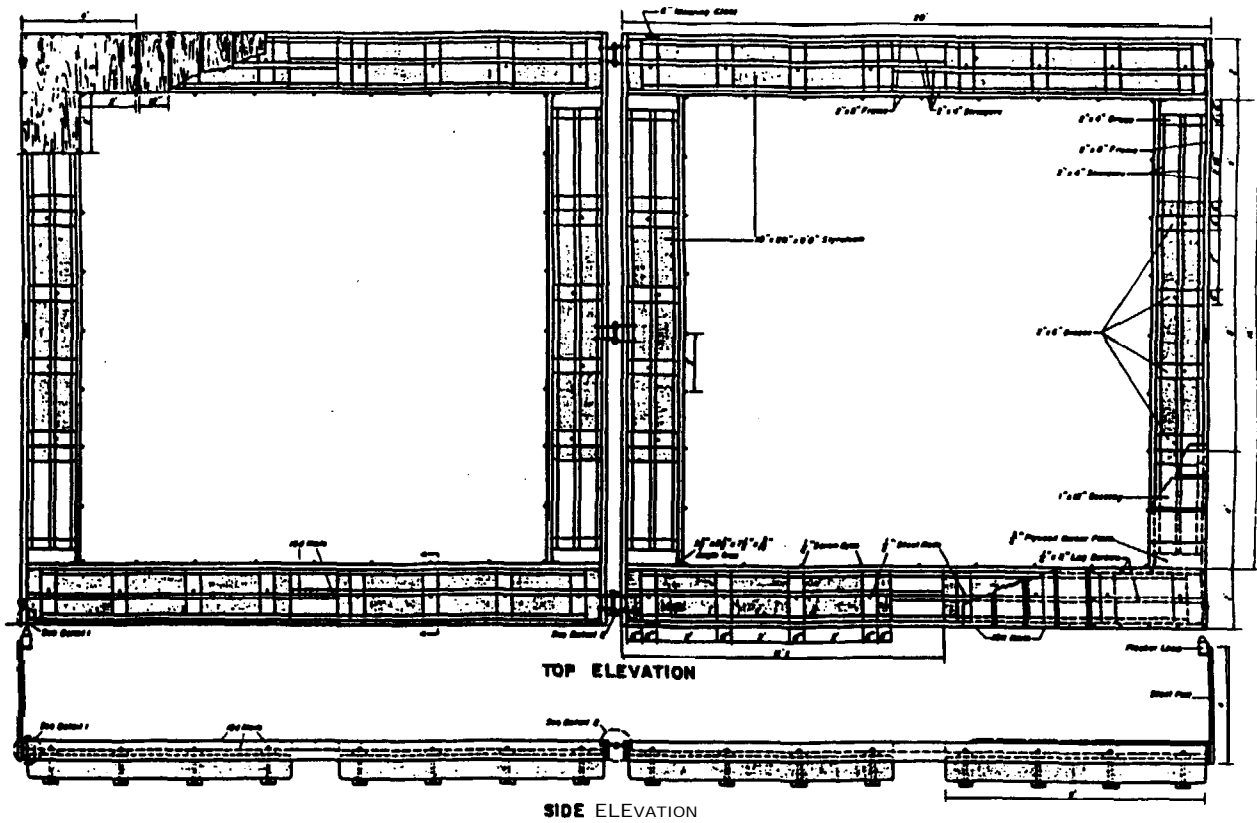

From : U-S- Bureau of Commercial Fisheries, 1964, Fish Passage Research. Review of Progress,

Figure 3.3



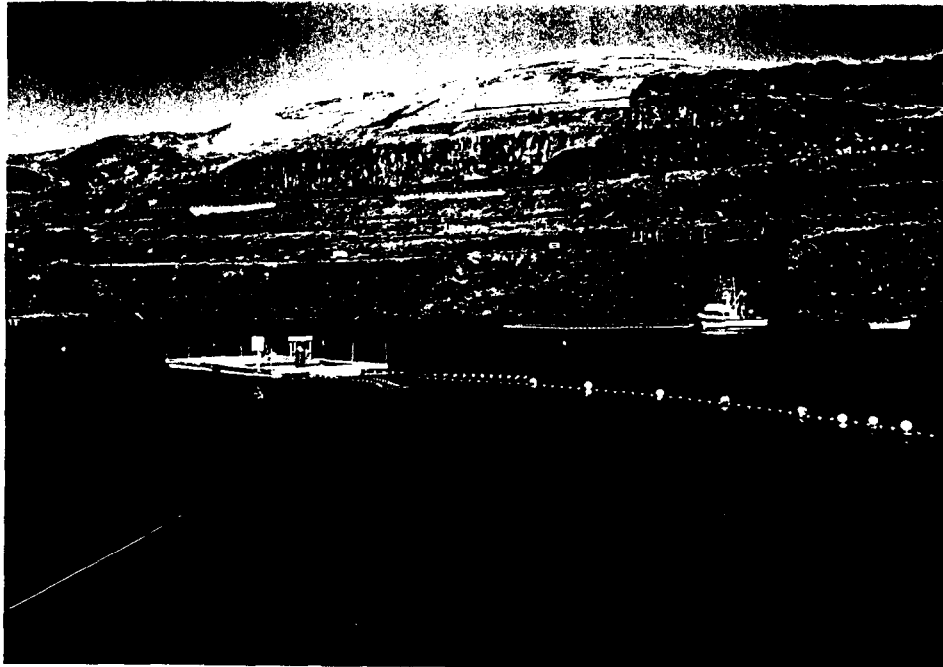

Plate 3.1 The Merwin traps' anchoring scheme. U of W Purse Seiner shown in background.

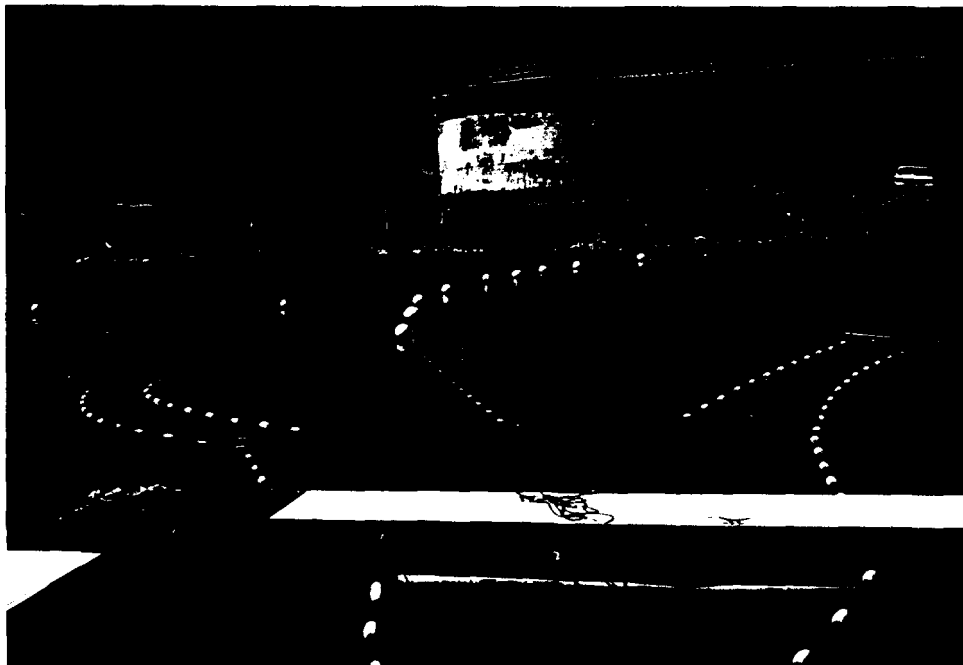

Plate 3.2 Wing anchor lines and lead extending to shore. Rear of East fish ladder shown in background.

May. Fishing began on May 26 with the effort lasting until September 19. Our sampling season for the large trap therefore consisted of 17 weeks of fishing in the area of the cul-de-sac at The Dalles Dam (Plates 3.3 and 3.4).

A smaller trap was fished for a period of four weeks in the cul-de-sac (Plates 3.5 and 3.6) (July 4 - July 25) in several locations and for two weeks near the **tailrace** at **McNary** Dam in Umatilla (August 5-9, 26-30). One of the main limitations of the large trap was its lack of mobility. An attempt was made to deal with this problem by designing and testing a scaled-down version of the original trap. The design for the smaller version of the trap was arrived at by simply reducing all components of the original trap by 50%. This design was intended to be a starting point. Through actual usage, it could then be determined what modifications would be necessary to enable construction of an effective, mobile version of the original trap.

The initial location of the trap, near the north shore of the cul-de-sac, proved to be unproductive for squawfish. As a result of low catch rates, the trap was moved to a new location off the end of the east fish ladder (Figure 3.4) on June 7. This location was chosen due to more favorable conditions such as higher current and better bottom topography, factors which appeared to be more conducive to high squawfish concentrations.

Immediately after this location was assumed, dramatic increases in squawfish capture were observed. During the course of the summer, minor adjustments were made to the lead and wings, but the overall position of the trap remained at this location. It is not clear yet if this location is indeed the optimal location for removal efforts. It is possible that when sufficient numbers of fish are present, many locations would be effective. In the future, this possibility will be explored in order to relate location to effectiveness and to determine whether two or more traps may be more effective in this area.

During the initial week of activity at each location, fishing was carried out continuously in order to determine approximate capture rates. After capture rates were determined, fishing effort was reduced to five days per week, with the trap being closed on weekends. This schedule was maintained for the remainder of the season, from June 14 until September 19 when the trap was removed. Variation in the fishing schedule occurred for one week in August and a weekend in September when web was removed from the water in order to curb algal growth.

The majority of effort required to maintain the trap revolved around periodically reducing the levels of sediments and algae which accumulate on the web. In order to prevent the blockage of the web by these elements, it was found necessary to clean the trap three times per week. Cleaning of the net was accomplished by lifting web out of the water and subjecting it to a high-pressure stream of water, provided by a small, portable pump (Plates 3.7 and 3.8). This process was successful in removing sediment and slowing algal growth, but it did not completely remove all algae. Algal growth was checked by removing the net from the water and allowing it to dry over a period of two days. This process was carried out approximately once a month and proved to be quite successful in dealing with algal buildup.

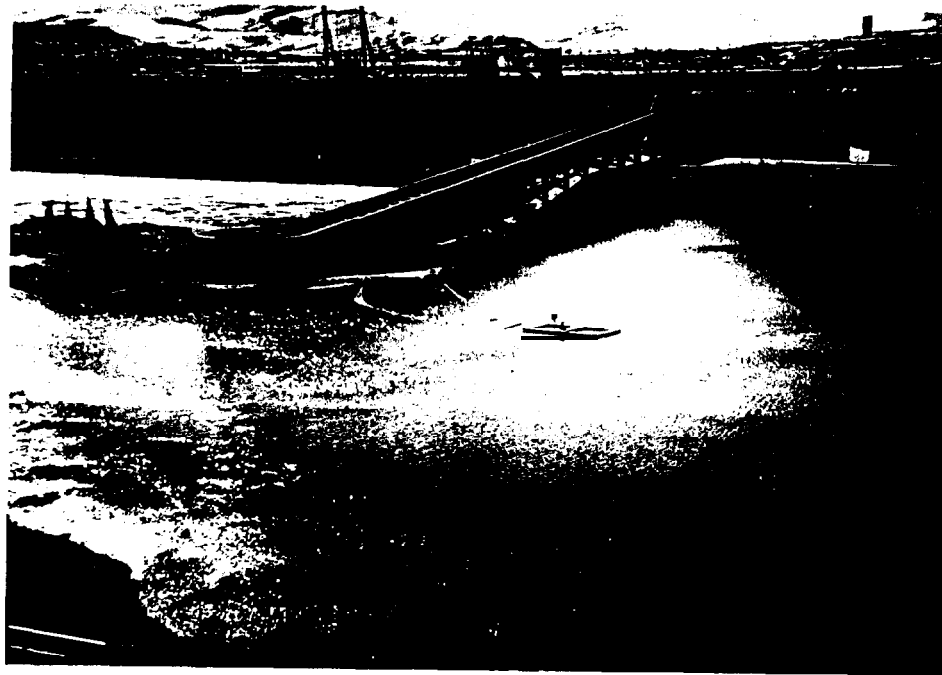

Plate 3.3



Plate 3.4

Plates 3.3 and 3.4 showing the Merwin trap fishing in  
The Dalles Dam cul-de-sac.



Plate 3.5 Smell trap with its lead extending to shore.



Plate 3.6 Both traps fishing simultaneously in the cul-de-sac. The small trap is shown in the foreground.

# The Dalles Lock and Dam

The Dalles Dam cul-de-sac

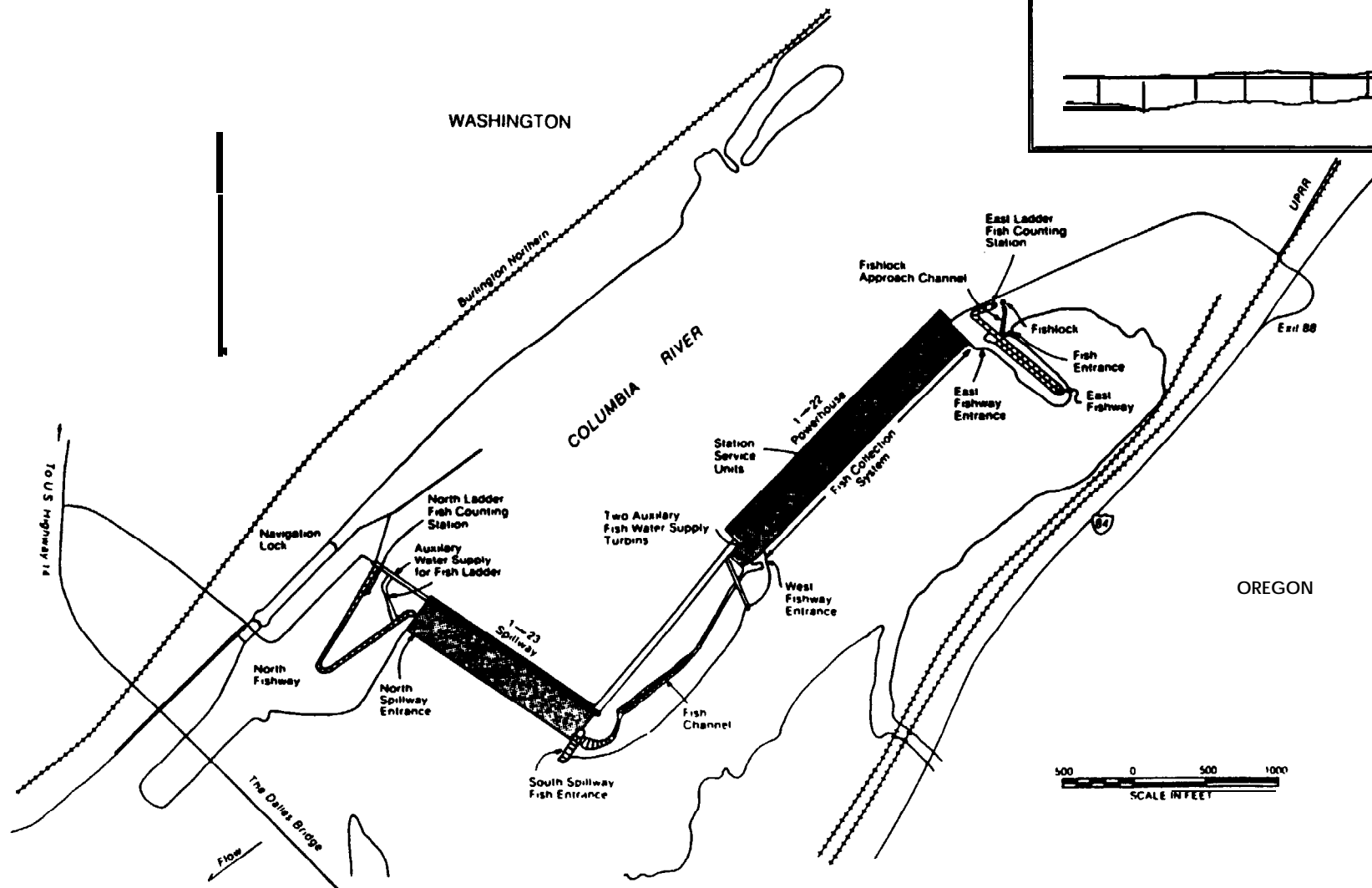
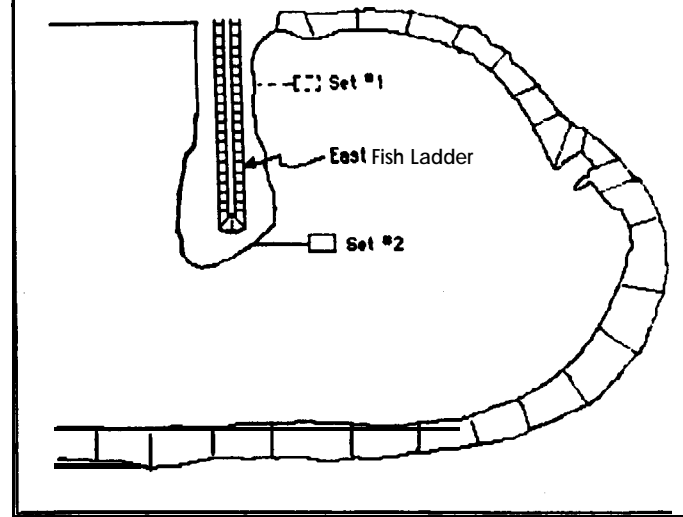

Figure 3.4

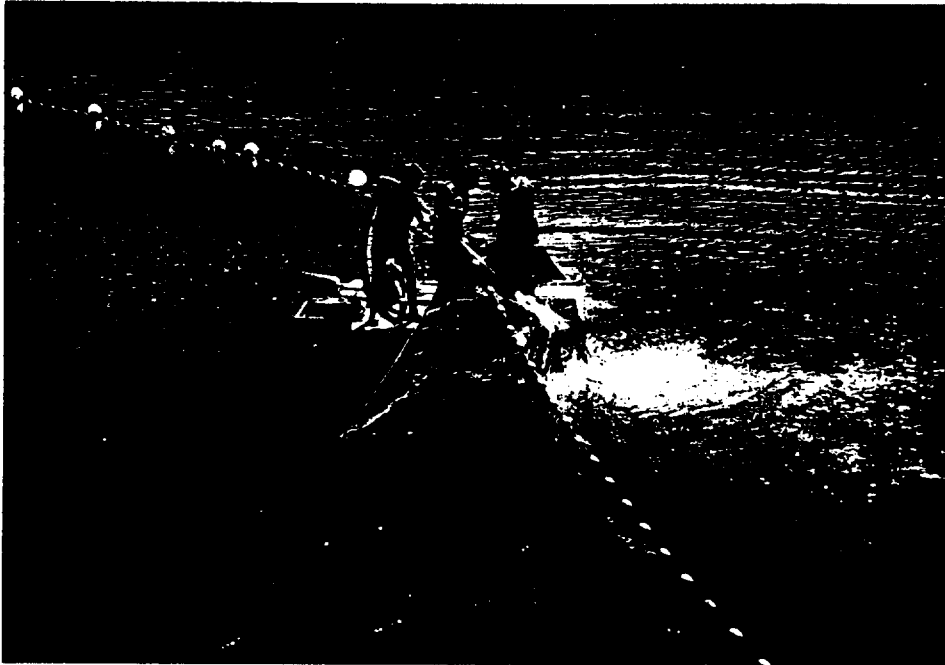

Plate 3.7



Plate 3.8

Plates 3.7 and 3.8 showing the cleaning of the lead.

Removing captures from the trap consisted of confining fish to the spiller portion by lifting web out of the water. Once fish were easily accessible, dip nets were used to remove all fish from the trap, with all incidental catches being returned to the river and northern squawfish either killed (70%) or tagged and released (30%).

In addition to designing, operating, and maintaining the trap, other projects were undertaken in order to better understand the behavior of the squawfish relative to trap catching efficiency and to assess general population abundance. Projects carried out during the course of this summer to obtain such an understanding include biological sampling and tagging of squawfish as well as indexing condition of incidental catch.

During the course of this summer, numerous biological parameters were explored. **Gonadal** somatic indexing (GSI), a measure of sexual maturity, was carried out during peak capture periods. Length frequencies, sexing, and scale samples were also collected from fish over the entirety of the season. Stomach contents of some individuals were also examined in lesser regularity. Valuable insight into squawfish behavior was provided by these data; however, an earlier beginning date for our data collection will yield a more complete view of seasonal changes in squawfish behavior and abundance.

A population study was implemented during the course of this season and consisted of tagging approximately 100 squawfish each week (1,213 fish overall) with a florescent-colored spaghetti tag, easily visible by ladder personnel at dams. Tag color corresponded to a specific week with seven different weeks being represented. Based on data collected from ladder personnel as well as data concerning fish recaptured in the trap, we were then able to approximate the period and rate of migration of the squawfish.

In addition to the collection of data concerning squawfish, incidental catches were also surveyed with an index of condition maintained for all salmonids encountered. Each **salmonid** captured was observed and its condition was categorized as either good, poor, or dead, allowing an evaluation of the impact of the trap on these species.

## RESULTS

The cumulative catch of the Merwin trap, illustrated in Figure 3.5, attests to the effectiveness of this removal method. Total numbers of all species captured exceeded 22,000 fish with 4206 squawfish captured. Several species exhibited relatively high levels of abundance at differing periods in the season.

Early in the season, large numbers of American shad were encountered in the **trap**, but these levels dropped off significantly in a matter of days. Peamouth, chiselmouth, and sockeye salmon all exhibited similar trends in that the majority of these species were captured during a very short period of time. The time period during which these species were captured, when correlated with dam counts, indicates that spawning migrations of these fish were being intercepted. A strong correlation between trap captures and dam counts supports the conclusion that spawning migrations of these fish are

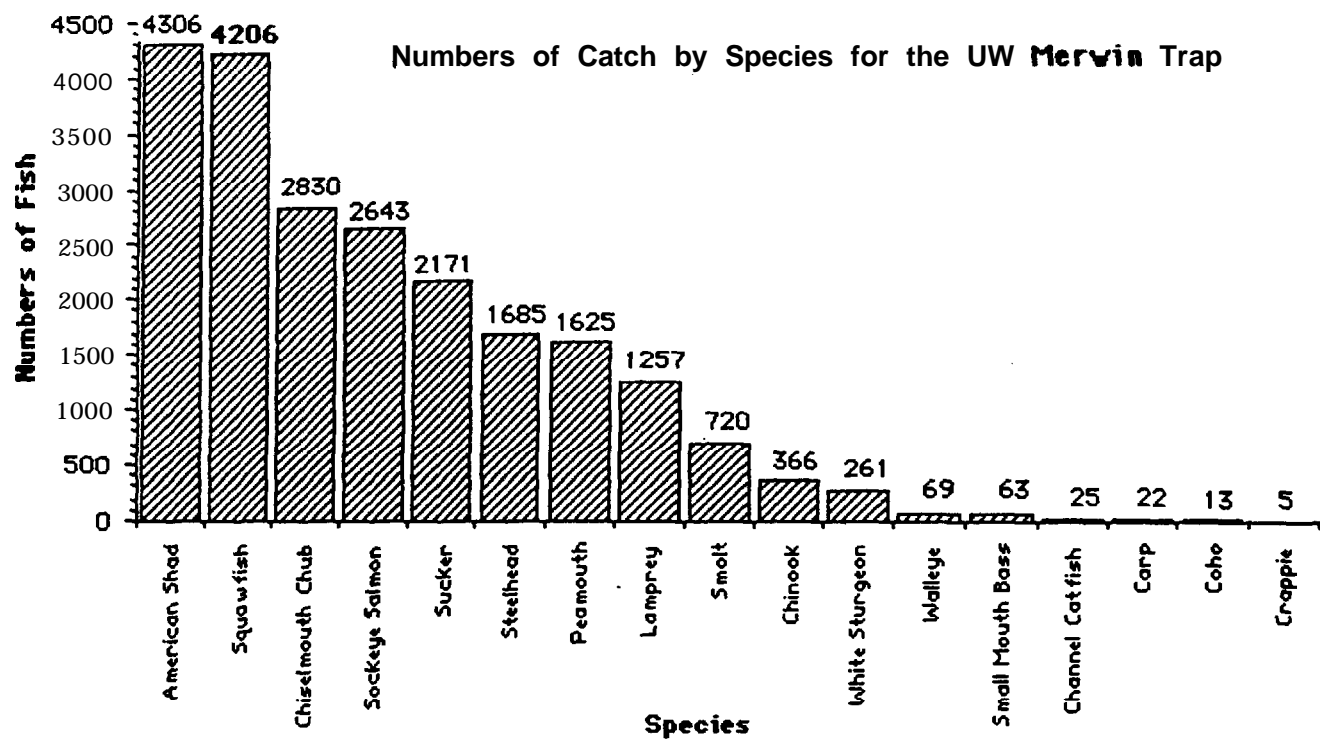

Figure 3.5



intercepted by the trap. The ability of the trap to capture a certain percentage of migrating species allows for greater control and management of populations by agencies utilizing this method of removal.

Northern squawfish, which accounted for approximately 19% of the total catch of the large trap, tended to exhibit a slightly different trend of abundance over a period of weeks. Initially, large numbers were captured in a period of two weeks in June (Figure 3.6), followed by a long-term decline in capture rate. This indicates that after a spawning run is made by this species, a population takes up residence near the dam, unlike other species which were observed in relatively high amounts. Tagging experiments tend to support this conclusion; however, this point will be made clearer by a continuation of the population study in 1992.

A simple breakdown of species caught by percent indicates that the large trap is a nonselective means of capture; however, a full analysis of selectivity would involve a comparison of trap catches with other measures of abundance, such as ladder counts. Some 15 different species were observed this summer, but out of these 15 species, 4 species constituted 63% of the total catch. These included American shad (19.3%), northern squawfish (18.8%), chiselmouth chub (12.7%), and sockeye salmon (11.9%) (Figure 3.7).

In the course of testing the mobile trap, many difficulties were encountered. Mesh size and type were inadequate due to persistent problems of gilled and scaled fish. Insufficient lead and trap dimensions permitted the interference of strong currents with fishing effectiveness. In general, fishing effectiveness was very low due to insufficient proportions of all aspects of the trap. This point is supported by the low catch rates of squawfish exhibited by the mobile trap at both The Dalles and McNary Dams, areas where this trap was fished for a period of weeks this summer.

Cumulative catches for the mobile trap, illustrated in Figures 3.8 and 3.9, demonstrate the need for modifications in original mobile trap designs. Catch rates of squawfish and incidental species were disproportionate to those observed by the larger trap. Northern squawfish constituted approximately 9% of the total catch, far less than the 19% observed by the larger trap. In addition, salmonid captures were much higher in the mobile trap than in the larger trap, with salmonids accounting for over 75% of the total catch of the mobile trap compared to 20% of the total catch of the large trap. This discrepancy in catch rate indicates that the mobile trap requires considerable design modification if effectiveness comparable to the large trap and increased mobility are to be attained.

Recommended modifications to the mobile trap would include increasing the scale of all aspects of design. This process would involve increasing lead length and depth, as well as pot, spiller, and tunnel dimensions. Future models will possess smaller, less coarse mesh as well. In addition to these basic design changes, it would be necessary to improve the mobility of this trap by devising a lighter, more maneuverable frame which could be easily transported by both boat and trailer.

We observed that trapping places a minimal amount of stress on incidental catches. The trap operates like a large holding pen. An indication of this point is that, of the over 4,000 salmonids captured, only 2 mortalities were

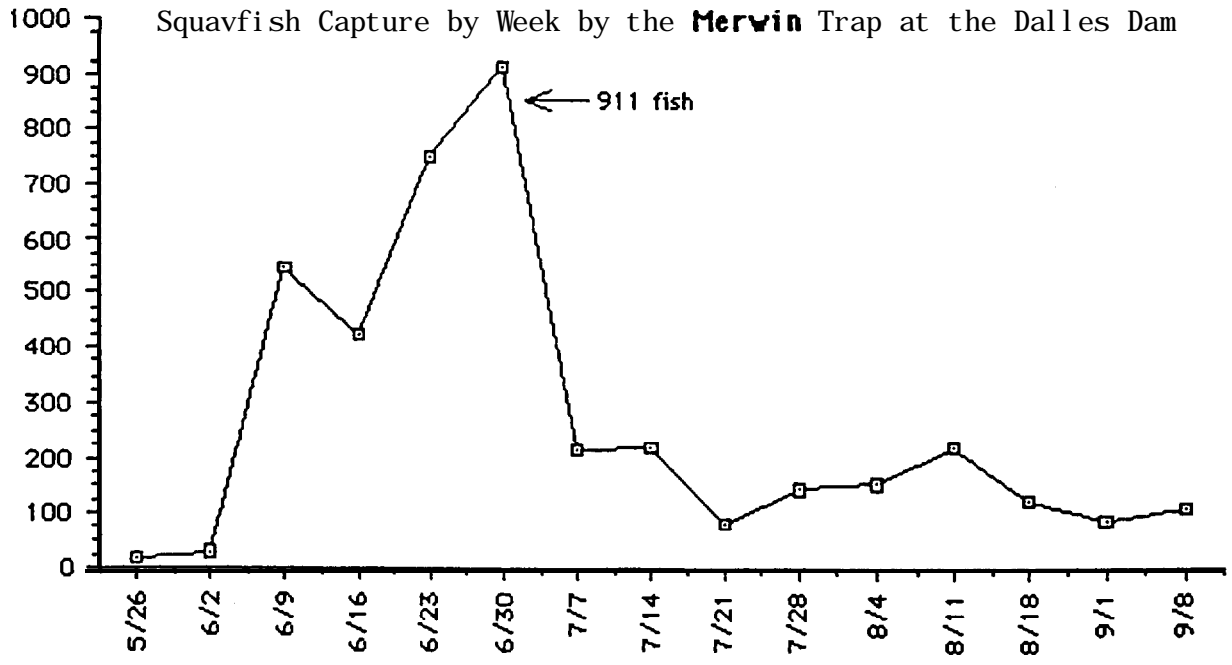

Note: The trap was not fished the week of 8/25.

Figure 3.6

Percentages of Catch by Species for the Large Merwin Trap

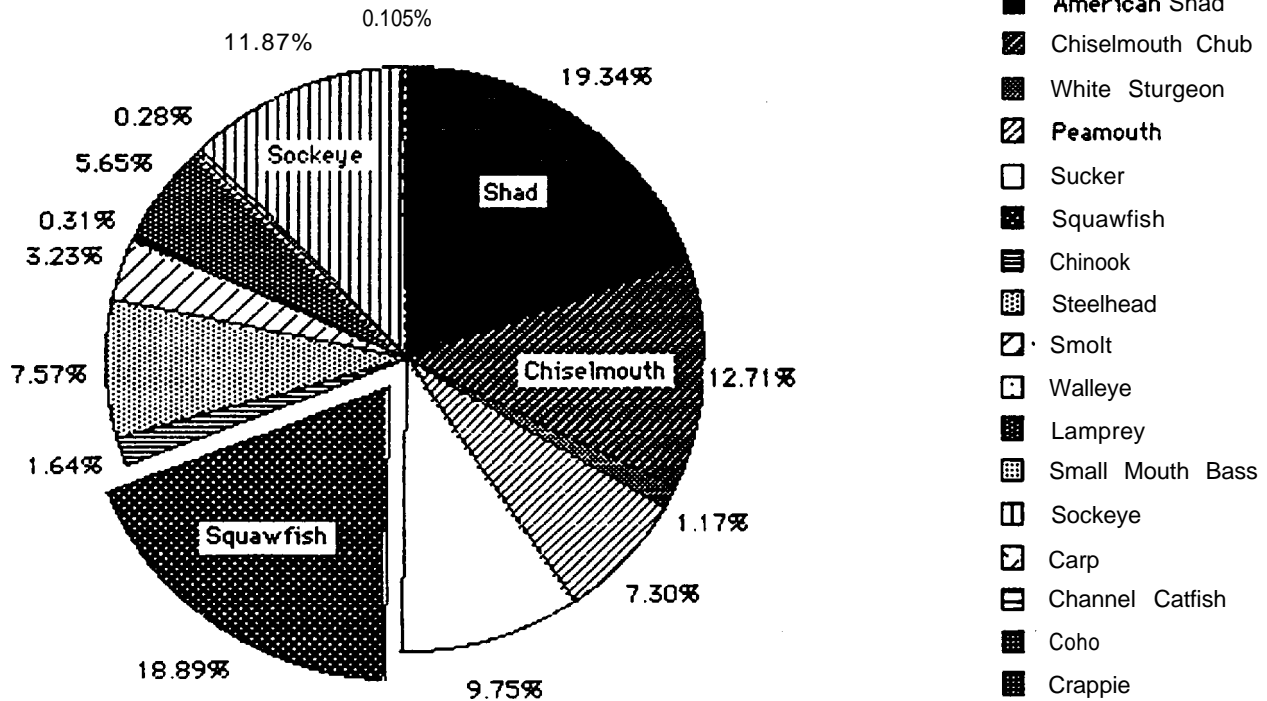

Figure 3.7

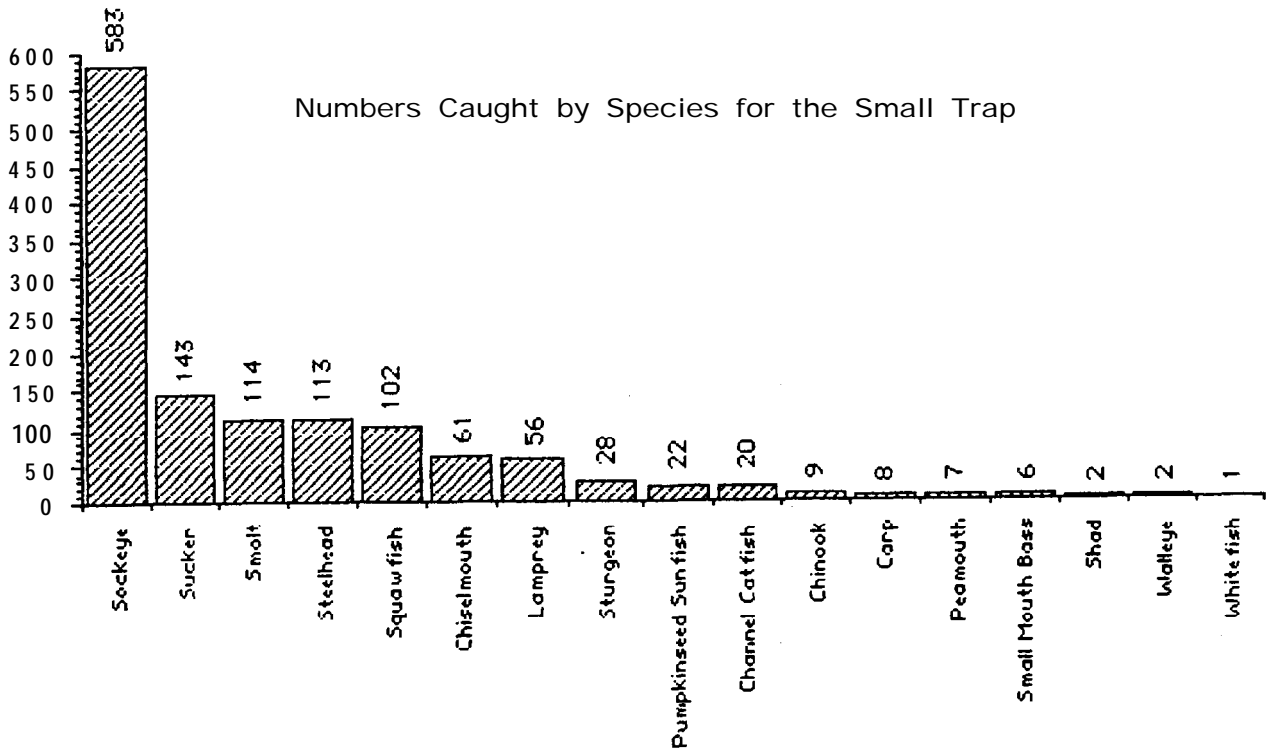

Figure 3.8

Percentages of Catch by Species for the Small Mervin Trap

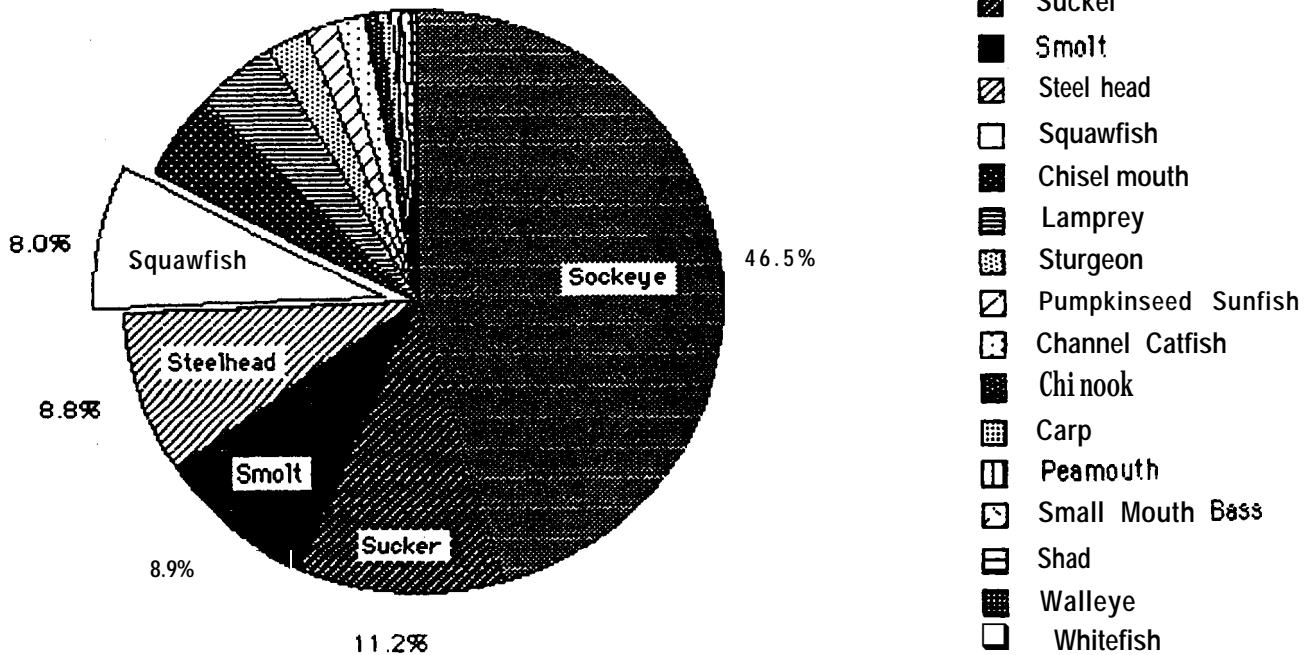

Figure 3.9

observed. It should be noted that these mortalities occurred during removal of the trap from the water for cleaning, not from injury due to capture. Late in the season, increased numbers of steelhead were categorized as "poor" due to high water temperatures.

In an effort to **reduce** high incidental catches of nontarget species, fishing periods were altered to try and maximize our capture of northern squawfish and minimize incidentally caught species. For example, we experimented with daytime versus nighttime fishing and found significantly higher ratios of squawfish to salmonids during the night. During daytime, **salmonid** captures occurred more frequently (Figure 3.10). Results from this experiment led to the fishing of the trap exclusively at night during periods of high **salmonid** abundance.

One major concern prior to fishing with the trap was that small fish, particularly smolts, would be gilled in the mesh of the pots or the lead. This problem was virtually nonexistent; apparently the mesh size was sufficiently small or sufficiently visible to the fish for avoidance. Our general conclusion is that the large Merwin trap has little negative impact, certainly at relatively low river temperatures, on incidentally caught species. When river temperatures were highest, potentially increasing stress on adult salmonids, squawfish catch rates were lowest. In the future, this problem can be dealt with by fishing exclusively at night during periods of high **salmonid** density or by ceasing operations until ladder counts indicate decreased **salmonid** presence.

Upon review of preliminary data, definite migrational trends are apparent. Squawfish migration appears to have occurred in mid- to late June, with residence being established in late August. The continuation of a tagging program in the future will provide greater insight into population densities around The Dalles Dam as well as a better understanding of migrational behaviors of this species.

Biological data obtained this season has exhibited many interesting trends. Average lengths and maturity of fish appeared to peak in mid-June, corresponding to peak catch rates observed by the trap. In addition, relative abundance of females was quite high during this period of the season. As maturity and average lengths of captures dropped off in early August, the abundance of females decreased with males exhibiting a strong increase in abundance. Figures 3.11 and 3.12 illustrate the length-frequency breakdown of fish caught by the Merwin trap at The Dalles Dam as well as a length-frequency breakdown of sexed fish.

In addition to the biological trends which were observed, an interesting behavioral observation concerning squawfish was made during the course of this season. While other fishes tended to swim near the surface of the trap when confined, squawfish consistently dove to the deepest possible portion of the net. This observed avoidance/diving behavior may explain some of the difficulties encountered with purse seining; squawfish may simply dive beneath the net before pursing.

Additional correlations between trap catch rates and water temperatures indicate that this factor may play a role in trap efficiency. Preliminary temperature data indicate that squawfish migration may be linked to

**Catch for Day versus Night Fishing  
(August 12 thru 18, 1991)**

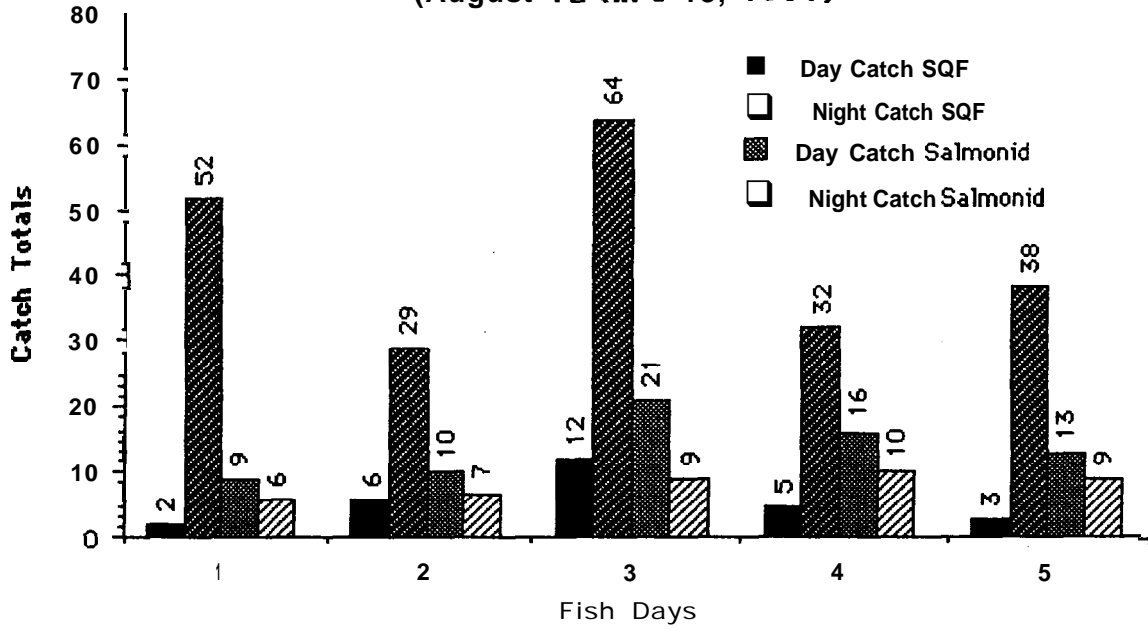

Note : 12% of Squawfish caught during the day, 63% of Salmonids caught during the day.

Figure 3.10

**Length Frequency of Squawfish Caught by the Mervin Trap**

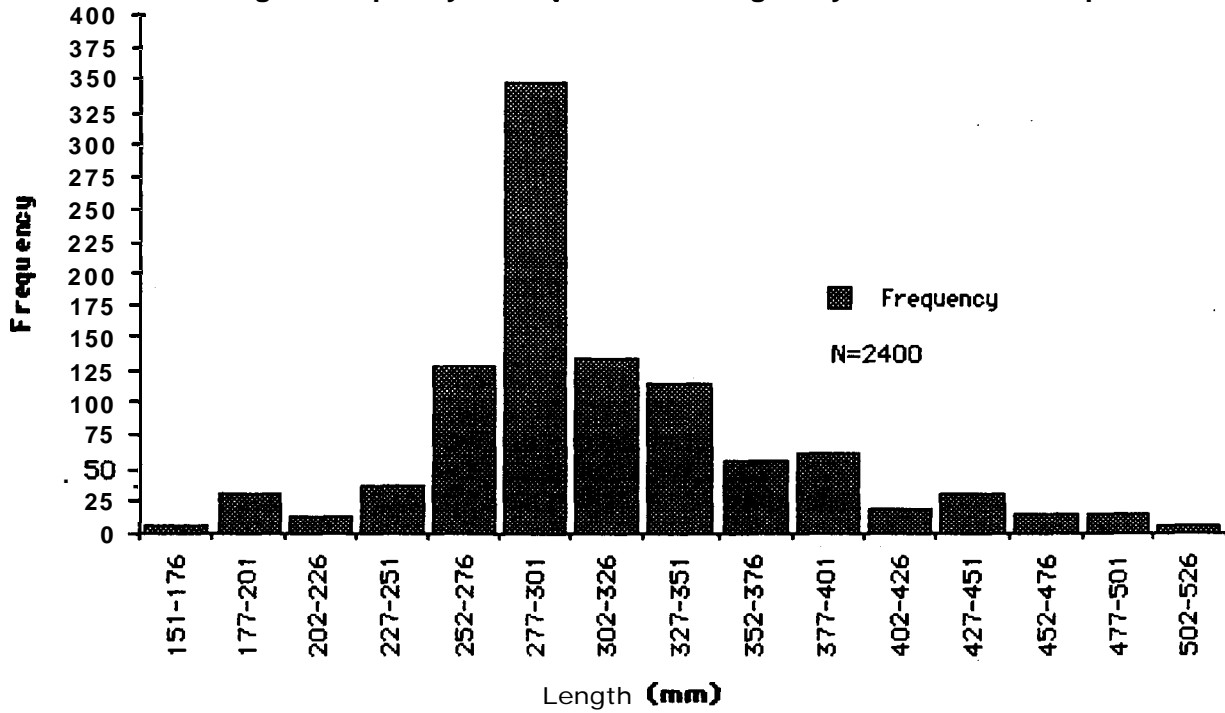

Figure 3.1 1

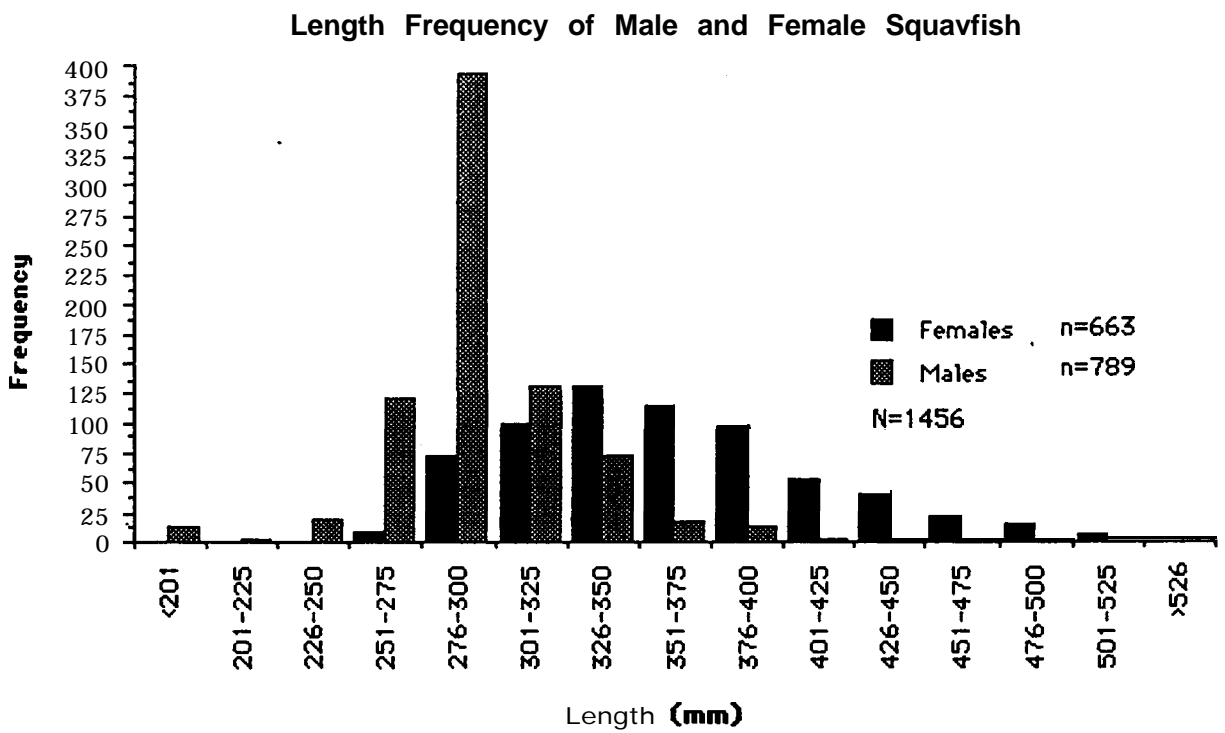

Figure 3.12

fluctuations in water temperature (Figure 3.13), with peak capture rates occurring at or near 60 degrees (F) in 1991.

Many difficulties arose during the course of this fishing season due to unforeseeable circumstances. Adverse conditions such as rapid water level fluctuations, high current, and limited mobility were all observed during the course of this season. In addressing these problems, a better understanding of the modifications necessary to improve this method of removal have been determined.

Rapid fluctuations in water level were a common occurrence in the cul-de-sac at The Dalles Dam. Water level was compared to a fixed point each day so as to give an index of fluctuation. These fluctuations affected numerous mechanical aspects such as lead tension and amount of lead in the water as well as increased stress placed on various components of the trap. This continuous variation in water level was thought to decrease trap efficiency, but when water level fluctuation was correlated with catch rates, no significant relationship was observed. This indicates that water level had little affect on fishing efficiency, but numerous mechanical adjustments which were necessitated by water level fluctuations may have accounted for this result.

Due to strong currents present in the cul-de-sac, many modifications had to be made in the trap's original design. Strong currents tended to force wing panels into contact with the lead, thus closing the trap and reducing effectiveness. This problem was overcome by placing bars between the wings and the lead, in order to hold these openings apart. Another modification which was necessitated by high current was the replacement of the main spreader bar with a bar constructed of a heavier gauge material (Figure 3.1). Strain placed on the bar by current caused the original PVC bar to break. The use of a metal bar prevented this problem from reoccurring.

## DISCUSSION

Data collected this past season has provided much insight into the operation of the Merwin trap, as well as providing an understanding of the behaviors of the squawfish. These data have, however, underscored a point which is key to fully determining how traps should be deployed, i.e., that our season should be extended on either end to include April and all of September. Data collected this season failed to provide sufficient samples early in the season partly due to our late starting date (May 15) and partly due to our inexperience in operating the trap.

In addition to improving our biological profile regarding the squawfish, improvements in efficiency can be gained through the alteration in design and structure of both large and mobile traps. Both traps require mesh that is nonabrasive and of sufficient size to guard against injuring smaller fish. Both traps may also require larger leads for maximum efficiency. Individual lead panels on the large trap should be outfitted with zippers to enable easy modification of lead length. The mobile trap should be equipped with a customized frame and anchoring system to allow easier setting and moving.

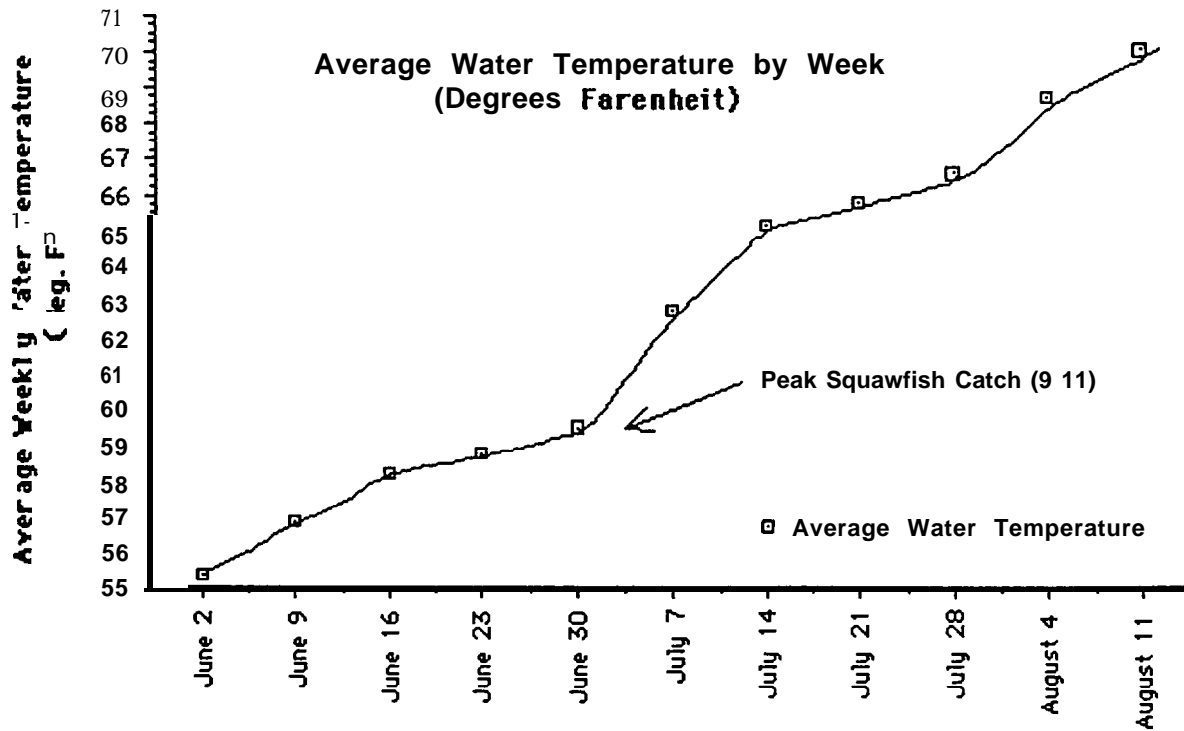

Figure 3.13

Continued fishing of these traps with modifications such as these will provide greater insight into the potential of this method of removal.



## GENERAL SUMMARY

Longlining may be of limited effectiveness for removing northern squawfish from the Columbia River. This is not due to the effectiveness of the gear; however, it is due to unforeseen social and economic factors involved in creating this new tribal commercial fishery.

The interest level among the eligible fishermen does not appear to be adequate to provide for a productive fishery. Of all the potential fishermen that are eligible to participate in this program, only 30 tribal members expressed any interest in this fishery. Only nine of these fishermen actually tried fishing for squawfish.

The most common reason cited from fishermen who signed up for the fishery and did not go fishing was that they could not afford the daily expenses involved in learning how to catch squawfish on the longline. The number one expense was gasoline for their boats and for their vehicles getting to and from check stations.

The most common complaint about the fishery was the amount of paperwork and level of interaction of the government agency (ODFW) that was involved in administering this fishery. They felt that as fishermen they were not fully trusted to report their actual catch.

If this fishery is to continue, these issues must be addressed. We felt the level of interaction from ODFW was necessary. It was due to the low participation that the amount of observed fishing trips was so high. Also, at least two fishermen were suspected of illicit use of the **longline** gear and were therefore asked to restrain from participating in the fishery. ODFW observers are necessary for this program. Another issue that must be addressed is the daily expenses involved while participating in the reward program. Some thought needs to be put into other ways of administering the award program, such as contracting the fishermen for squawfish removal in specific locations of high squawfish abundance.

Purse seining is not an effective method for capturing squawfish. We have shown that chasing after squawfish with a purse seine is not productive. There are previous examples where purse seining has been extremely effective in isolated cases; however, these rare occurrences seem to be the chance **biprodukt** of extensive effort and much failure.

Merwin trapping has proven to be the most promising squawfish removal gear that we have tested. The traps have low cost, require minimal effort, and produce satisfying results. We feel that the large Merwin trap should again be fished in the cul-de-sac of The Dalles Dam. We also believe that a mobile trap needs to be developed for deployment in other areas along the Columbia and Snake Rivers (Appendix 3.1).

Other methods of removal should also be investigated. One of these methods is electroshocking. The predator indexing crews have consistently had the highest northern squawfish CPUE by using electroshocking boats. Yet their efforts have been confined to collecting biological data from every fish they capture. A boat could be outfitted with electroshocking gear under the premise of removal instead of biological research. Of course, this method

must be investigated further before large-scale effort occurs. Incidental harm to other species is still unknown.

## BIBLIOGRAPHY

- Allen, Richard. 1965. Juvenile Fish Collector Operation at Lake Mayfield. Unpublished. Washington Dept. of Fisheries. 23 pp.
- Erho, Michael W. 1967. Evaluation of Floating Traps for Collecting Downstream Migrating Salmonids from the Upper End of a Reservoir. Unpublished. Washington Dept. of Fisheries. 31 pp.
- Hamilton, J. A. R., L. O. Rothfus, M. W. Erho, and J. E. Remington. 1970. Use of a Hydroelectric Reservoir for the Rearing of Coho Salmon (*Oncorhynchus kisutch*). Washington Dept. of Fisheries. Research Bulletin 9. 65 pp.
- Lemier, E. H., and S. B. Mathews. 1962. Report on the Developmental Study of Techniques for Scrapfish Control. Washington Dept. of Fisheries. Contract Report to the U. S. Fish and Wildlife Service, Columbia River Fishery Developmental Program (Contract Numbers 14-17-001-373, 14-17-001-538). 60 pp.
- Mathews, S. B., and T. K. Iverson. 1991. Evaluation of Harvest Technology for Potential Squawfish Commercial Fisheries in Columbia River Reservoirs. University of Washington, Annual Report to Oregon Dept. of Fish and Wildlife. BPA Project Number 90-077.
- Mathews, S. B., T. K. Iverson, R. W. Tyler, and G. T. Ruggerone. 1990. Evaluation of Harvesting Technology for Potential Northern Squawfish Commercial Fisheries in Columbia River Reservoirs. University of Washington, in A. A. Nigro (ed), Developing a Predation Index and Evaluating Ways to Reduce **Salmonid** Losses to Predation in the Columbia Basin. Oregon Dept. of Fish and Wildlife, Contract #DE-A179-88B92122. Annual Report to Bonneville Power Administration, Portland, OR.
- Sims, C. S., R. C. Johnson, and W. W. Bentley. 1976. Effects of Power Peaking Operations on Juvenile Salmon and Steelhead Trout Migrations. NOAA, NMFS, Northwest and Alaska Fisheries Center, Seattle, Washington. Progress Report to U.S. Army Corps of Engineers. Contract DACW68-77-0025.
- U. S. Army Corps of Engineers, Portland and Walla Walla Districts. 1938-1990. Annual Fish Passage Report, Columbia and Snake Rivers for Salmon Steelhead and Shad. North Pacific Division Corps of Engineers.
- U. S. Bureau of Commercial Fisheries. 1964. Fish Passage Research Program, Review of Progress. Observations on Downstream Migrant Salmonids, Shasta Reservoir, California.

Appendix 1.1. Announcement letter for the 1991 tribal **longline** fishery for northern squawfish in the Columbia River.

UNIVERSITY OF WASHINGTON  
SEATTLE, WASHINGTON 98195

*Center for Quantitative Science  
in Forestry, Fisheries, and Wildlife*

February 5, 1991

Dear Tribal Fisher:

This letter is to announce a possible longline fishery for northern squawfish within the Zone 6 fishing area from May 1 through September 31, 1991. The fishery is to be conducted by the Oregon Department of Fish and Wildlife (ODFW) in cooperation with the University of Washington (UW). If this fishery occurs, all qualified applicants will be allowed to participate. Fishers will be paid by bounty only. no other means of compensation will be available this year. If you are interested in this fishery, please read the following information carefully.

BACKGROUND

Predation by northern squawfish is a significant cause of mortality to salmon and steelhead smolts in Columbia River reservoirs, and fishery managers are looking for ways to reduce the problem. Researchers from ODFW and UW tested various types of commercial fishing gear in the John Day Reservoir during 1989 and determined that baited longlines could be an effective method for capturing squawfish. In 1990, a small scale fishery occurred in the John Day Reservoir including three tribal fishers, and it was determined that a full scale subsidized commercial fishery may be effective at removing squawfish in 1991.

FISHERY DESCRIPTION

Fishing Period

Fishing may occur during any hour of the day, Monday through Friday from May 1 through September 30, 1991. No longline fishing gear will be allowed to fish, or remain in the river over the weekends.

Participation Requirements

Tribal fishers will have to be certified by ODFW/UW before participating in the 1991 squawfish fishery.

Fishers will be required to report to pre-arranged registration sites at least once per day in order to inform ODFW observers of fishing locations and times. In this way an ODFW observer can be randomly placed aboard any participating fisher's vessel before that fisher pulls the gear. Important catch data will be collected by the observer in order to evaluate the effectiveness of this fishery.

Fishers will also be required to record information in a log book that will be provided by ODFW/UW. This confidential log book will provide important information about time of day, location and catch for each longline set for future squawfish fisheries management.

#### Gear

The individual fishers will be responsible for providing their boat and some of their own gear (anchors, buoys, buoy lines, and other general elements of the longline). However, a start-up kit will be provided to each participating fisher, which will include a longline apparatus and the main components necessary for effective fishing (such as mainline, snaps, and hooks).

A manual describing longline gear assembly and fishing methods will be provided. A "help-line" number will also be available, so that any fisher with questions concerning the gear or the deployment of the gear can get help throughout the season in a timely fashion from UW researchers.

#### Boat

One of the main criteria for participating in this fishery is the size of the boat to be used. It is important that the boat be large (at least 18 feet) and seaworthy enough to accommodate three people plus gear. The boat will also be required to meet minimum Coast Guard safety requirements.

#### Personnel

There are no personnel requirements, however, it is highly recommended that a two person crew is used for each fishing vessel. This allows one fisher to operate the boat while the second handles the gear. An ODFW observer will be randomly placed aboard each vessel throughout the fishing season; however, the fishers will not know on what days this will occur until the day of observation.

#### Fishing Area

Fishing will occur within the Zone 6 treaty area. It has not yet been determined whether this fishery will be limited to the Bonneville pool or throughout Zone 6.

### Compensation

Fishers will be paid \$4.00 per northern squawfish over 11 inches total length. No other form of compensation will be included in this years' fishery.

In order to receive their compensation, the fishers must have been certified by ODFW/UW for participation in the fishery and must have registered with ODFW before setting and pulling lines. The fisher must deliver the squawfish to a designated registration site with a completed log book entry showing all pertinent information on how and where each squawfish was caught.

### Condition of Catch

Fishers will only receive compensation for squawfish that are in premium condition (fresh caught). It will be the decision of the ODFW observer, as to what fish qualify for payment. In order to achieve this fresh caught condition, fishers will need to ice their fish as they are caught.

### FISHER QUALIFICATIONS

In order to be certified for this fishery, a limited number of qualifications must be met. Participating fishers must be enrolled members of either the Nez Perce, Warm Springs, Umatilla, or Yakima tribes. Fishers must also have a boat that is at least 18 feet long and can handle all necessary longline gear. This boat must have necessary Coast Guard approved safety equipment and be proven to be mechanically reliable.

### HOW DO YOU EXPRESS YOUR INTEREST IN THIS FISHERY?

If you wish to participate in this fishery, you must complete and return the enclosed questionnaire to UW by March 1, 1991. Please contact Steve Mathews, 206-543-4458, or Tom Iverson, 206-685-1331, if you have any more questions. This announcement is not a guarantee that the fishery will occur.

QUESTIONNAIRE

If you wish to participate in the 1991 northern squawfish fishery, please answer the following questions and return this form by March 1, 1991. to:

University of Washington  
ATTN: Tom Iverson  
CQS, mailstop HR-20  
Seattle. WA 98195

\*\*\*\*\*

Name: \_\_\_\_\_ Phone: \_\_\_\_\_

Mailing Address: \_\_\_\_\_  
\_\_\_\_\_  
\_\_\_\_\_

Tribe: \_\_\_\_\_ Enrollment Number: \_\_\_\_\_

- 1) What is the size of your boat?  
Length: \_\_\_\_\_ Width: \_\_\_\_\_
- 2) Can three persons work comfortably and safely in your boat, even in moderately rough water?  
YES (circle one) NO
- 3) In which reservoir do you normally fish? \_\_\_\_\_
- 4) Briefly describe your fishing experience.  
\_\_\_\_\_  
\_\_\_\_\_  
\_\_\_\_\_  
\_\_\_\_\_  
\_\_\_\_\_
- 5) Will you allow an ODFW observer aboard your vessel in order to collect information about the squawfish fishery at any time during the fishing season?  
YES (circle one) NO
- 6) Are you willing to keep a log book on your daily squawfish fishing activities?  
YES (circle one) NO



7) Will you abide by all rules and regulations that are established for the 1991 squawfish fishery by ODFW and UW?

YES (circle one) NO

I hereby attest that this information is true and accurate to the best of my knowledge and hereby acknowledge that this announcement and questionnaire do not guarantee that a subsidized commercial fishery for squawfish will occur.

Signature ----- Date -----

Appendix 1.2. **Longline** manual for the 1991 tribal **longline** fishery for northern squawfish in the Columbia River.

**1991 SUBSIDIZED  
NORTHERN SQUAWFISH  
COMMERCIAL LONGLINE FISHERY**

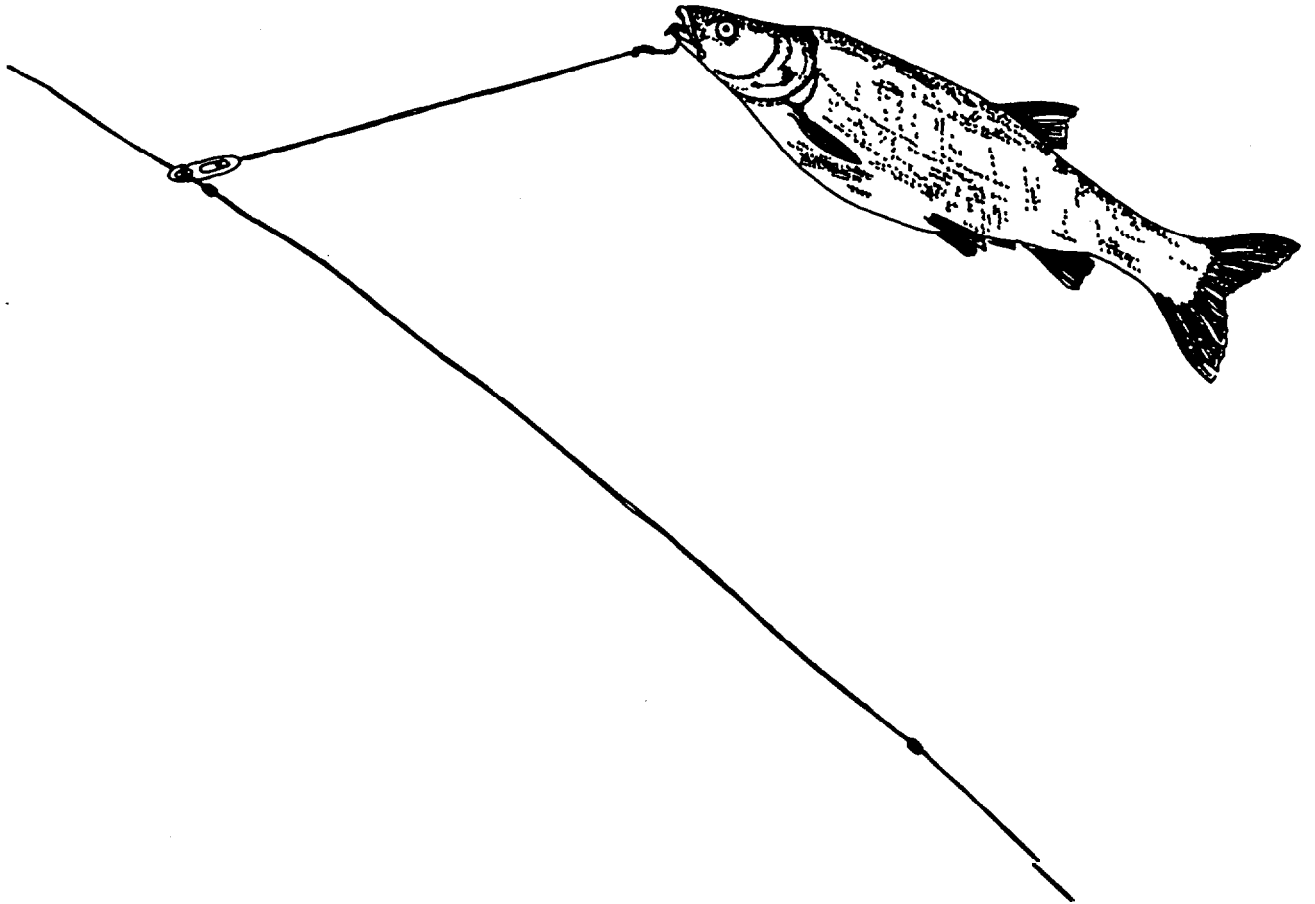

**UNIVERSITY OF WASHINGTON  
AND  
OREGON DEPARTMENT  
OF FISH AND WILDLIFE  
2nd Edition**

**SQUAWF'ISH HOT LINE**  
**FOR THE TRIBAL LONGLINE FISHERY**

**(Call collect between 8 a.m. and 8 p.m.)**

**(503) 298-1459**

Illustrations by April Richardson

Certification Number: \_\_\_\_\_

Fisherman: \_\_\_\_\_

Fisherman's Address: \_\_\_\_\_

\_\_\_\_\_

\_\_\_\_\_

\_\_\_\_\_

Fisherman's Phone Number: \_\_\_\_\_

## **Tribal Longline Fishery Information --**

Contact: Christine Mallette  
Field Office --  
Cascade Locks, OR  
(503) 374-8357

Oregon Department of Fish and Wildlife  
17330 SE Evelyn Street  
Clackamas, OR 97015  
(503) 657-2038

## **Longline Gear Information --**

Contact: Tom Iverson  
Field Office--  
The Dalles, OR  
(503) 298-1459

University of Washington  
Mailstop HR-20  
Seattle, WA 98195  
(206) 685-1331

# CONTENTS

## **Fishery Description**

Introduction  
Location of registration sites  
Regulations  
Registration

## **Gear Description**

### **Gear To Be Provided By ODFW/UW**

Manual longline reel	Carabiner snaps
Replacement spools	Plastic gangion snaps
Ground line	Fish hooks
Rigging tool and line sleeves	Plastic beads
Anchor snaps	Hookboards

### **Gear That Fishermen Will Provide**

Boat	Anchors
Cooler	Corks
Buoys	Tackle Box
Buoy lines	

## **Gear Assembly**

Mending and modifying ground line	
Gangions	Cork-snaps
Anchor-snaps	Buoy lines
Buoy-snaps	Ground line spool holder

## **Longline Reel Installation**

Methods Used In 1990  
Construction of Hookboard Holder

## **Deployment of Gear**

## **Past Research**

# FISHERY DESCRIPTION

## Introduction

During the summer of 1991 (May 1 to September 30), Oregon Department of Fish and Wildlife (ODFW) will initiate, manage, and monitor a Tribal **longline** fishery for northern squawfish in the Zone 6 commercial fishing management area (Bonneville, The Dalles, and John Day Reservoirs).

The University of Washington (UW) will be responsible for outfitting qualified fishermen with a **longline** gear package and providing technical advice as needed throughout the summer for all fishermen.

ODFW seasonal employees will observe the activities of randomly selected Tribal fishermen, collect and verify various catch and effort data and issue a voucher paying \$4.00 for each northern squawfish **harvested** that measures eleven inches or more in length, was caught under set Tribal **Longline** Rules and Regulations and is in premium condition.

## Location of Registration Sites

The registration sites will be located at the Bingen Marina (Port of Klickitat) boat ramp on the Washington shore and at the Port of Cascade Locks boat ramp on the Oregon shore of Bonneville Reservoir. A single registration site will be located at the Celilo Park boat ramp in The Dalles Reservoir. And registration sites will be located at Le Page park boat ramp and Umatilla Marina boat ramp on the John Day Reservoir. Look for ODFW vans marked: Tribal Longline. ODFW employees will operate at these sites **Wednesday through Sunday, 7 a.m. until 9 p.m.**

## Fishery Description

# Regulations

## Location

Except for Boat Restricted Zones around the dams, Tribal **longline** fishing is permitted throughout Bonneville, The Dalles, and John Day Reservoirs.

## Gear Specifications

Longlines --There are no current length restrictions on ground lines, however, it is recommended that lines are no longer than 1200 feet. Each line must be marked with a buoy at each end in order to minimize conflict with recreational fishers and barge traffic.

Buoys -- Buoys must be colored **florescent** green or yellow, measure at least one foot in diameter, and bear the tribal enrollment number of the participating fisherman. This number must be at least four inches tall and clearly visible.

**Gangion** Lines -- **Gangion** leaders can be no stronger than 30 lb breaking strength monofilament line in order to insure the escape of larger fish that are not squawfish, such as sturgeon and catfish.

Hooks -- Only non-stainless steel hooks size **3/0** are permitted in the Tribal **longline** fishery. The hooks must therefore be attracted to magnets. Non-stainless steel hooks rust out of fish quicker than stainless steel hooks. Smaller hooks are swallowed more easily and the prohibition of larger hooks will minimize injury and mortality rates of small sturgeon and non-squawfish species.



## **Bait**

Any kind of bait, except for live bait, is permitted in the Tribal longline fishery. Some salted salmon smolts will be provided in order to supplement the fishermen's bait supplies, as that bait is made available to UW. This bait is being furnished through the help of C.R.I.T.F.C. and will be given away on a first come, first serve basis in quantities adequate for one week of fishing.

## **Incidental Catch (Non-Squawfish)**

All incidental catch has to be reported in the Tribal fisherman's log books. The log books will be provided by ODFW. All species other than northern squawfish are to be immediately released unharmed.

## **Registration**

The fishermen will be required to provide information about the time and location of setting the longlines to ODFW personnel at one of the registration sites.

Prior to pulling the longlines, the fishermen must check in with ODFW personnel at one of the registration sites. In this way an ODFW observer can be randomly placed aboard any participating fisherman's vessel before that fisherman pulls his gear. **Fishermen will not be allowed to register their catch, nor will they be paid for their catch, if they do not register before pulling the longlines.**

The longlines have to be pulled between 8:00 am and **8:00** pm on the day of or the day after they were set. No **longline** fishing gear will be allowed to **fish** or remain in the river over Mondays or Tuesdays.

## Fishery Description

### Registration (Continued)

The fishermen will be required to deliver their catch to the same registration site where they registered to pull the longlines: This enables ODFW to gather information about any given set of longlines (location, effort, success, etc.) on one registration form at one registration site.

Along with their catch, the fishermen are required to turn in the carbon copies of their completed log book entries.

ODFW personnel will measure the northern squawfish and verify the number of fish that are in premium condition and over 11 inches total length. ODFW will issue a voucher paying \$4.00 per qualified fish.

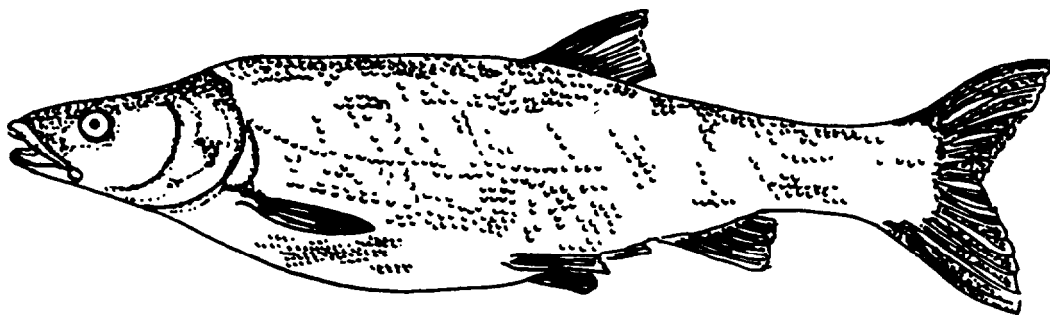

**Northern Squawfish (*Ptychocheilus oregonensis*)**

# GEAR DESCRIPTION

The **longline** gear that is **being** supplied by UW is designed to be quickly assembled and disassembled. It is built in easy to handle pieces and upon assembly, can be quickly set or retrieved.

It is not the only allowable **longline** for participating in this Tribal **Longline** Fishery, however, any longlines used must follow the regulations put forth at the beginning of this manual.

## Gear To Be Provided By ODFW/UW

The equipment that will be supplied to the participating fishermen will be their property. It will be **their responsibility** to maintain or repair any gear. Once they have received the gear, neither ODFW nor UW is responsible for replacing or repairing lost or broken gear.

If a fisherman decides not to use any of the gear provided, however, it can be returned to the University of Washington and distributed to another Tribal longline fisherman.

### Manual Longline Reel

Lightweight manual **longline** reel with drag control and free spooling features. This reel can also be purchased with an electric motor, but this will not be supplied by the UW.

Boom length	32"
Total height	69.5"
Height to center of spool	44.5"

Vendor: Custom Sea-Gear

Contact: Al Hawver

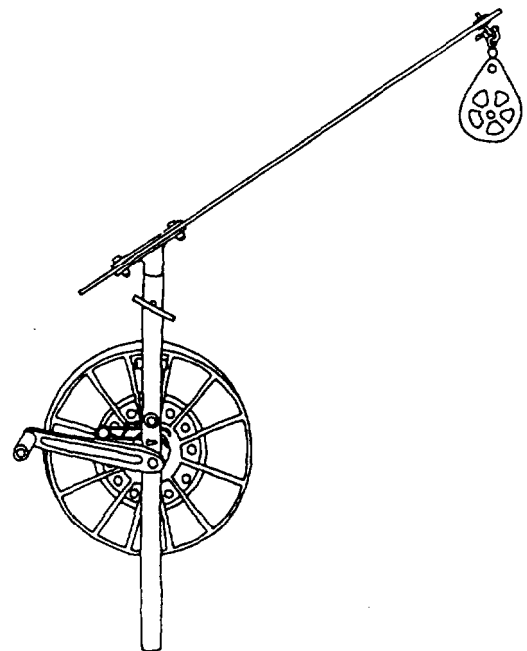

The use of brand name **items** does not imply endorsement **by the federal** government. For further information, contact the authors.

## Replacement Spools

Heavy duty spools hold 1200 feet of 250 pound test monofilament ground line.

Outer diameter	13.5"
Inner diameter	9.5"
Width	2.5"
Hole diameter	7/16"

Vendor: Custom Sea-Gear

Contact: Al Hawver

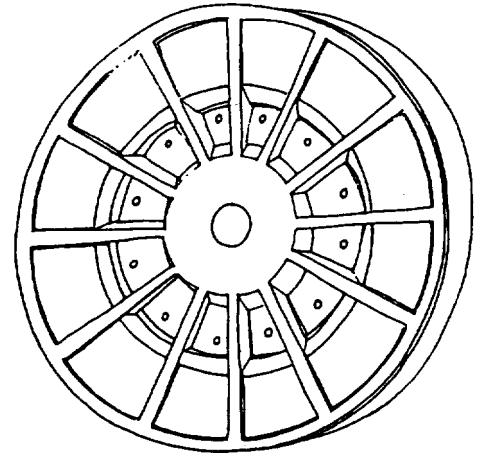

## Ground Line

250 pound test soft monofilament line with brass bead stops every 3 feet.

Line - 0.067" (1.7 mm) dia.  
Brass stops - >0.1575" (4 mm) O.D.

Vendor: International Longline  
Supply

Contact: Eric Jensen

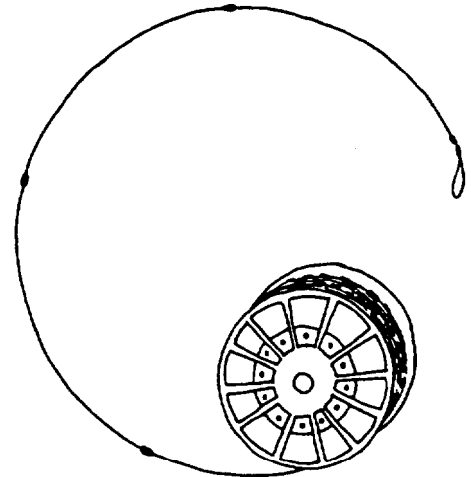

## Rigging Tool and Line Sleeves

For re airing or modifying monofilament ground line. Standard multi-groove crimping tool with side cutters used by trollers and longliners.

Line sleeves: Size A-I 2

Vendor: Available at most commercial fishing stores used by commercial salmon trollers.

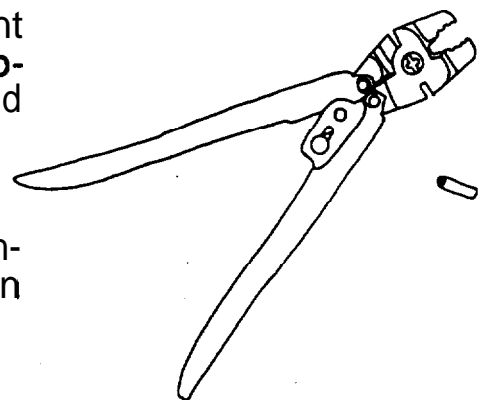

The use of brand name items does not imply endorsement by the federal government. For further information, contact the authors.

### Anchor Snaps

Steel wire gangion snaps designed for small diameter ground line. Strong and efficient enough for use with anchors.

“Halibut” style, size 1/4 inch.

Vendor: Available at most commercial fishing stores used by commercial salmon trollers or longliners.

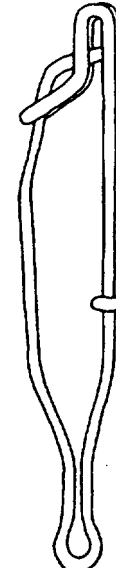

### Carabiner Snaps

Medium size (5/16”) carabiner snaps for quickly attaching buoys to buoy lines.

Small size (1/4”) carabiner snaps for attaching lengths of ground line on spools.

Vendor: Available at most commercial fishing stores.

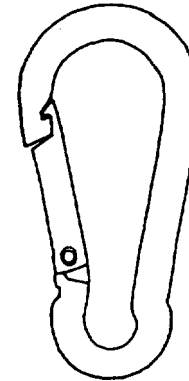

### Plastic Gangion Snaps

One-piece molded plastic longline gangion snaps.

Height	2.0”
Width	0.5”
Thickness	0.25”
Gap	0.04 - 0.055”

\*Vendor has the only mold.

Vendor: International Longline Supply



Contact: Eric Jensen

## Fish Hooks

3/0 Kahle horizontal fish hooks. Nickel or bronze plated "up-eye" hooks.

Eagle Claw Style  
145 - Nickel plated  
144 - Bronze finish

Vendor: Eagle Claw

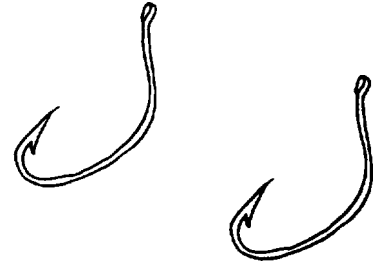

Contact: Gene Wilson

## Plastic Beads

Small plastic beads for longline gangions with hole through middle large enough for gangion leader to go through.

This allows for the hook to swivel on the gang ion.

Size - #6

Vendor: Available at most commercial fishing stores used by commercial salmon trollers or lure makers.

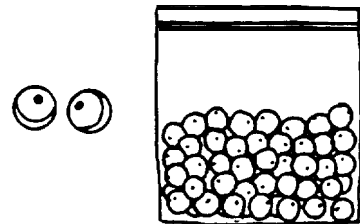

## Hookboards

16" x 24" plastic sheets with polyethylene ribs. A 1/8" soft plastic ridge is attached to each rib with slots cut every 1/2" for holding monofilament gangions.

Vendor: Specialty item made by University of Washington.

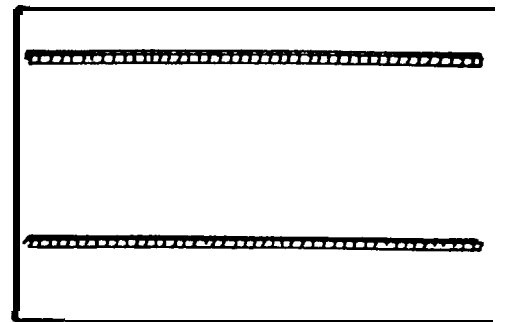

## **Gear That Fishermen Will Provide**

In addition to the gear package supplied to each fisherman, the following gear will also be necessary for fishing the UW style longline system.

### **Boat**

Each fisherman that receives gear must have use of a boat for the summer, 16 feet or longer with enough space for 3 people and appropriate longlining gear. The motor should be in a good, operable condition. An open bow is highly suggested.

The boat should also conform to major Coast Guard regulations and when fishing at night, navigational lights should be considered. Most marine supply stores sell suction cup flashlights with red and green lenses for less than \$15.

### **Cooler**

Each fisherman must have some method for handling their catch and maintaining a premium quality product in order to receive their bounty. Also, you will need some method for handling whatever bait you choose to use. The fresher the bait, the better it will work! Mushy or spoiled bait doesn't work well for squawfish. Plan on using 1-3 bags of ice per day for your bait and squawfish.

## Buoys

Must be large enough to be seen from a distance and painted florescent green or yellow. They are also required to have a 12" diameter and display your Tribal **longline** certification number in 4" numbers.

You can buy buoys:

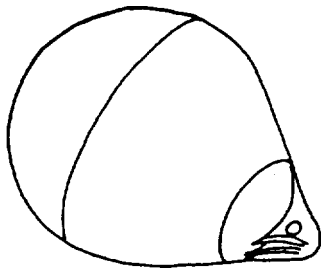

A-I polyform

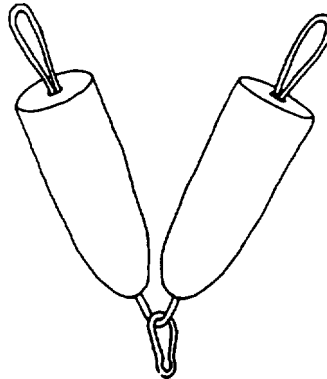

Bullet floats  
(must use at least two)

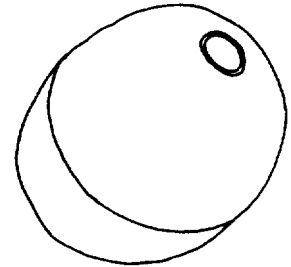

Styrofoam floats

Or you can make them:

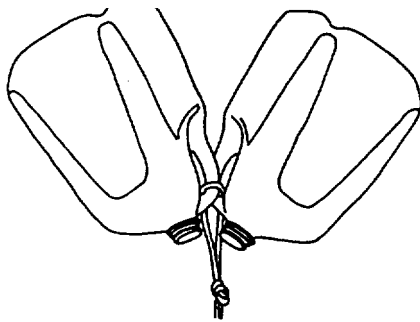

Painted milk jugs

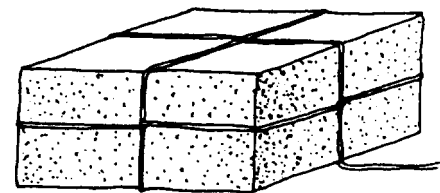

Styrofoam chunks

There are many other possibilities; use your imagination.

## Buoy lines

Buoy lines can be pre-cut to similar lengths in order to speed up setting longlines. We suggest **5/16"** poly holobraid rope **which** is available at most marine or commercial fishing stores. See Gear Assembly for more details.



## Longline Anchors

Any 5-10 pound weight will work for this longline. Sometimes a few 15-20 pound weights are nice to have when in high current areas. We suggest **inexpensive**, disposable weights since weights can get hung up on the bottom and lost.

Suggestions:

Any Metal Object  
With a Hole for  
Tying on a Snap

Or:

Window  
sash  
weights



Tractor  
weights

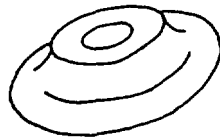

Lead-filled  
pipe



Bricks

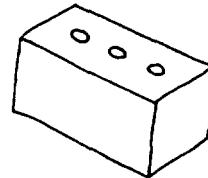

Bag of rocks



Other scrap metal: old brake drums, backhoe teeth, cut sheet metal, etc.

The best shape of anchor for rip-rap material is long and skinny, whereas for sandy-muddy bottom, a wider flatter shape seems to hold better.

## Corks

Corks can be used to control the depth that the longline is fishing. Past research has shown that the squawfish do not always hang out on the bottom so it is beneficial to float the longline off of the bottom.

Old gillnet corks work just fine.

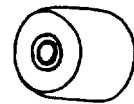
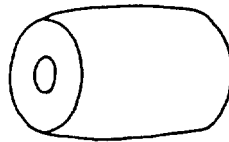

## Tackle Box

A tackle box should always be carried while fishing this longline that contains the following items:

- Rigging tool and line sleeves
- Side cutter pliers
- Hook removers or needle nose pliers
- and a knife.

# GEAR ASSEMBLY

The following methods are suggested for assembling your longline gear.

## Mending and Modifying Ground Line

### Modifying --

If you wish to change the length of your longlines, simply use the rigging tool and line sleeves to make 2 - 3 inch loops at each end of the line. Use a small (1/4") carabiner snap to connect longlines on the spools.



### Mending --

When mending a cut or broken line, use small loops and splice the two pieces together.



When mending or modifying these longlines, use two line sleeves at each spot in order to guarantee the strength of the splice. These should have at least 1/4" gap between them.

## Gangions

The length of the gangions is extremely important for handling your hooks. If they are too long they will snag everything in sight, and if they are too short they will not fit on the hookboards.

### Tying hooks to the leader --

The first step is to tie a hook on to a length of leader that is no stronger than 30-lb breaking strength. Leave a minimum of 1 foot of leader length.

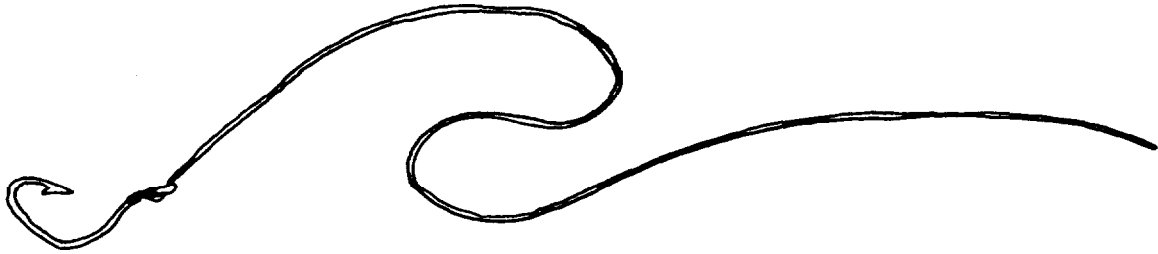

### Tying snaps to the leader --

Next thread a plastic snap and bead onto the leader material.

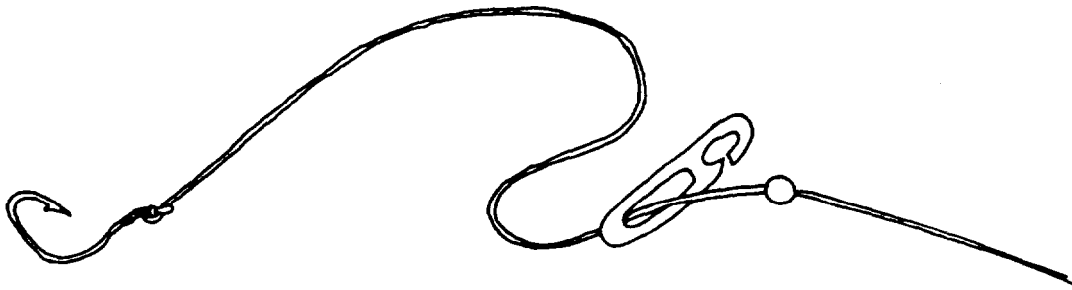

Then tie an overhand knot roughly 11 inches from where the leader is tied to the hook.

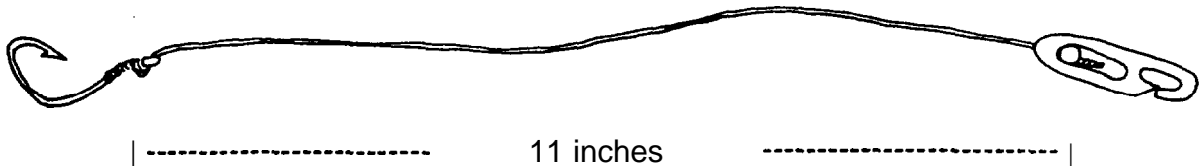

Be sure to trim the extra leader extending from the knot to 1/4" so that the swivel mechanism works on the snap.

## Anchor-Snaps

It is best to attach the snaps to the anchors with a heavy gauge metal wire. This prevents any rough edges on the anchors from cutting the connecting line.

5-gallon buckets or small wooden crates work best for organizing and containing your anchors on the boat.

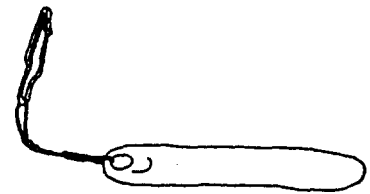

## Buoy-Snaps

Buoy snaps should be attached with a line in such a way that there is roughly 8 to 10 inches of line between the snap and the buoy.

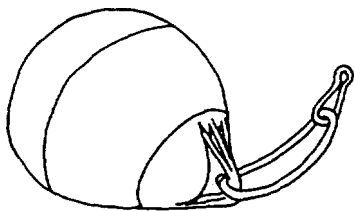

or

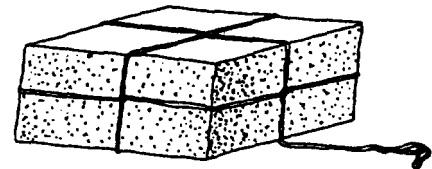

## Cork-Snaps

Tie small one piece plastic snaps to each cork so they can be placed in the mid-section of a longline, thus **controlling** the depth at which the **hooks** are fishing. See Gear Deployment Section.

Corks can also be organized using 5 gallon buckets.

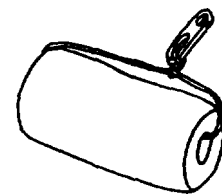

## Buoy Lines

Cut lengths of 5/16 inch poly holo braid line (or any other line) to 15, 30, and 60 feet lengths with a loop in either end. Put one medium sized (5/16") carabiner snap on each buoy line.



Since this gear is not usually set in the exact same location and depth each time, you will be prepared to fish at all depths. These lines can then be organized by hanging them from a suspended rope along the gunnel of your boat.

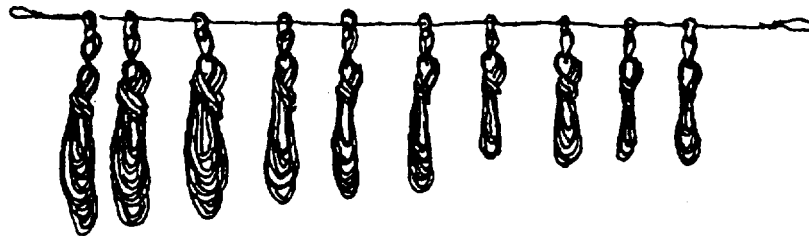

## Ground Line Spool Holder

It is helpful to have a method for handling the extra spools of ground line. A small box with a handle is relatively simple to make.

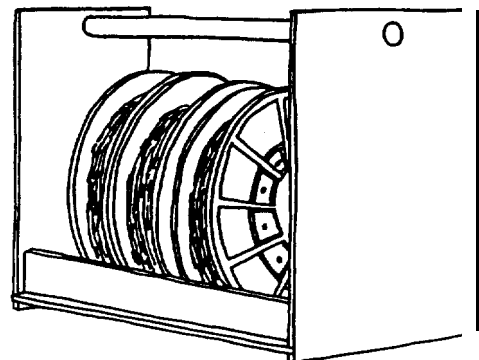

# LONGLINE REEL INSTALLATION

Proper placement of the longline reel on your boat is crucial. The most effective way to fish this longline system is to use two people. One operates the boat and the longline reel while the second person snaps the gangions, buoys, and anchors on or off the ground line.

## Methods Used In 1990

Center Console:

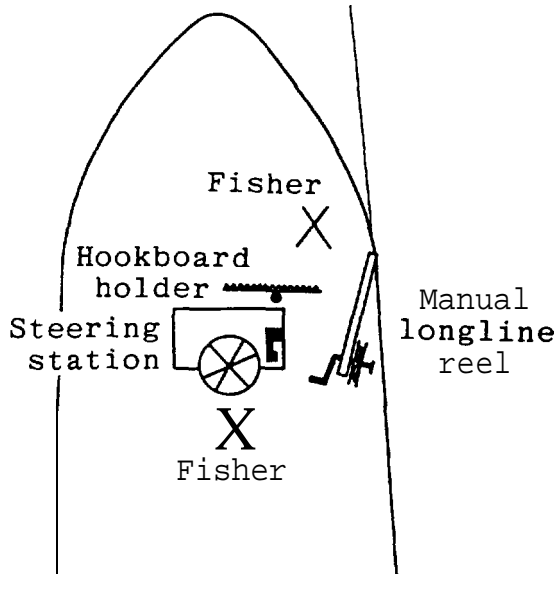

Side Console in Middle of Boat:

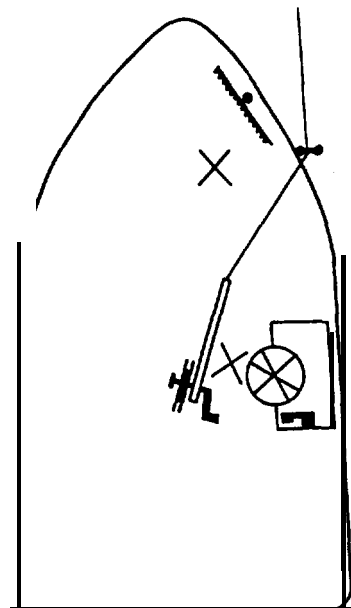

Side Console Towards Bow of Boat:

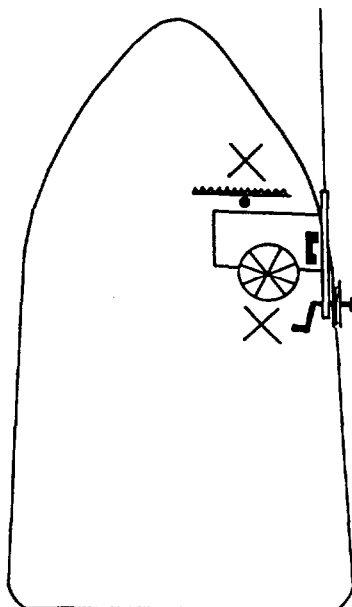

Side Console Towards Stern of Boat:

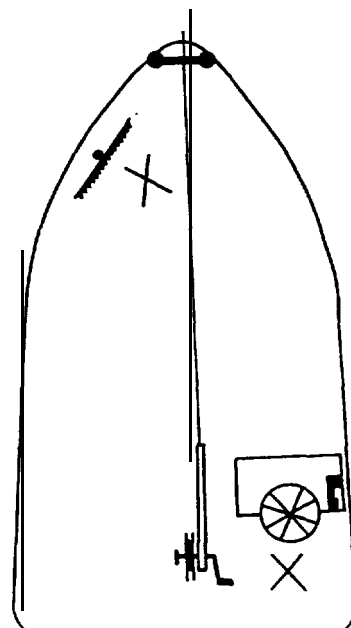

## Construction of Hookboard Holder

Hookboard holders can be made several different ways. The easiest to use is a three sided rack made out of 1/2" three sided angle aluminum (channel).

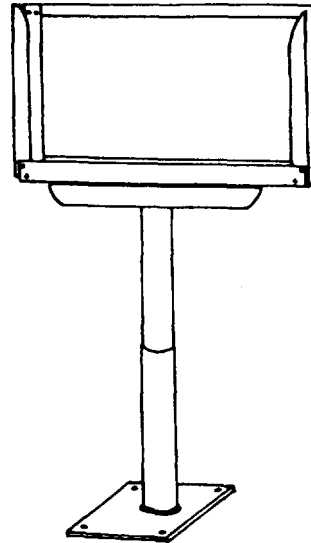

Another method is to drill holes in the hookboards and hang them from a two pronged rack made from water pipe.

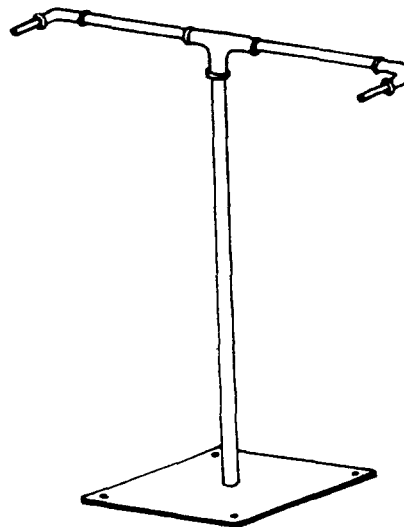



# DEPLOYMENT OF GEAR

The best way to set this gear is to point the boat upstream and work the gear with the current (not across the current). Drop the first anchor with the buoy attached and back away downstream. As the ground line goes out attach gangions every 10-12 feet. Use the motor while setting and pulling to control boat speed. **This longline is not strong enough to pull your boat upstream against the current, something will eventually break if you do this.**

Setting gear:

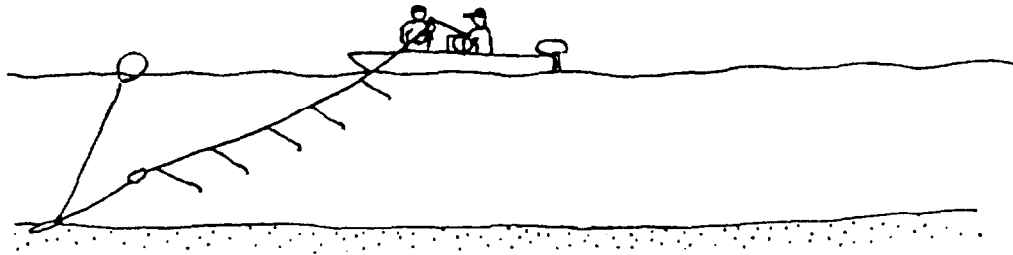

=> => => Current => => =>

As the ground line is let out, corks or anchors can be attached in order to control the depth that the gear is fishing. When the end of the ground line is reached, attach **another** anchor with a buoy line and buoy attached and drop the anchor in the water.

DO NOT TRY TO SET THE GEAR TOO FAST IF YOU HAVE NOT DONE LONGLINING BEFORE OR YOU WILL GET HOOKS IN YOUR HAND OR MAYBE EVEN YOUR EYE.

Following are a few of the many possible ways to control at what depth your hooks are fishing.

No Corks:

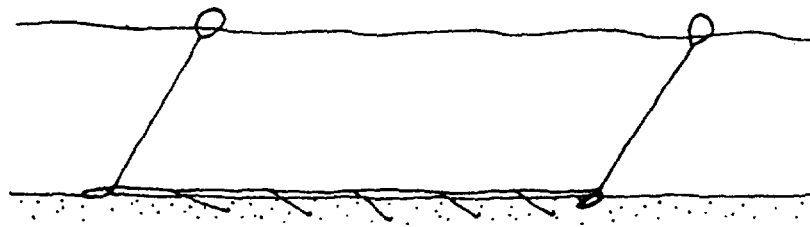

(On Bottom)

Small Corks:

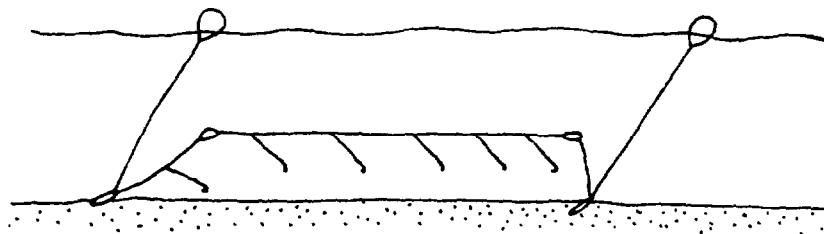

(Mid-Water)

Big Corks:

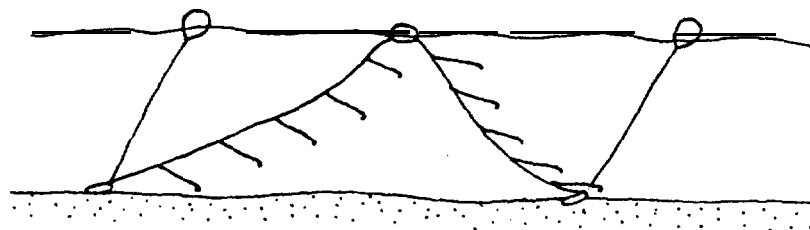

(Throughout the Water Column)

# PAST RESEARCH

## Hooks

In 1989 we compared several different hook types. The two best hooks are the 3/0 steelhead and the 3/0 Kahle horizontal (English Bait) hooks. Both are easy to bait and debait and are easily sharpened. However, once they have been sharpened a number of times, they do tend to rust and should be replaced.

The size of the hook is very important. We discovered that the 3/0 hooks consistently caught as many squawfish as the smaller hooks did. Smaller hooks are swallowed more often and are more apt to injure sturgeon and catfish. Larger hooks damage incidental catch as well by cutting gills and poking out eyeballs. We also found the 3/0 size hooks easier to bait and debait.

The Kahle horizontal hook is potentially the best hook. In tests against the steelhead hook the Kahle design caught 1.5 times as many squawfish. In these tests, longlines were set with 50% Kahle hooks and 50% steelhead hooks and all hooks were baited with salmon smolts. A total of 412 hooks of each type was fished; the Kahle hooks caught 78 squawfish and the steelhead hooks caught 51.

## Hook Spacing

In 1990 we compared different hook spacings to determine if setting more hooks per line would actually allow us to catch more fish. We found our catch rates to be nearly equal when hooks were spaced 6 feet apart (50 hooks per line) and 12 feet apart (25 hooks per line). This told us that we were wasting effort by setting too many hooks per line. Of course this will depend on the number of fish in an area, but we decided that setting hooks every 12 feet and setting more lines was more productive than setting fewer lines with hooks set every 6 feet.

Also by setting more lines you can cover a larger area in finding the dense populations of squawfish. Once you find a school, it may be wise to set more hooks per line and focus your effort in one particular area.

## Depth Distribution

It is relatively easy to control the depth that the hooks are fishing on this **longline** by adding corks or anchors while you set the gear. In 1989 we determined that squawfish were distributed throughout the water **column**. We caught as many squawfish on lines that reached the surface of the river in the middle of the line as we did on lines that stayed on the bottom of the river throughout their length. The incidental catch of sturgeon and catfish **drastically** increases on lines that are strictly fished on the bottom of the river.

In 1990 we observed that squawfish catch rates were better when fishing on the bottom of the river early in the season, and later in the summer the fish were caught effectively throughout the water column.

We encourage **trying** different methods. If you keep the hooks off the bottom, fewer **catfish** and sturgeon will be caught.

## Time of Day

The best time of day for capturing squawfish seems to be in the early and late evening (5 p.m. - 12 a.m.) and the early and late morning (3 - 6 a.m. and 9 a.m. - 12 p.m.) Catch rates are very low during the afternoon.

## Bait Selection

Many bait types have been investigated over the past two years of research. In the following table for 1990, all baits were fished on the same day, in the same locations, at the same times, and on the same style of hook for each comparison. Normally the baits were alternated on each line in order to give the squawfish a choice of food. The results are listed from best to worst as compared with Large whole salted smolts.

Comparisons with Large Salted Smolts as the Control.  
All Comparisons Were Fished on the Same Day.

Bait	Hooks	Squawfish	Hooks/ Squawfish
Large whole salted smolts	240	18	13.33
<b>Lamprey ammocoetes</b>	144	21	6.86
Large whole salted smolts	384	11	34.91
<b>Fresh sand shrimp</b>	384	20	19.20
Large whole salted smolts	144	18	8.00
<b>Fresh whole smolts</b>	38	8	6.00
Large whole salted smolts	94	8	11.75
<b>Small yoy shad</b>	95	10	9.50
Large whole salted smolts	288	22	13.09
<b>Small whole salted smolts</b>	240	17	14.12
Large whole salted smolts	860	69	12.46
<b>Salted smolt pieces</b>	980	46	21.30
Large whole salted smolts	144	18	8.00
<b>Frozen fresh smolts</b>	48	2	24.00
Large whole salted smolts	60	0	N/A
<b>Adult lamprey pieces</b>	144	1	144.00

## **Suggested Places to Set Gear**

When setting this gear, we suggest looking for current shears where a fast current meets with a slow current (such as the outside edge of an eddy). However, squawfish are found in any given area depending on water flow, water temperature, and the time of year. Don't hesitate setting gear in unsuspecting areas, you may hit a jackpot.

To be successful at this fishery, you will have to experiment and adapt throughout the entire summer. Just when you think you have found the trick to catching squawfish, something better will come along or the squawfish will suddenly disappear.

Good Luck and Happy Fishing!



Appendix 1.3. In-season progress report for the 1991 tribal **longline** fishery for northern squawfish in the Columbia River.



Oregon Department of Fish and Wildlife  
Northern Squawfish Tribal Longline Fishery

Fisher's In Season Progress Report

Fisher's Name \_\_\_\_\_ Tribal #: \_\_\_\_\_

Phone #: \_\_\_\_\_

We are concerned about the northern squawfish tribal **longline** fishery implementation and **have** recognized that fishermen's **participation is lower than** expected. We value your opinion and suggestions highly and would like to ask you a number of questions in order to evaluate the current implementation of this fishery. This would enable us to adjust where **possible** and necessary to improve the overall **situation**. We hope that our efforts **will** encourage you and your fellow **fishermen** to participate in this fishery more **frequently**,

How do you feel about using **longline** gear to catch squawfish?

Do you think the amount of gear and bait we issue **is** sufficient?

What kind of **bait** do you use and why (most effective, least expensive. **etc...**)?

Do you think the help and guidance we provide with the **longline** gear **is** sufficient?

What are the reasons **for** low catch rates using **longline** gear?

Do you think another type of commercial gear would be more effective?

How do you feel about the fishing season (May 1 through Sept. 30) and the day and time restrictions (Wed- through Sun, . 7 a. m. through 9 p. m. )?

Is the reward of \$4 per squawfish an adequate reimbursement for your efforts or would you rather see another form of incentive?

Our program intends to decrease the number of predacious squawfish that teed on young salmon and steelhead, By accomplishing higher survival rates during the downstream migration. we will see higher salmon and steelhead returns to the spawning grounds in 3 Lo 5 years- 1 hus- every squawfish caught today will improve salmon fisheries in the near future.

What are the reasons for the low tribal participation in the commercial part of our program?

Are there any other cultural aspects we didn't consider (pow-wows. recent deaths. etc. . . ) that kept you from longlining for squawfish?

Interviewer' s Comments:

Date:

Interviewer :



Appendix 3.1. Review of National Marine Fisheries Service data sheets from Merwin trapping and purse seining in the Columbia and Snake Rivers, **1973-1975.**

REVIEW OF DATA SHEETS AND REPORTS FROM NMFS  
MERWIN TRAPPING AND PURSE SEINING

BY

Brian Mahoney

In May of 1991 the University of Washington installed a Merwin trap in the cul-de-sac area of The Dalles Dam- This unit being essentially the same as that described by Hamilton et- al. (1970). Utilizing a work crew of three men. a total of 4,206 northern squawfish (Ptychocheilus oregonensis) were caught from May 26 to September 15, 1991. During this first fishing season modifications were made to the trap in order to increase efficiency.

The primary advantage of utilizing Merwin traps for the removal of squawfish is that the traps operational costs and required man hours are significantly lower than other removal methods such as sport angler bounty. and dam angling. The greatest disadvantage associated with the trap is found in its limited range of operational areas. Strong river currents. steeply pitched river banks, and limited access points restrict where and when a trap may be fished. A review of previous uses of Merwin traps on the Columbia and Snake rivers was undertaken with the intention of locating potentially successful squawfish trapping sights.

Bentley et. al. (1976) used Merwin traps to sample squawfish populations in the Columbia and Snake rivers from December 1973 to August 1976. Their- focus on squawfish was

directed towards squawfish success as a predator on migrating Juvenile salmonids in the Snake River and what effects the presence of excess dissolved gasses played in predation **efficiency**. We have reviewed their data sheets and their three reports hoping to discover where and when Merwin traps could be most effectively fished on the Columbia and Snake **Rivers**.

Merwin traps were fished on the Columbia River in the Dalles Dam **forebay** from April through **July, 1975** (Bentley et- al. 1976). A total of 619 squawfish were caught, A second trap was fished in the **forebay** of the **John** Day Dam from April through October, 1975 taking 398 squawfish- **In** 1961 Lemier and Mathews fished a trap in the cul-de-sac below The Dalles **Dam**. This trap operated from July 27 to September 7 collecting 7.828 squawf **ish**. The **forebay** areas of a dam possess moderate current flow allowing for easy operation of a trap- However, the low catches rates in the **forebay** areas may prevent them from **being** chosen as a work **sight**.

Bentley operated two traps in the Snake **River**. **One** trap was fished in the **Palouse** Arm of Lower Monumental Reservoir at Lyons Ferry, Washington and the other trap was located in the mainstern of the Snake River at Levey Landing, 92 km downstream from Little Goose Dam (Figure **A1**).

The traps were fished -from April 1973 through August 1976 and proved to be very successful at catching **squawfish**.

The trap at Lyons Ferry took a **total** of **34,607** squawfish in four years. while the Levey Landing trap totaled 51,775 squawfish during a three year run- The University of Washington trap in The Dalles Dam cul-de-sac fished from May 26 to September 15. 1991 catching 4,206 squawfish in its first year of **operation**.

These three traps exhibited different seasonal peaks in catch rates (Figure **A2**, Table **A1**). In 1976 the Lyons Ferry trap catches were highest from the week of April 25 through the week of June 12, peaking with 2,345 squawfish caught during the week of May **15**. The 1976 Levey Landing trap showed high catch rates from June 6 thru August **28**, peaking with 2,146 squawfish during the week of **July 10**. The 1991 Dalles Trap catch rates were high from June 9 thru **July 7**. **the** peak catch was over the week of **June 30**; 911 squawfish were **caught**.

In the spring and early summer. during the time of high river flow and spillage at the dams. Bentley found that large numbers of squawfish were concentrated in **the Palouse** Arm in order to escape the high levels of dissolved sasses in the Snake **River**. Bentley purse seined in the tail race below Little Goose Dam- Low numbers of fish, **11.7** squawf ish per set. were taken while the level of total dissolved gasses were high ( > 117% total dissolved atmospheric gasses)-

When the spill over the dam ceased and the dissolved **gas** saturation levels returned to normal, catch rates at the

Lyons Ferry trap site decreased while catch rates in the seining operation **increased**. During five days of seining 1.935 squawfish (or **161.2** fish per set) were taken. All of the squawfish taken in the seine showed evidence of feeding heavily on lamprey ammocetes, Entosphenus tridentatus (Bentley 1976).

Our operation of one Merwin trap fished seasonally at The Dalles Dam could be successfully expanded to include two additional trap sites; one at Levey Landing and one at Lyons Ferry in the **Palouse** Arm (Table **A2**).

The Dalles trap should be in operation from May through **September**. The Lyons Ferry trap should be open from April through July. The Levey Landing trap should operate from mid-April through mid-September--

If only two traps were in operation for the 1992 season The Dalles trap should operate **from** May through **September**. The second trap should begin operations at the Lyons Ferry site fishing from April **until** mid-May and then be moved to the Levey Landing site to fish from June until **mid-September**. In considering any additional purse or beach seining. the **tailrace** area of the Little **Goose** Dam from mid July through mid-August. or at such time as when gas saturation levels are reduced. may prove **effective**.





## LITERATURE CITED

- Bentley, W. W. , E. M. Dawley, and T. W. Newcomb. 1975. Some Effects of Excess Dissolved Gas on Squawfish. *Ptychocheilus oregonensis* (Richardson ), p. p. 41-46 in D. H. Fickeinsen and M. J. Scheider (eds. ), Gas Bubble Disease : Proceedings of a workshop held at Pichland. Washington Oct. 8-9, 1974. Energy Res. Div. Admin. Office of Public Affairs. Tech- Inf. Center. Oak ridge. TN.
- Bentley. W. W. . E. M. Dawley. 1981. Effects of Supersaturated Dissolved Atmospheric Gasses on Northern Squawfish. *Ptychocheilus oregonensis*. Northwest Science. vol. 55, no- 1. 1981..
- Hamilton, J. A. R. , L. O. Rothfus. M. W. Erho. and J. D. Remington. 1970. Use of a Hydroelectric Reservoir for the Rearing of 'Coho Salmon (*Oncorhynchus Kisutch*). Wash- Dept. Fish-. Res. Bull- 9:65 pp.
- Lemier, F. H. , and S. B. Mathews- 1962. Report on The Developmental Study of Techniques For Scrapfish Control. Wash, Dept. Fish- unpublished.
- Sims, C. W. , R. C. Johnson. and W. W. Bentley.. 1976. Effects of Power Peaking Operations on Juvenile Salmon and Steelhead Migrations. 1975. NOAA. NMFS, Northwest Fisheries Center, Seattle, Washington. Progress Report to U. S. Army Corps of Engineers.
- Sims, C. W. . R. C. Johnson, and W. W. Bentley- 1977. Effects of Power Peaking Operations on Juvenile Salmon and Steelhead Migrations, 1976. NOAA. NMFS. Northwest Fisheries Center, Seattle, Washington- Progress Report to U. S. Corps of Engineers.

Table A1

Comparison of Weekly Mervin Trap Catches

Lyons Ferry  
(Palouse Arm, 1976)

Date	Totals
4/18-4/24	115
4/25-5/1	652
5/2-5/8	1568
5/9-5/15	2345
5/16-5/22	356
5/23-5/29	1242
5/30-6/5	872
6/6-6/12	665
6/13-6/19	488
6/20-6/26	611
6/27-7/3	408
7/4-7/10	296
7/11-7/17	256
7/18-7/24	154
7/5-7/31	
8/1-8/7	
8/8-8/14	
8/15-8/21	
8/22-8/28	

<b>Total</b>	<b>100281</b>
--------------	---------------

Levey Landing  
Mainstem of Snake River, 1976

Totals
6
435
917
966
174
605
891
1770
1314
887
1698
2146
1165
1253
1222
1190
1480
1052
814

<b>19985</b>
--------------

The Dalles  
Cul-de-sac, 1991

Date	Totals
-	-
-	-
-	-
5/26	19
6/2	29
6/9	620
6/16	427
6/23	751
6/30	911
7/7	216
7/14	224
7/21	82
7/28	146
8/4	156
8/11	222
8/18	127
8/25	NA
9/1	87
9/8	111
9/15	78

<b>4206</b>
-------------

∞

Table A2

Summary of Mervin Trap Catches

	Lyons Ferry (Palouse Arm)			Levy Landing (Mainstem of Snake River)		John Day For bay	The Dalles Forbay	The Dalles Cul-de-sac
	1973 Nov-Dec	1974 Jan- Dec	1975 Jan- Dec	1974 Oct-Dec	1975 Jan- Dec	1975 Apr-Oct	1975 Apr-Jul	1991 May-Sept'
SQUAWFISH	841	17969	5765	535	6113	398	619	4206
SALMONIDS	16	98	27	286	149	46	79	4707
OTHER FISH	7711	69434	26707	3037	21670	5382	6609	13349
<b>TOTAL FISH</b>	<b>8568</b>	<b>8750 1</b>	<b>32499</b>	<b>3858</b>	<b>27932</b>	<b>5826</b>	<b>7307</b>	<b>22262</b>

Figure A1

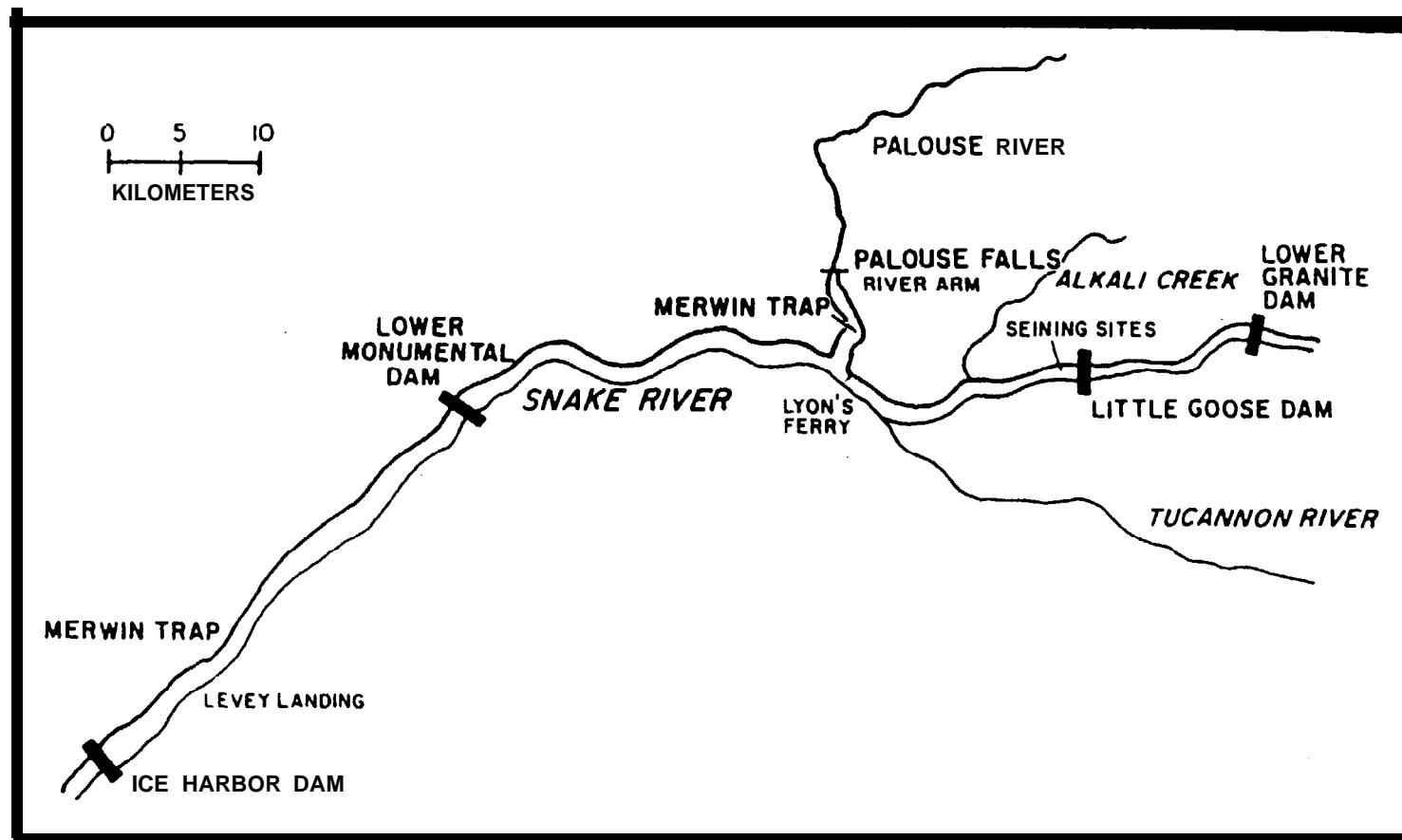
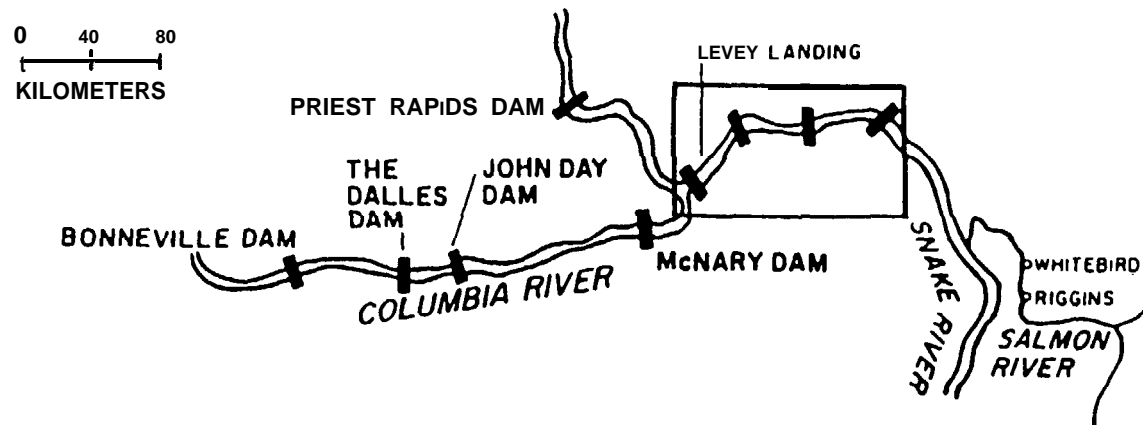
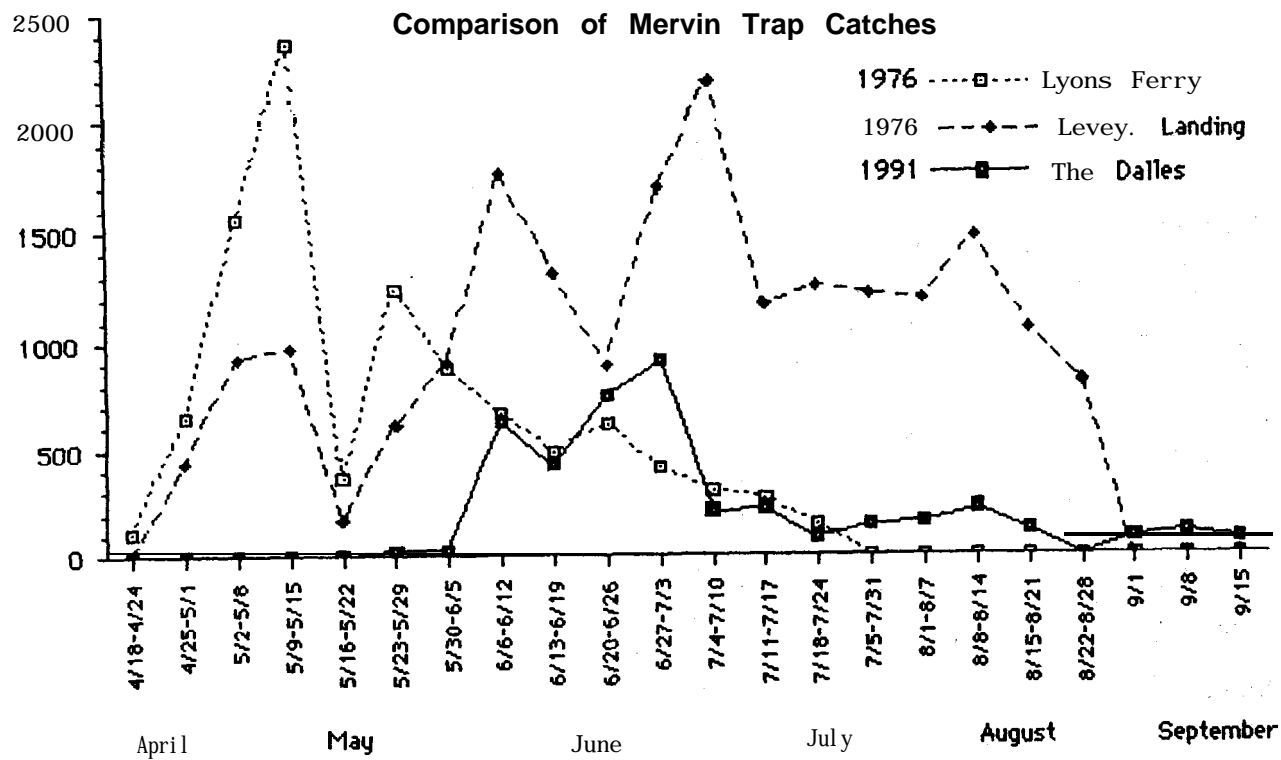

Figure A2



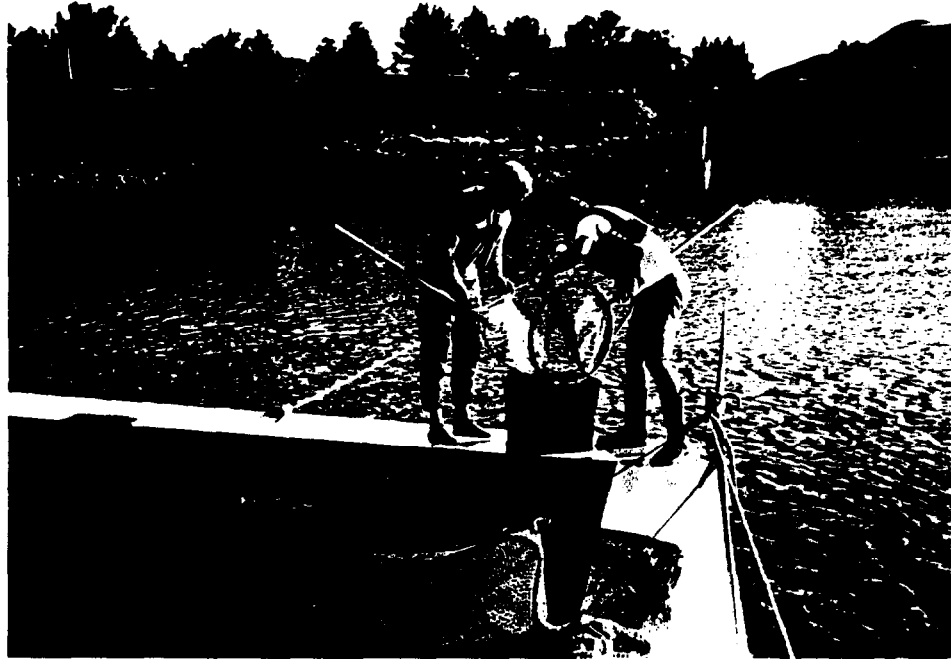

Plate 3. 9 **Removing fish** from spiller.

REPORT E.

Feasibility of Various Techniques for Removal of  
Northern Squawfish at Bonneville Dam,  
Columbia River

Prepared by

Bruce H. Monk, William D. Muir, and Paul Bentley  
Coastal Zone and Estuarine Studies Division  
Northwest Fisheries, Science Center  
National Marine Fisheries Service  
National Oceanic and Atmospheric Administration





CONTENTS

	<u>Page</u>
ACKNOWLEDGMENTS .....	291
ABSTRACT .....	292
INTRODUCTION .....	293
ELECTROFISHING GEAR.....	293
Methods and Materials .....	293
Results and Discussion .....	295
CONTINUOUS MULTI-LURE <b>LOGLINE</b> GEAR.....	300
Methods and Materials .....	300
Results and Discussion .....	302
PURSE SEINING.....	302
Background .....	302
Methods and Materials .....	302
Operating Conditions at Bonneville Dam First Powerhouse .....	302
Dates and Times of Seining .....	304
Purse Seines .....	304
Fishing Procedures and Fish Processing .....	306
Results .....	306
Discussion .....	309
CONCLUSIONS: ALL TECHNIQUES .....	309
REFERENCES .....	3 1 4
APPENDIX FIGURES .....	317
APPENDIX TABLES .....	321



## FIGURES

Figure **E-1**. Bonneville Dam First Powerhouse showing location of **wingwall** arrays, **piernose** arrays (Turbine Unit **10**) continuous multi-lure longline, and main areas for purse seining (shaded area).

Figure E-2. Electrofishing gear tested for harvesting northern squawfish at Bonneville Dam First Powerhouse, summer **1991**. Top, **wingwall** electrode array; middle, **piernose** electrode array; bottom, portable electrode array.

Figure E-3. The number of northern squawfish and subyearling chinook salmon stunned and captured per hour after electrofishing with permanently installed electrofishing gear at Bonneville Dam First Powerhouse **forebay**, 17 July to 20 August **1991**. Asterisks denote dates where the numbers of stunned fish were not recorded. Means and standard deviations are for the number captured per hour.

Figure E-4. Spill ( $\text{m}^3/\text{second}$  in thousands) at Bonneville Dam, July-August **1989-1991**.

Figure E-5. the number of northern squawfish captured per hour with continuous multi-lure **longline** at Bonneville Dam **forebay**, summer **1991**.

Figure E-6. Location of adult fish attraction/collection system, **forebay** wingwall, and trashrack cleaning cable at Bonneville Dam First Powerhouse.

Figure E-7. Purse seine boat in **tailrace** of Bonneville Dam First Powerhouse.

Figure E-8. Weekly catch of northern squawfish by angling in vicinity of Bonneville Dam First **Powerhouse**<sup>6</sup>, comparing temporal catch distribution to period of purse seine effort.

## TABLES

Table E-1. Sampling information for permanently installed electrofishing gear used at Bonneville Dam First Powerhouse, **1991**.

Table E-2. Purse seine catches of northern squawfish at Bonneville Dam First Powerhouse, **1991**.

Table E-3. Combined adult salmon counts for Bradford Island and Washington shore monitoring stations at Bonneville Dam during periods just prior to and during squawfish seining at the First Powerhouse.

## ACKNOWLEDGMENTS

We thank U.S. Army Corps of Engineers personnel at Bonneville Dam for their assistance and cooperation in conducting these studies. Special thanks to Tom Thorsen, Chief of Maintenance, and Ed **Willits**, Structural Foreman, for helping to coordinate research activities. Their respective crews were very helpful in alternating gate settings in the ice-trash sluiceway system and in eliminating obstructions to seining (bird lines, log boom, and **forebay** cables). We also appreciate the extensive effort by Portland District Corps personnel in the coordination necessary to obtain powerhouse shutdown and modifications of the bypass system, particularly efforts by Rudd Turner, Jim Kuskie, and Larry Beck.

We also thank David Smith and his crew from Smith-Root, Inc. for their efforts with electrofishing. Thomas Poe, Richard Nelly (U.S. Fish and Wildlife Service), Steven Mathews, Thomas Iverson (University of Washington), and David Ward (Oregon Department of Fish and Wildlife) assisted with electrofishing/beach seining.

## ABSTRACT

During **1991**, the National Marine Fisheries Service evaluated a variety of techniques to remove northern squawfish, Ptychocheilus oregonensis, from the Columbia River at Bonneville Dam. Purse seining and electrofishing with permanently installed electrical arrays were tested, as well as a portable electrofisher deployed by a boom truck, a boat electrofishing unit used in combination with a beach seine, and a continuous multi-lure **longline** device. None of these removal techniques proved effective. However, the late starting date, other removal programs in progress, and the high rate of water spill may have influenced the results.

## INTRODUCTION

Northern squawfish, Ptychocheilus oregonensis, have been identified as major predators of juvenile salmonids (Oncorhynchus spp.) in the Columbia River, accounting for most previously unexplained reservoir mortality (Uremovich et al. 1980, Poe et al. 1991, Rieman et al. 1991). Predation rates are especially high around dams, where predators concentrate and where disoriented juvenile salmonids are particularly vulnerable (Beamesderfer and Rieman 1991, Rieman et al. 1991, Vigg et al. 1991). In John Day Reservoir, Rieman et al. (1991) estimated that predators, primarily northern squawfish, consumed 14% of the juvenile salmonids entering the reservoir during April-August 1983-1986. At Bonneville Dam, Uremovich et al. (1980) estimated that 3.8 million or 11% of the downstream migrant salmonids entering Bonneville Reservoir were eaten by northern squawfish in the 1980 season. Investigators from the Coastal Zone and Estuarine Studies Division (CZES) of the National Marine Fisheries Service (NMFS) estimated the adult population of northern squawfish in the forebay of Bonneville Dam First Powerhouse to be 58,000 in 1989, based on studies concluded that year.<sup>1</sup>

To address this problem, the Bonneville Power Administration (BPA) is funding a "system-wide predator control program" with the Oregon Department of Fish and Wildlife (ODFW) as lead agency. One category of this program is harvest technology development, which involves designing and evaluating new techniques for northern squawfish removal. As part of the harvest technology program, NMFS tested three general techniques in the area of Bonneville Dam First Powerhouse from 17 July to 20 August, 1991 (Figure E-1). The following harvest techniques were used: 1) electrofishing gear, both permanently installed and portable, 2) continuous multi-lure longline gear, and 3) purse seining.

## ELECTROFISHING GEAR

### Methods and Materials

An electrofishing system, designed and constructed by Smith-Root, Inc.<sup>2</sup> for the forebay of Bonneville Dam First Powerhouse, was tested. The system consisted of three main components; a 60 kW diesel-powered alternator, a control and power distribution panel box, and various electrode arrays (specifications given in Appendix Table E-1).

A voltage selector switch on the alternator allowed voltage adjustment for maximum effectiveness with changing water conditions and electrode arrays. The available voltages were 208, 240, and 480 V, supplied in three-phase configuration, with the neutral connection isolated from the safety ground system. The control box provided on-off power switching with remote capability, metered output voltage from 0 to 500 V, and individual phase currents from 0 to 500 A. Power distribution was accomplished with three

---

<sup>1</sup> Benjamin Sandford, NMFS, CZES, 2725 Montlake Blvd. East, Seattle, WA 98112. Pers. commun., January 1991.

<sup>2</sup> Reference to trade names does not imply endorsement by the National Marine Fisheries Service.



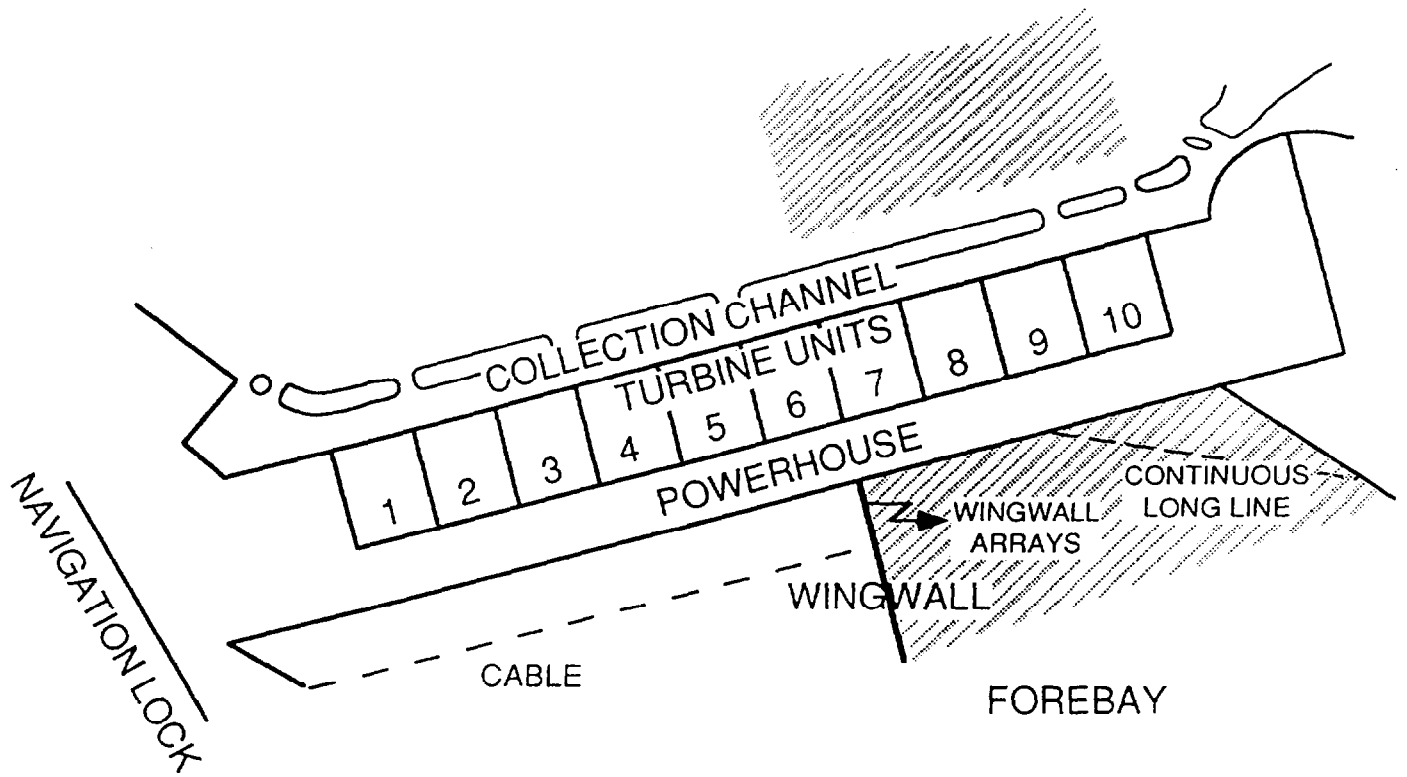

Figure E-1. Bonneville Dam First Powerhouse showing location of wingwall arrays, piernose arrays (Turbine Unit 10) continuous multi-lure longline, and main areas for purse seining (shaded area).

connectors, each providing the three phase voltages and a safety ground connection to the output arrays. A combination of any three arrays could be on at one time. Each output array was constructed with a safety-grounded supporting structure and three rows of cable electrodes, each connected to one of the output phase voltages. This provided a very intense field between electrode rows with a somewhat weaker field extending outward from the sides of the array. Three output arrays were suspended along the **wingwall** in the center of the First Powerhouse and two arrays were suspended between piernoses in Unit 10, Slots B and C (Appendix Figures E-1 and E-2).

A portable electrode array, deployed by either a boom truck or the Corps of Engineers (COE) gantry crane, was also tested. This was designed to produce a large local field when used alone, or to increase the affected area when used with the other electrode arrays. The three electrode array types are shown in Figure E-Z.

Installation of the electrofishing gear was not completed until 17 July. Testing began immediately and continued at various times each day into August (Table E-1). Daily testing was usually conducted at dusk or dawn, when northern squawfish concentrations were highest. Catch data were recorded in number of fish per hour; however, this included the time needed to set up or move the electrode arrays and the time between shocks, while waiting for dispersed northern squawfish concentrations to return. Duration of the actual shock time was usually 2 to 3 minutes, unless juvenile or adult chinook salmon, *O. tshawytscha*, were stunned. Although the **piernose** electrode arrays could be moved to other locations, they were cumbersome, and the activity associated with moving them dispersed any northern squawfish in the area. The portable electrode array was less cumbersome, easily moved, and did not seem to frighten northern squawfish from the immediate area.

A steel net-frame with a 7.6-cm stretch-mesh fyke net was constructed to fit between piernoses and collect stunned fish swept into the ice-trash sluiceway. The frame was lowered and raised with a small crane. A **long-handled dipnet** was also used.

In addition, an electrofishing boat was used on one occasion to evaluate its usefulness in combination with a beach seine. This was done in the **tailrace** of the First Powerhouse. A 7.6-cm mesh trap-net lead or a **10.2-cm** mesh commercial salmon gill-net was used as a beach seine, anchored on shore and held in the current by a seine skiff. A U.S. Fish and Wildlife Service (USFWS) boat and crew electrofished from upstream to the net opening. The net was then brought to shore by the seine skiff. This method was tested at several points along the north shore of Bradford Island and along the Oregon shore near the navigation locks.

## Results and Discussion

The number of northern squawfish stunned and collected with the permanently installed electrofishing gear was low throughout the sampling period (17 July-20 August). Average catch was 8.9 fish per day or 5.1 fish per hour (Figure E-3), with 116 total northern squawfish stunned and captured.

On the first day of testing, an estimated 300-400 northern squawfish were stunned with the first electrofishing effort. However, the electrical current

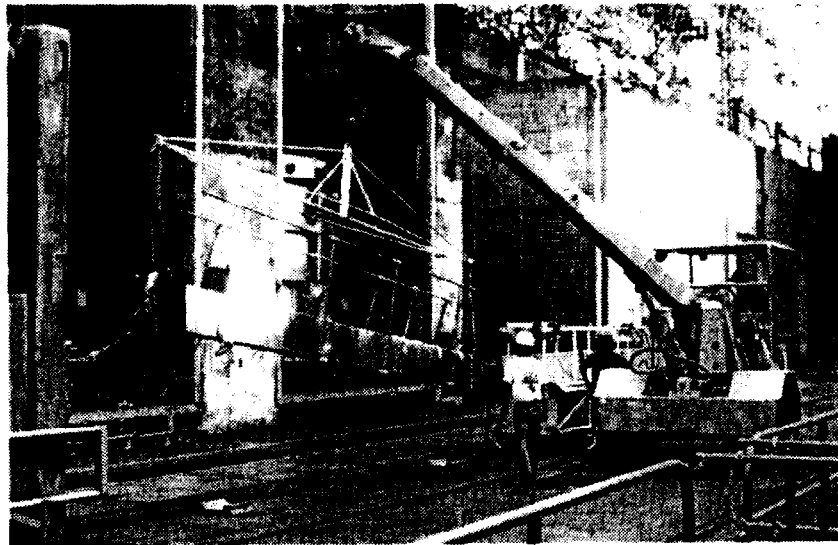
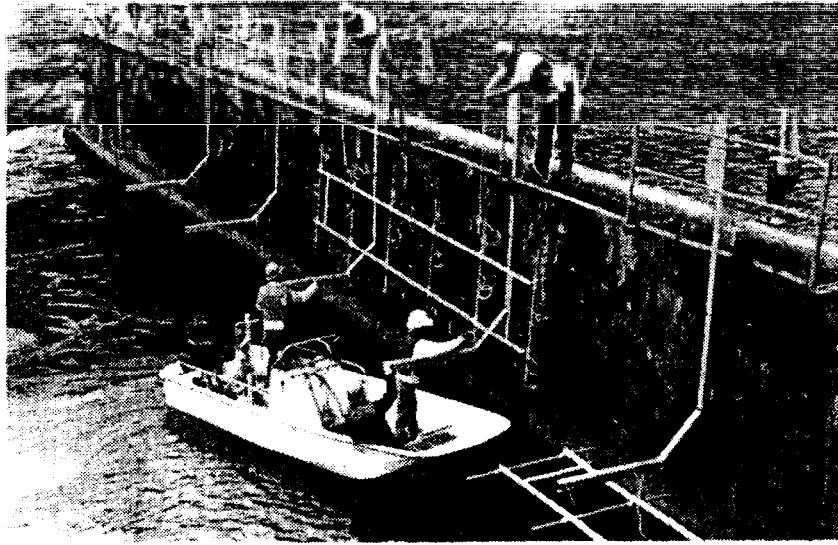
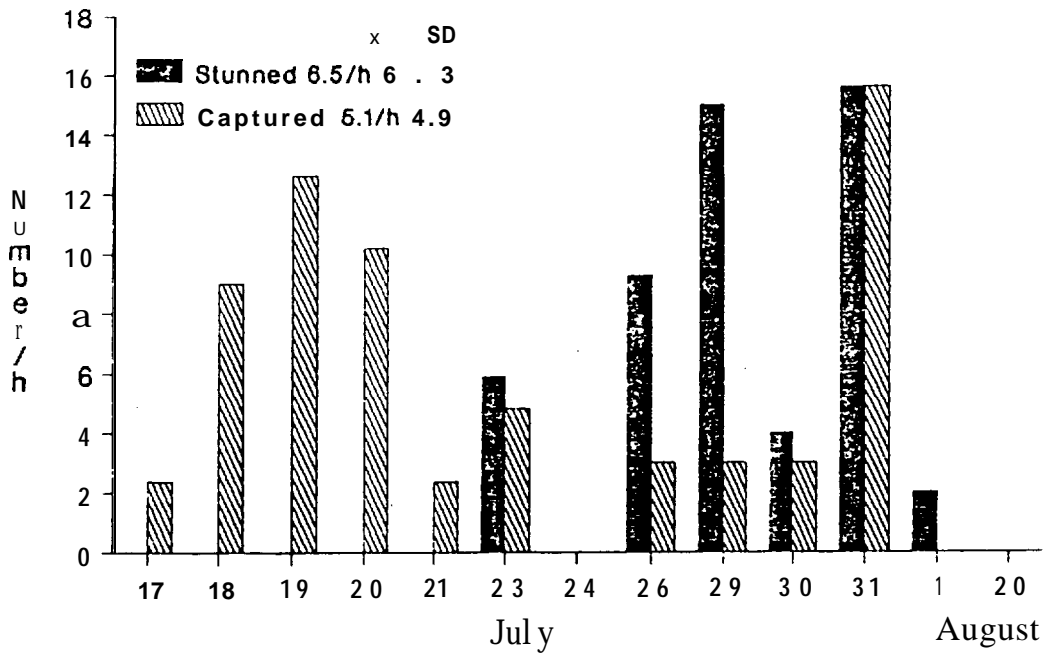

Figure E-2. Electrofishing gear tested for harvesting northern squawfish at Bonneville Dam First Powerhouse, summer 1991. Top, wingwall electrode array; middle, piernose electrode array; bottom, portable electrode array.

Table E-1. Sampling information for permanently installed electrofishing gear used at Bonneville Dam First Powerhouse, 1991.

Date	Time	Area	Gear
7/17	1445-1505 2041-2045	North of wingwall	Wingwall arrays
7/18	2131-2151	10B and 10C	Piernose arrays
7/19	1830-2115	10B and 10C	Piernose arrays
7/20	1900-2140	North of wingwall	Wingwall arrays
7/21	0620-0920	North of wingwall	Wingwall arrays
7/23	0616-0829	10B and 10C	Piernose arrays
7/24	0446-0514	10B and 10C	Piernose arrays
7/25	0547-0805	Most of powerhouse forebay	Portable array
7/29	2000-2152	1B, 3B-4B, 6A-9C	Portable array
7/30	2100-2215	1B, 1C, and 3A	Portable array
7/31	2030-2120	1C, 3A, 6B, and 6C	Portable array
8/01	2100-2200	10B and 10C	Piernose arrays
8/20	1830-1930	North of wingwall	Wingwall arrays

## Northern squawfish



## Subyearling chinook

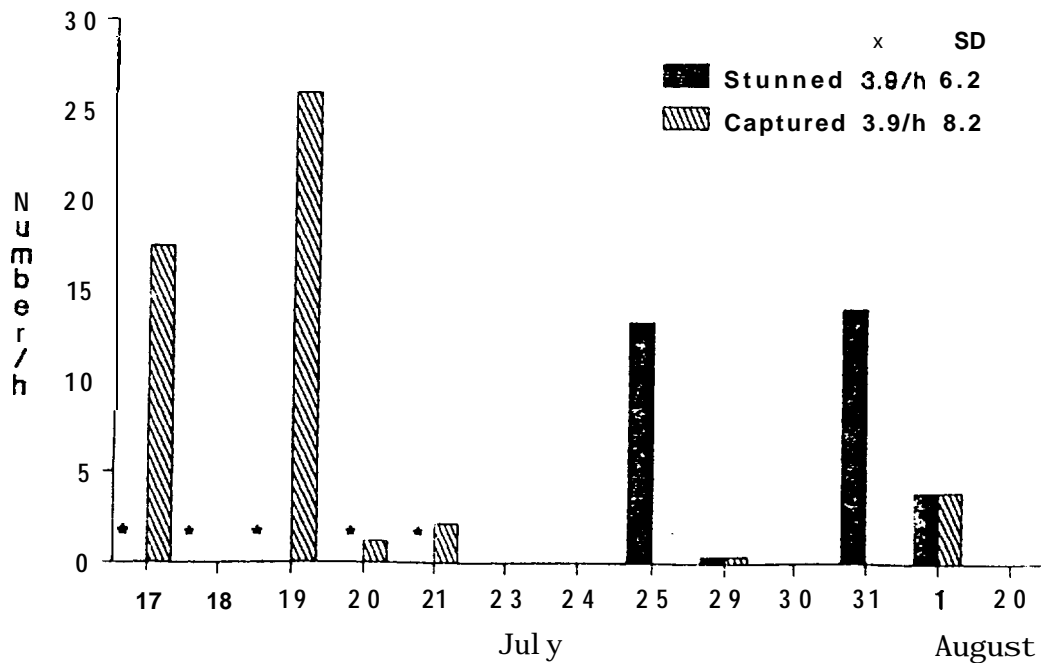

Figure E-3. The number of northern squawfish and subyearling chinook salmon stunned and captured per hour after electrofishing with permanently installed electrofishing gear at Bonneville Dam First Powerhouse forebay, 17 July to 20 August 1991. Asterisks denote dates where the numbers of stunned fish were not recorded. Means and standard deviations are for the number captured per hour.

was maintained for only 30 seconds. Later tests showed that 2 to 3 minutes were needed to stun northern squawfish effectively. Also, because of the limited hydraulic capacity of the ice-trash sluiceway, high **forebay** levels flooded the upper (north) end of the sluiceway. As a result, flow was not strong enough to pull stunned northern squawfish into the fyke net. Because they had not been sufficiently stunned, a majority of these fish recovered and swam away. In subsequent tests, the ice-trash sluiceway gates south of Unit 10 were readjusted to increase flow into the area where the fyke net was deployed. However, concentrations of northern squawfish similar to those on the first day of testing were not observed again.

The permanent electrofishing gear proved to be efficient in stunning adult American shad, *Alosa sapidissima*. Eight hundred and ninety-nine American shad were captured in the ice-trash sluiceway fyke-net during the first week of electrofishing. Because of the large number of adult American shad and the small number of northern squawfish stunned, capture methods were changed after the first week. The fyke-net frame was held above the surface with a crane and not set into a fishing position until a **sizeable** number of stunned northern squawfish were observed. This allowed time for American shad and juvenile salmonids to be swept into the ice-trash sluiceway, where they could get out of the electrical current quickly. An estimated 7,000 to 10,000 adult American shad were electrofished and passed into the ice-trash sluiceway during our efforts.

The numbers of subyearling chinook salmon that were stunned and recovered ranged from 0 to 72 per day (Figure E-3). Whenever they were observed, the power was shut off and they swam away. The number of smolts captured was usually low, averaging 6.9 per day. Two adult salmonids were observed during electrofishing, but swam away after the power was shut off. One disadvantage of using the fyke net was that subyearling chinook salmon that might have recovered were caught and died before they could be released. It appeared that most stunned fish--northern squawfish as well as adult and juvenile salmonids--recovered if not captured in the fyke net.

Beginning on 20 July, a portable electrode array deployed by a boom truck was tested. This increased mobility, but hindered the capture of stunned northern squawfish because it was difficult to alter the ice-trash sluiceway gate settings. A long-handled **dipnet** was used in some places to capture stunned fish; however, many northern squawfish escaped before they could be dipnetted. The portable electrode array was also deployed from the COE gantry crane on 25 July, with testing conducted from 0700 to 0800 h across the face of the First Powerhouse. This proved to be the easiest method for using the portable electrode array; however, few northern squawfish were observed or captured, perhaps due to the time of day.

The feasibility of using a seine net to capture northern squawfish stunned by an electrofishing boat was evaluated in the boat-restricted zone at Bonneville Dam on 18 June. Only 15 to 20 northern squawfish were captured, but few had been observed in the area and the work was done mainly to ascertain the practicality of using this type of gear around tailraces or other areas of high flow where northern squawfish congregate. Attempts were made at both hanging the net between two boats or anchoring one end to the beach (as a beach seine); the latter proved to be much more workable. Because of high flows in the tailrace, it was difficult to maintain the net in a

fishing position without having it become entangled around itself or around the boat (especially when two boats were used). The general consensus reached by participants was that the method could be used successfully in areas of low to moderate flow, using a net with larger-size mesh, larger corks, and a heavier headline.

Permanently installed electrofishing gear at Bonneville Dam was unsuccessful in removing northern squawfish. However, the late starting date for evaluating this equipment, high spill levels during the test period, and the possible success of concurrent predator removal programs (sport bounty and dam angling) may have affected test results. During 1989, large numbers of northern squawfish were observed along the north side of the wingwall at the First Powerhouse. During 1991, very few northern squawfish were observed along the wingwall--the area where our electrical arrays were concentrated. Uremovich et al. (1980) found an inverse relationship between spill and northern squawfish abundance in the forebay at Bonneville Dam First Powerhouse. During 1991, Bonneville Dam spill levels were much higher than in 1989 (Figure E-4), and this may have reduced the local northern squawfish population. Also, reducing First Powerhouse flows for purse seining may have changed northern squawfish distribution in the forebay, since flows were reduced during their peak abundance periods.

Alternatively, we may have conditioned northern squawfish to avoid areas directly adjacent to the dam near permanently installed electrofishing gear. After the first evening of electrofishing, large concentrations of northern squawfish were not observed again in areas close enough to electrofish. Unfortunately, the confounding effects of the other removal programs and powerhouse flow manipulations made this hypothesis difficult to test.

Uremovich et al. (1980) were unsuccessful at removing northern squawfish using an electrode array mounted on a collapsible box-net lowered between piers at Bonneville Dam. They attributed this lack of success to an inability to fish far enough away from the First Powerhouse to reach areas where northern squawfish congregate. With the wingwall and portable array, we were able to effectively electrofish 6 to 30 m away from the powerhouse. However, we were still unable to reach areas in the forebay with the largest concentrations of northern squawfish.

## CONTINUOUS MULTI-LURE **LONGLINE** GEAR

### Methods and Materials

A hand-cranked, continuous multi-lure longline was tested in the forebay of the First Powerhouse at Bonneville Dam. It stretched from the piernose in Slot 8C to the north side of the forebay--a distance of about 80 m (Figure E-1). A lure was attached every 2.7 m with a commercial snap-line swivel. The longline was then cranked to the opposite side of the forebay and northern squawfish and lures were removed as they came out of the water. When the last lure came out of the water, the operation was reversed. As many as 25 lures could be fished simultaneously using this method. A variety of lures were tested including plastic jigs (assorted colors and sizes), spinners, and

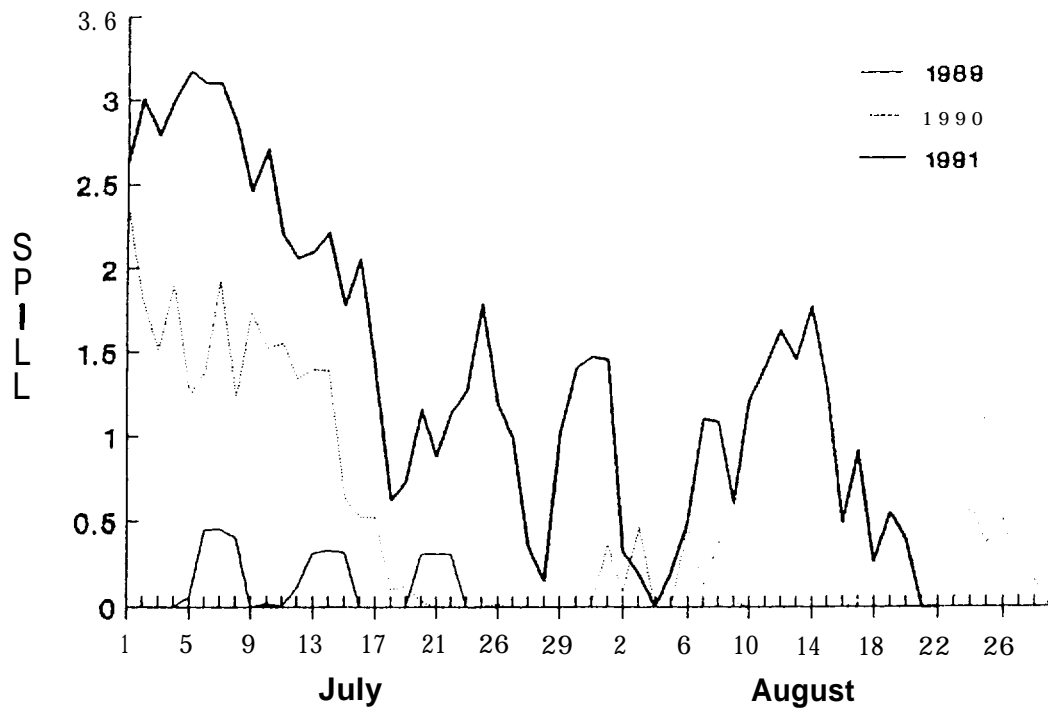

Figure E-4. Spill (m<sup>3</sup>/second in thousands) at Bonneville Dam, July-August **1989-1991.**



diving plugs. Both continuous cranking and letting the lures fish for various lengths of time were tested.

## Results and Discussion

Tests of continuous multi-lure longlining at Bonneville Dam First Powerhouse were conducted from 27 July to 28 August. Fifty-four northern squawfish were captured (Figure E-5). The catch averaged 2.9 northern squawfish per hour. One steelhead, O. mykiss, smolt was also captured. White plastic jigs were the most effective lure for squawfish. Generally, the first set of lures through the water caught the highest number of northern squawfish, then the fish appeared to become "hook shy" and the catch declined with subsequent passes. For this reason, most efforts were only 1 or 2 hours in duration. Letting the gear fish for longer periods before retrieving (up to 0.5 hour) did not increase catches.

Although this multi-lure longline gear did catch northern squawfish, it appeared less effective than traditional hook and line methods. A minimum of two people were required to operate this gear, and the catch per fisherman never exceeded that of dam anglers using a hook and line. Catch rates with hook and line were provided by dam anglers involved in the Columbia River Inter-Tribal Fish Commission removal program.<sup>3</sup> An advantage of fishing with hook and line was that fishermen could move to more productive areas when catch declined.

## PURSE SEINING

### Background

Purse seines have been used to capture northern squawfish on numerous occasions in the Columbia and Snake Rivers (Mathews et al. 1991). The majority of those seining efforts were relatively unsuccessful. However, in the tailraces of Little Goose and McNary Dams, purse seine catches of northern squawfish were occasionally large, at several hundred fish per set (Raymond et al. 1975; Sims et al. 1976; unpublished data, NMFS, Rufus, OR). These successful efforts provided the impetus for renewed attempts at improving catch efficiency and finding locations that would provide consistently large catches. Bonneville Dam First Powerhouse was selected for this research because of the large numbers of northern squawfish concentrated in the **forebay** near the surface during July and August. To seine safely in areas adjacent to the powerhouse, a partial turbine shut-down is required; therefore, purse seining had to be tested in both the **forebay** and **tailrace** simultaneously.

### Methods and Materials

#### Operating Conditions at Bonneville Dam First Powerhouse

Turbine Units 3 through 10 were shut down to create flow conditions suitable for seining while Turbine Units 1 and 2 remained in operation. To provide clearance for boats in the **forebay**, the large trashrack cleaning cable

---

<sup>3</sup> Blaine Parker, Columbia River Inter-Tribal Fish Commission. Pers. commun., July 1992.

# Northern squawfish

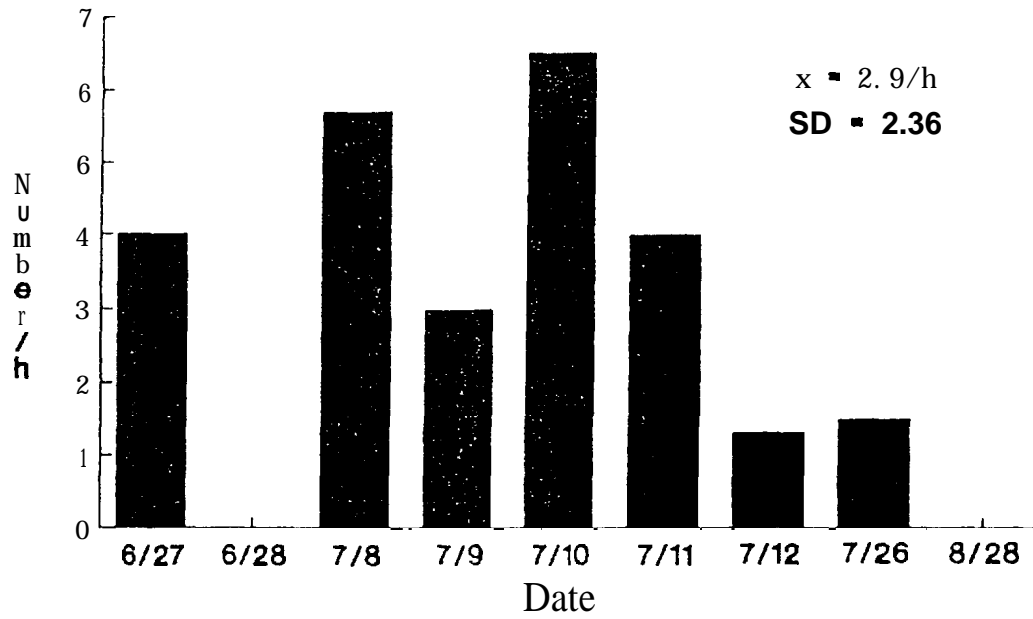

Figure E-5. the number of northern squawfish captured per hour with continuous multi-lure longline at Bonneville Dam forebay, summer **1991**.

was lowered to the bottom of the reservoir by the COE. This cable is used to deploy the trashrack rake and is usually suspended about 3 m above the water surface, extending from the end of the wing wall to the north shoreline. To further restrict flows in the tailrace, the following fish-ladder entrances were closed: orifice Gates 58, 62, and on two occasions Gate 34, plus sluice Gate 64 and weir Gate 65 (Figure E-6). These entrances are located between the middle and the north side of the powerhouse (Turbine Units 1 and 2 are on the south side of the dam). In addition, monofilament lines were removed to allow boat access. These are normally suspended across the tailrace to exclude **predaceous** birds from the outfall areas of the juvenile **salmonid** bypass and turbine boils.

#### Dates and Times of Seining

Dates and times for purse seining were chosen to minimize impacts on returning adult salmonids while fully utilizing times when northern squawfish would be concentrated near the dam. Delays in adult **salmonid** passage were expected as a result of the 80% shutdown of the powerhouse. The week of 22-29 July was chosen for seining because of the expected low number of adult salmonids (Appendix Table E-2). Evening hours (1900-2230 h) were selected because passage of adult salmonids over the dam generally peaks at midday and declines shortly thereafter (Appendix Table E-3). Evening hours are also the peak of northern squawfish activity.

#### Purse Seines

A special purse seine with adjustable depth and length was designed for use in moderate current and at multiple locations in the Columbia and Snake Rivers. The seine was constructed to allow alteration of the length (from 91 to 183 m) and depth (from 5 to 15 m, in 1.5-m increments). The bunt section of webbing was 14 m long with 5.1-cm stretch mesh. Other webbing, except for the **leadline** panel, was 6.4-cm stretch mesh. Nylon twine of 1.2-mm diameter (#12) was used for all webbing. The **corkline** web panel was 3 m deep with a zipper along the bottom. The middle three webbing panels were 3, 1.5, and 6 m deep, each having zippers on both edges for inclusion or exclusion from the seine, depending on depth requirements. The **leadline** panel was 1.5 m deep and constructed of heavier 3-mm polyethylene web. It had 8.9-cm stretch-mesh openings with a zipper at the top of the panel. The **leadline** was hung 10% shorter than the **corkline** to provide a forward curl when under tow. Purse lines were 1.6-cm diameter solid-core braided nylon. Each end of the seine net was tapered, using breast lines one-half the length of the hanging web. For additional construction details refer to Appendix Figure E-3. This seine net was used in the **forebay** with the middle (1.5-m) section of webbing excluded, for overall dimensions of 183 m long by 13.5 m deep.

The initial research design called for NMFS to seine the **forebay** while UW researchers concurrently seined the tailrace. UW researchers proposed to also fish in the tailrace, using a purse seine net specially designed to catch northern squawfish (Mathews et al. 1991). However, due to unanticipated delays, UW personnel and equipment were not available. On short notice, NMFS adapted purse seine nets and vessels normally used to sample juvenile salmonids (Ledgerwood et al. 1990) to fish in the tailrace. On the first night, a seine measuring 229 m long by 9.8 m deep, constructed with 1.9-cm stretch-mesh webbing was used. This net proved too deep for the **tailrace**

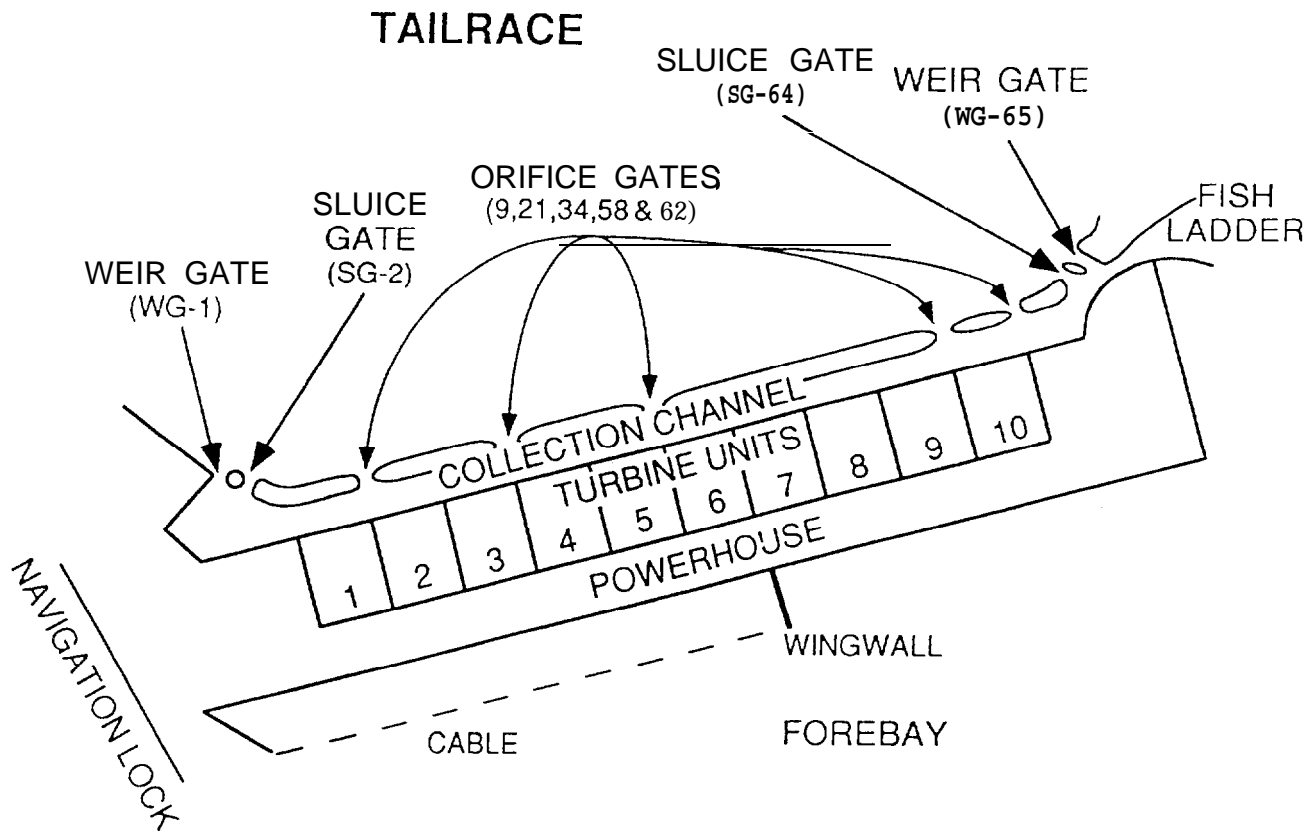

Figure E-6. Location of adult fish attraction/collection system, forebay wingwall, and trashrack cleaning cable at Bonneville Dam First Powerhouse.

(minimum depths about 7.5 m). On the second night, a smaller seine was used. This measured 137 m long by 5.2 m deep, and was constructed with 1.9-cm stretch-mesh webbing. The shorter net was better suited to the confined area of the tailrace, away from the discharge current of Turbine Units 1 and 2.

### Fishing Procedures and Fish Processing

Purse seines were set off the seiner with the assistance of a seine skiff. The nets were set in two configurations, opening toward and away from the dam. Generally, sets were made as near as possible to the powerhouse. After a net was deployed (requiring about 3 minutes) it was immediately closed by returning the skiff end of the net to the seiner (Figure E-7). Hydraulic capstans were used to purse the bottom of the net closed (requiring from 15 to 30 minutes). The vessel fishing the special northern squawfish seine was equipped with an overhead power block to retrieve webbing from the water. The block required about 15 minutes to retrieve webbing. The webbing of the juvenile salmonid net was pulled in by hand, requiring about 10 minutes. The retrieval action crowded captured fish toward the bunt. Non-target fish were counted and released without processing, and, if possible, were released from the net prior to complete retrieval of gear. Numbers of American shad were estimated. Captured northern squawfish were counted, measured, marked, and released for indexing.<sup>4</sup> Northern squawfish in excess of marking requirements were killed.

### Results

The purse seine harvest of northern squawfish was low; only 134 were captured in 17 purse seine sets made from 23 to 28 July (Table E-2). Eight sets were made in the tailrace using the 137-m juvenile salmonid seines and 52 northern squawfish were caught. Neither set configuration was superior. Six sets were made in the forebay, using the 183-m northern squawfish seine and catching a total of 79 northern squawfish. In addition, on 27 and 28 July, three sets were made in the forebay using the 137-m seine and three northern squawfish were caught. All sets in the forebay were made with the net opening away from the dam to allow seiners to be towed clear from possible entanglement with debris.

Incidental catches of American shad were substantial, and estimates occasionally approached 5,000 fish per set. When large numbers of American shad were captured, most were allowed to escape over the corkline; possibly some target fish escaped as well. Four adult and 92 juvenile salmonids<sup>6</sup> were captured--these fish were generally released prior to complete retrieval of the net. Complete catch results are presented in Appendix Table E-4. Poor catches of northern squawfish and concerns about possible disruption of upstream passage of adult salmonids prompted termination of seining. The termination after 28 July concluded seine testing one day earlier than originally proposed.

---

<sup>4</sup> Marking of northern squawfish performed by ODFW personnel, David Ward, project leader.

<sup>5</sup> The 229-m juvenile salmonid seine was fished on 22 July (one set), but the set was aborted due to entanglement with the river bottom.

<sup>6</sup> No juvenile salmonids were captured in the larger-mesh 183 m long squawfish seine.

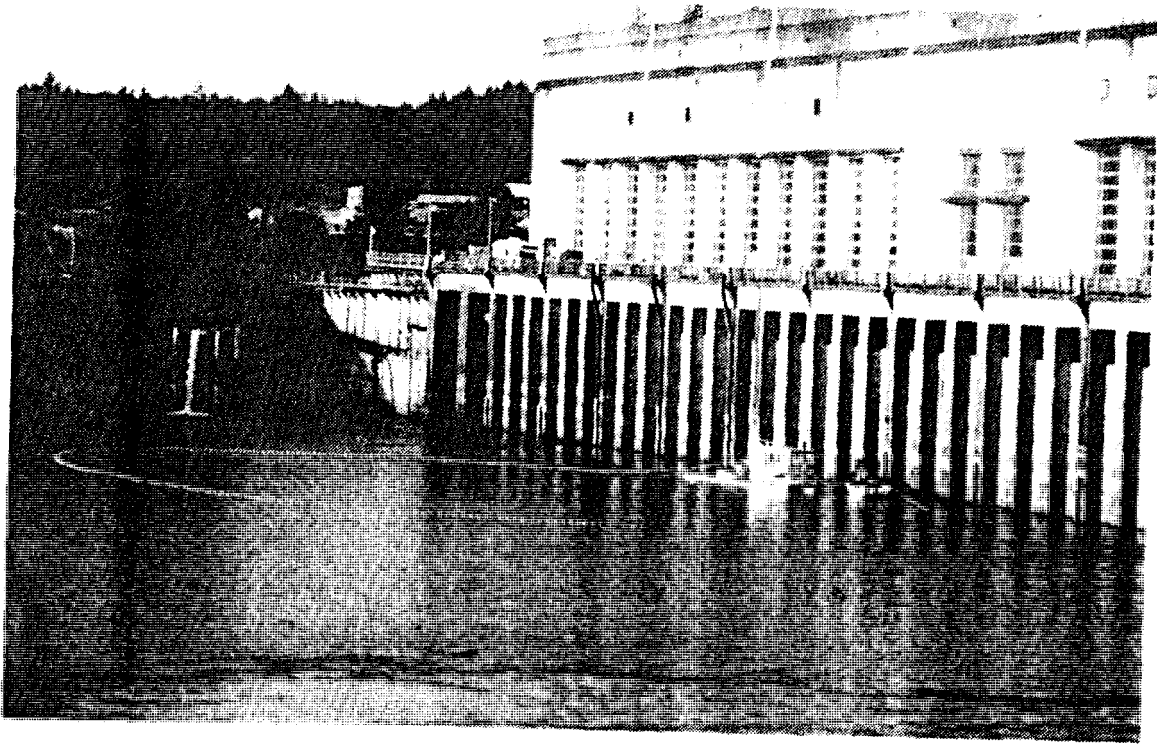

Figure E-7. Purse seine boat in tailrace of Bonneville Dam First Powerhouse.

Table E-Z. Purse seine catches of northern squawfish at Bonneville Dam First Powerhouse, 1991.

Date (July)	Time of set	Set configuration <sup>a</sup>	Seine dimensions	Northern squawfish
<u>Tailrace</u>				
22	2041	Away, 3 m	229 m x 9.8 m	-- <sup>b</sup>
23	1918	Away, 3 m	137 m x 5 m	0
23	1953	Toward, 3 m	137 m x 5 m	12
24	1906	Toward, 3 m	137 m x 5 m	-- <sup>c</sup>
24	2010	Toward, 3 m	137 m x 5 m	3
25	1908	Toward, 3 m	137 m x 5 m	21
25	1951	Toward, 3 m	137 m x 5 m	6
25	2020	Toward, 3 m	137 m x 5 m	3 <sup>d</sup>
26	2000	Away, 3 m	137 m x 5 m	1
26	2040	Toward, 3 m	137 m x 5 m	6
TOTAL				52
<u>Forebay</u>				
22	1900	Away, 3 m	183 m x 13.5 m	-- <sup>b</sup>
23	1900	Away, 3 m	183 m x 13.5 m	20
24	1900	Away, 3 m	183 m x 13.5 m	15
25	1900	Away, 150 m	183 m x 13.5 m	25
26	2000	Away, 3 m	183 m x 13.5 m	8
27	2103	--	137 m x 5 m	-- <sup>c</sup>
27	2200	Away, 3 m	137 m x 5 m	1
27	2110	Away, 3 m	183 m x 13.5 m	3
28	2108	Away, 3 m	137 m x 5 m	1
28	2142	Away, 40 m	137 m x 5 m	1 <sup>d</sup>
28	2100	Away, 3 m	183 m x 13.5 m	8
TOTAL				82

<sup>a</sup> Purse seine set configuration code: 'away' = net opening away from the face of the dam; 'toward' = net opening toward the dam; and the approximate distance the net was deployed from the dam (m).

<sup>b</sup> Submerged debris entangled the net and compromised set.

<sup>c</sup> Difficulties with fishing gear compromised set.

<sup>d</sup> Currents created by operation of Turbine Units 1 and 2 pulled corkline under surface allowing some fish to escape.

## Discussion

Several factors may have reduced purse seine catches of northern squawfish. These fish may have sounded or left the areas adjacent to turbines that were shut down. They may have avoided the area because of boat engine noise. The largest single catch of northern squawfish (25 fish) occurred in a set about 150 m upstream from the dam, where the seine was in contact with the bottom during pursing. Modification of purse seining equipment to rapidly close the bottom of the net may improve catch results if fish are escaping by sounding.

Although large numbers of northern squawfish were observed in the forebay during late July 1989, other removal efforts underway in 1991 may have altered population distribution in the immediate vicinity of the First Powerhouse. However, preliminary catch data<sup>7</sup> from angling efforts in the vicinity of Bonneville Dam during summer 1991 do not suggest a significant decrease in numbers of northern squawfish during the week of purse seining (Figure E-8).

Of paramount concern during this study were possible impacts on upstream passage of adult salmonids due to reduced river flows through the tailrace. This was a result of the partial shutdown of the First Powerhouse, which was necessary for seining. On a daily basis, we examined the counts of adult salmonids obtained from the Washington shore and Bradford Island counting stations (Table E-3). Although there were large daily variations, no apparent impacts on migration could be detected.

## CONCLUSIONS: ALL TECHNIQUES

None of the northern squawfish removal techniques evaluated at Bonneville Dam during 1991 proved effective; however, the late starting date, other northern squawfish removal programs in progress, and the high rate of water spill may have influenced results. Electrofishing with both permanently installed and portable electrode arrays may still prove effective if northern squawfish congregate near the First Powerhouse as they have in past years. Continuous multi-lure longlining is too labor-intensive and ineffective to warrant further testing.

Purse seine catches of northern squawfish were also considerably lower than expected, based on numbers of northern squawfish observed in the surface waters around the dam. Altered powerhouse operating conditions required for seining may have caused the poor catch, since northern squawfish may have left the immediate area after turbines were shut down. It is also possible that northern squawfish eluded the net by sounding before the seine could be pursed.

Incidental catches of adult salmonids by purse seine were low (four), and except for American shad, other incidental catches were low. Reduction in passage of adult salmonids during the seining period was not discernible.

---

<sup>7</sup> Kathy McRae, Columbia River Inter-Tribal Fish Commission. Pers. commun., November 1991.



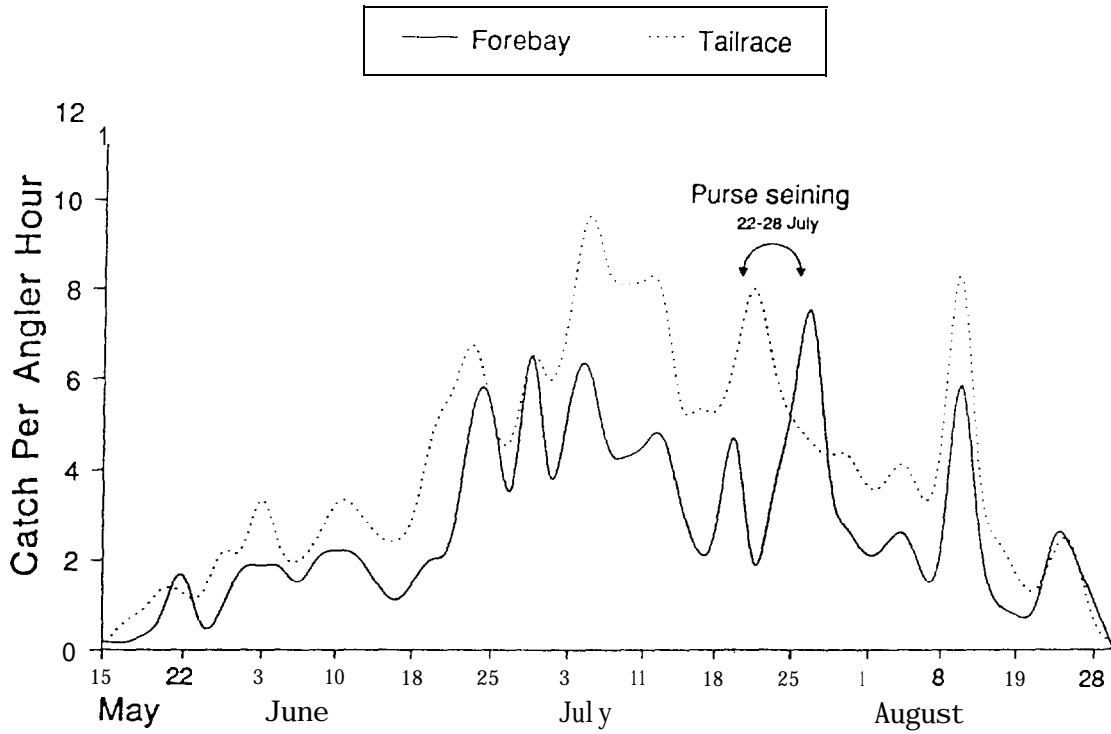

Figure E-8. Weekly catch of northern squawfish by angling in vicinity of Bonneville Dam First Powerhouse<sup>6</sup>, comparing temporal catch distribution to period of purse seine effort.

Table E-3. Combined adult salmon counts for Bradford Island and Washington shore monitoring stations at Bonneville Dam during periods just prior to and during squawfish seining at the First Powerhouse.

		Time															
		0500 to 0550	0600 to 0650	0700 to 0750	0800 to 0850	0900 to 0950	1000 to 1050	1100 to 1150	1200 to 1250	1300 to 1350	1400 to 1450	1500 to 1550	1600 to 1650	1700 to 1750	1800 to 1850	1900 to 1950	2000 to 2050
		Number of adults passing <sup>a</sup>															
20	July																
	Bradford	35	22	21	32	48	25	<b>31</b>	44	33	35	34	49	42	77	34	26
	Washington	199	315	125	106	125	112	123	156	70	92	98	159	142	126	45	21
21	July																
	Bradford	27	23	23	38	31	22	21	41	25	50	59	63	84	64	47	18
	Washington	44	<b>177</b>	101	142	189	160	227	165	98	148	166	143	138	123	69	26
22	July <sup>b</sup>																
	Bradford	29	36	16	27	39	18	43	31	24	41	36	63	54	32	39	33
	Washington	125	188	78	158	150	79	85	38	116	105	56	94	120	126	68	118
23	July																
	Bradford	15	30	15	35	39	<b>13</b>	48	46	36	67	68	31	50	49	49	30
	Washington	161	254	94	57	91	85	144	160	105	101	92	113	122	63	42	24
24	July <sup>b</sup>																
	Bradford	31	31	12	21	25	37	39	59	69	a7	93	102	111	120	51	22
	Washington	198	139	100	65	84	136	125	144	110	120	256	235	168	125	81	15
25	July <sup>b</sup>																
	Bradford	10	11	15	6	19	36	28	24	<b>31</b>	28	67	80	69	74	52	19
	Washington	163	290	117	66	176	121	166	198	176	132	257	172	150	71	36	14
26	July <sup>c</sup>																
	Bradford	d	28	27	25	19	28	13	27	30	62	32	45	69	55	25	18
	Washington	129	341	102	59	63	108	136	101	157	165	127	125	78	77	36	25
27	July <sup>d</sup>																
	Bradford	6	<b>13</b>	8	5	9	10	21	34	45	36	52	55	112	88	56	38
	Washington	195	107	101	123	186	139	143	209	134	107	122	128	73	88	65	46
28	July <sup>e</sup>																
	Bradford	11	23	34	48	23	38	54	19	48	50	92	81	81	163	86	57
	Washington	134	64	15	73	40	78	85	83	122	112	102	90	97	70	50	21
29	July																
	Bradford	33	59	49	57	93	50	57	64	69	51	51	71	86	84	50	32
	Washington	58	45	40	97	142	115	193	197	227	295	235	258	159	193	82	37
30	July																
	Bradford	19	25	9	22	27	32	58	70	46	49	65	63	76	107	54	<b>31</b>
	Washington	92	<b>124</b>	93	143	197	228	278	223	230	174	188	212	130	203	124	69

<sup>a</sup> Combined counts include adult chinook salmon and jacks, sockeye salmon, and steelhead.

<sup>b</sup> Shut-down of First Powerhouse Turbine Units 3-10 from 1900 to 2100 h.

<sup>c</sup> Shut-down of First Powerhouse Turbine Units 3-10 from 2000 to 2100 h.

<sup>d</sup> Shut-down of First Powerhouse Turbine Units 3-10 from 2100 to 2230 h.

<sup>e</sup> Shut-down of First Powerhouse Turbine Units 3-10 from 2100 to 2200 h.

Because of the small numbers of northern squawfish captured using all techniques tested, no analysis of catch per unit effort (CPUE) versus cost was done.



## REFERENCES

- Beamesderfer, R. C., and B. E. Rieman. 1991. Abundance and distribution of northern squawfish, walleyes, and smallmouth bass in John Day Reservoir, Columbia River. *Transactions of the American Fisheries Society* 120:439-447.
- Ledgerwood, R. D., E. M. Dawley, L. G. Gilbreath, P. J. Bentley, B. P. Sandford, and M. H. Schiewe. 1990. Relative survival of subyearling chinook salmon which have passed Bonneville Dam via the spillway or the Second Powerhouse turbines or bypass system in 1989, with comparisons to 1987 and 1988. Report to United States Army Corps of Engineers, Contract E85890024/E86890097, 64 p. plus Appendixes. (Available from Northwest Fisheries Science Center, 2725 Montlake Blvd. E., Seattle, WA 98112-2097).
- Mathews, S. B., T. Iverson, R. W. Tyler, and G. Ruggerone. 1991. Evaluation of harvesting technology for potential northern squawfish commercial fisheries in Columbia River reservoirs. Report C in A. A. Nigro, editor, *Developing a Predation Index and Evaluating Ways to Reduce Salmonid Losses to Predation in the Columbia River Basin*. Oregon Department of Fish and Wildlife, Contract Number DE-A179-88BP92122. Final Report to Bonneville Power Administration, Portland, OR.
- Poe, T. P., H. C. Hansel, S. Vigg, D. E. Palmer, and L. A. Prendergast. 1991. Feeding of predaceous fishes on out-migrating juvenile salmonids in John Day Reservoir, Columbia River. *Transactions of the American Fisheries Society* 120:405-420.
- Raymond, H. L., C. W. Sims, R. C. Johnsen, and W. W. Bentley. 1975. Effects of power peaking operations on juvenile salmon and steelhead trout. Report to United States Army Corps of Engineers, Contract DACW57-74-F-6021, 46 p. plus Appendixes. (Available from Northwest Fisheries Science Center, 2725 Montlake Blvd. E., Seattle, WA 98112-2097.)
- Rieman, B. E., R. C. Beamesderfer, S. Vigg, and T. P. Poe. 1991. Estimated loss of juvenile salmonids to predation by northern squawfish, walleyes, and smallmouth bass in John Day Reservoir, Columbia River. *Transactions of the American Fisheries Society* 120:448-458.
- Sims, C. W., R. C. Johnson, and W. W. Bentley. 1976. Effects of power peaking operations on juvenile salmon and steelhead trout migrations, 1975. Report to United States Army Corps of Engineers, Contract Number DACW68-76-C-0025, 36 p. (Available from Northwest Fisheries Science Center, 2725 Montlake Blvd. E., Seattle, WA 98112-2097.)
- Uremovich, B. L., S. P. Cramer, C. F. Willis, and C. O. Junge. 1980. Passage of juvenile salmonids through the ice and trash sluiceway and squawfish predation at Bonneville Dam, 1980. Report to U. S. Army Corps of Engineers, Contract DACW57-78-C-0058. (Available from Oregon Department of Fish and Wildlife, Portland, OR.)

Vigg, S., T. P. Poe, L. A. Prendergast, and H. C. Hansel. 1991. Rates of consumption of juvenile salmonids and alternative prey fish by northern squawfish, walleyes, smallmouth bass, and channel catfish in John Day Reservoir, Columbia River. Transactions of the American Fisheries Society 120:421-438.



## APPENDIX FIGURES

Appendix Figure E-1. View of three **wingwall** arrays used for electrofishing northern squawfish at Bonneville Dam First Powerhouse.

Appendix Figure E-Z. Cross-section of **piernose** array used for electrofishing northern squawfish at Bonneville Dam First Powerhouse.

Appendix Figure E-3. Northern squawfish purse seine designed for use around hydroelectric dams on the Snake and Columbia Rivers.



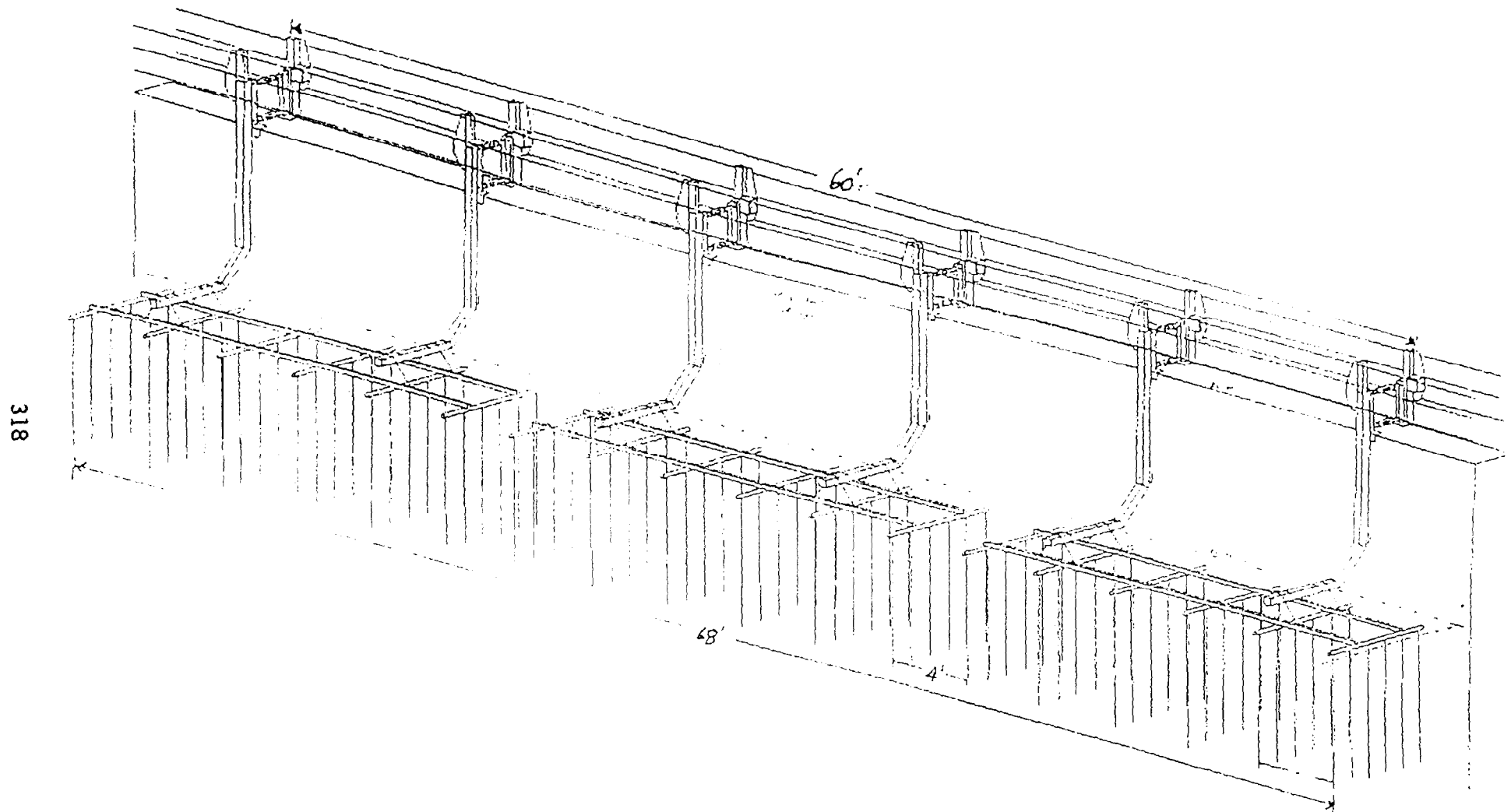

Appendix Figure E-1. View of three wingwall arrays used for electrofishing northern squawfish at Bonneville Dam First Powerhouse.

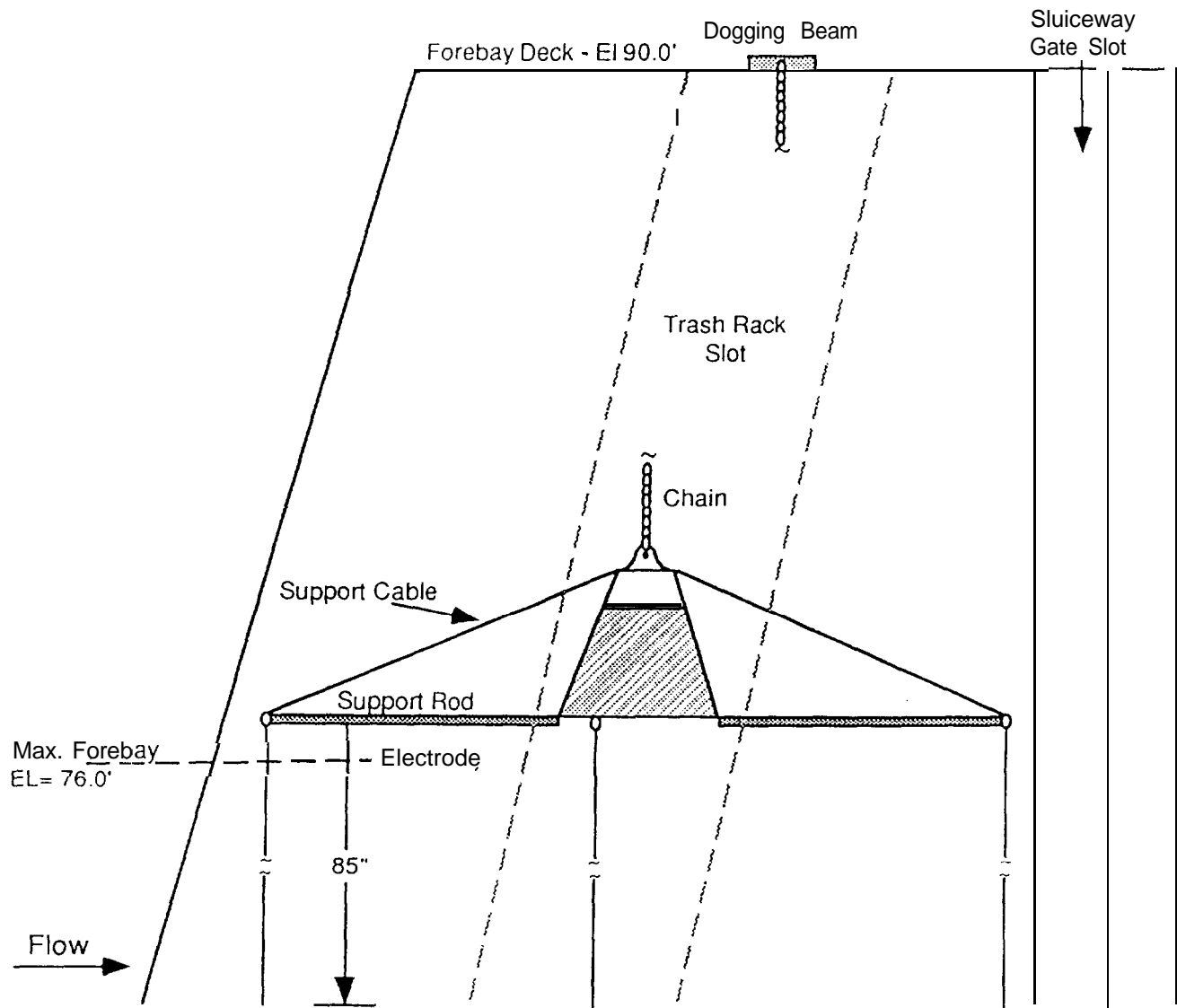

Appendix Figure E-Z. Cross-section of piernose array used for electrofishing northern squawfish at Bonneville Dam First Powerhouse.

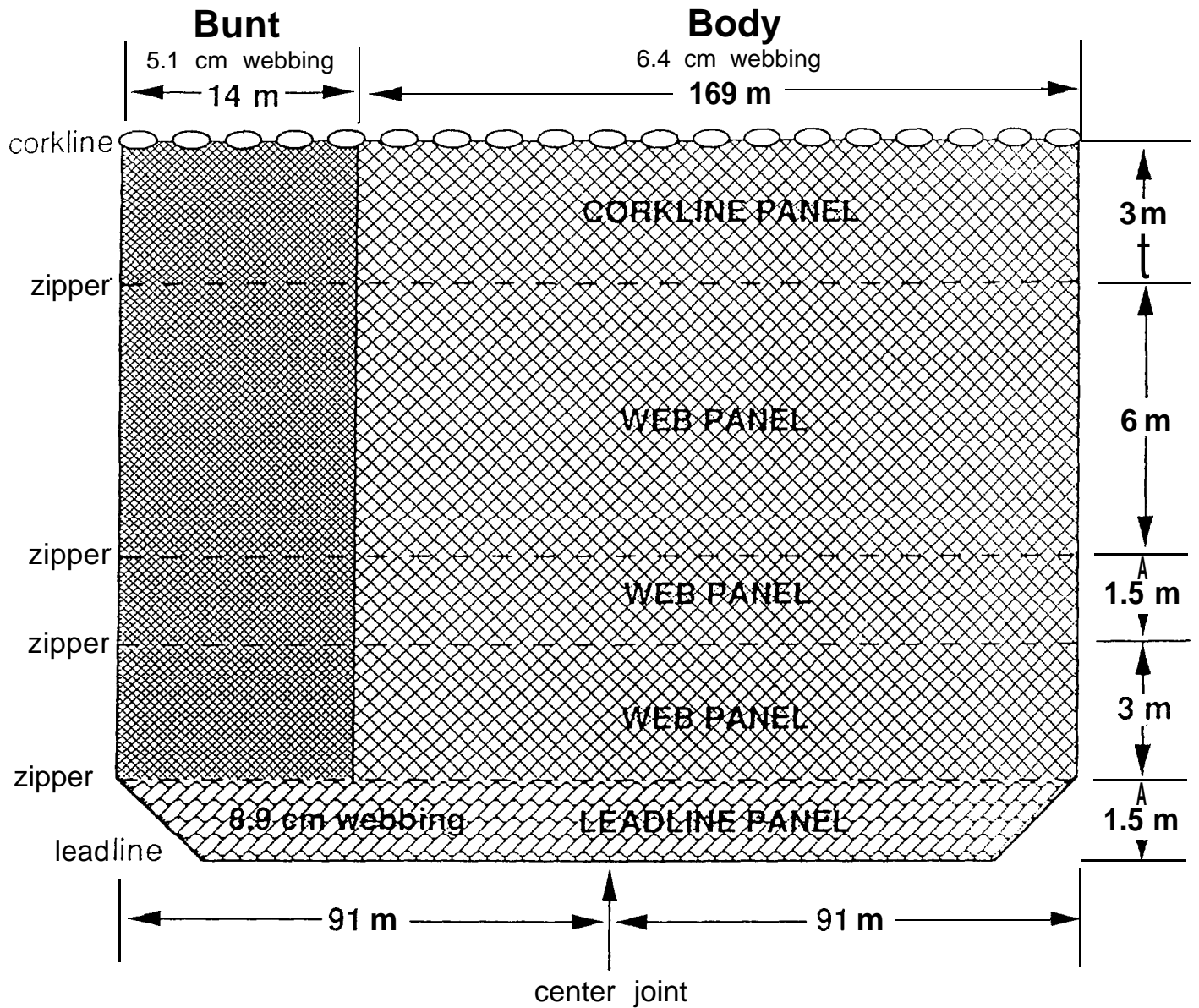

Appendix Figure E-3. Northern squawfish purse seine designed for use around hydroelectric dams on the Snake and Columbia Rivers.

## APPENDIX TABLES

Appendix Table E-1. Specifications of electrofishing equipment used at Bonneville Dam First Powerhouse, 1991.

Appendix Table E-2. Daily counts of adult salmonids passing Bradford Island monitoring station at Bonneville Dam, 1990.

Appendix Table E-3. Counts of adult salmonids observed at the upstream entrance gates of the First Powerhouse and at the Bradford Island counting station at Bonneville Dam, 14-25 August 1983.

Appendix Table E-4. Catch composition and set descriptions of the purse seine effort at Bonneville Dam First Powerhouse, 1991.

Appendix Table E-1. Specifications of electrofishing equipment used at Bonneville Dam First Powerhouse, 1991.

Alternator:

kVA: 75  
kW: 60  
Output current: 90 A per phase at 480 V.  
RPM: 1800  
Frequency: 60 Hz  
Phase: 3, Wye connected without neutral  
Power Factor: 0.8  
Voltage: 480, 240, 208

Control:

output: Full-cycle three-phase alternating current.  
Switching: 600,000 operations at full rated current.  
Metering: Individual phase currents and phase A-B Voltage. 0 to 500 VAC A.  
Safety: Key operated audio alarm, front panel status indicator, remote operator switch, safety grounding system.  
Power distribution: High voltage and current twist lock connectors.

Arrays:

**Wingwall arrays:** Made up of three sections covering 21 m total length. Each section is electrically divided into two groups of three rows; each row is energized with a different phase voltage. Rows consist of six electrodes, constructed of 216 cm long, 5-mm stainless steel cables. Electrodes are spaced at 25-cm intervals on each row; rows are spaced on 1.2-m centers. This arrangement will produce a strong electrical field between rows for the length of the array.

**Piernose arrays:** Consist of three rows of electrodes with each row connected to a different phase voltage. Electrodes in a row are spaced on 61-cm centers and rows are spaced 1.4 m apart.

**Portable array:** Consists of three Smith-Root UAA-6 arrays. One connected to each phase voltage.

Appendix Table E-2. Daily counts of adult salmonids passing Bradford Island monitoring station at Bonneville Dam, 1990.

Date	Chi nook	<u>Adult counts<sup>a</sup></u>	
		Sockeye	Steel head
15 July	23	85	127
16	<b>25</b>	46	133
17	<b>26</b>	35	122
18	27	73	213
19	37	47	233
20	24	<b>31</b>	176
21	14	<b>31</b>	124
22	52	65	350
23	39	27	292
24	11	19	111
25	7	<b>9</b>	190
26	10	<b>2</b>	126
27	10	4	171
28	11	13	141
29	8	7	212
30	90	10	646
31	59	7	254
01 August	38	3	355
02	8	4	119
03	30	2	443
04	56	0	570
<b>05</b>	91	<b>0</b>	475
<b>06</b>	21	<b>0</b>	381
07	21	0	381
08	52	0	620
09	30	0	373
10	35	0	384

<sup>a</sup> Numbers are partial daily counts. Hourly counts taken from 0600 to 1200 h.

Appendix Table E-3. Counts of adult salmonids observed at the upstream entrance gates of the First Powerhouse and at the Bradford Island counting station at Bonneville Dam, 14-25 August 1983.<sup>ab</sup>

Time	Average counts at entrance gates					Weir #1	Percent of daily entries	
	Weir #65	Sluice #64	Orifice <sup>c</sup> #62	Orifice #58	Sluice #2		Entrance counts <sup>d</sup>	Ladder counts <sup>e</sup>
0600	-- <sup>f</sup>	--	--	--	--	--	--	1.2
0700	23.4	13.2	12.3	5.8	43.2	15.0	6.5	5.3
0800	30.6	31.8	14.0	8.4	58.2	24.6	9.3	3.2
0900	59.4	49.8	18.8	6.8	72.0	15.0	11.5	4.5
1000	46.2	60.0	22.9	9.0	67.8	18.0	11.8	6.4
1100	42.6	33.6	23.1	11.2	75.0	13.8	11.3	5.6
1200	36.0	29.4	24.7	6.7	65.4	24.0	10.7	7.7
1300	46.2	28.8	14.1	5.0	47.4	19.2	8.6	8.3
1400	23.4	28.2	13.8	6.7	55.8	13.8	8.2	8.9
1500	33.6	22.2	18.3	4.3	49.8	13.2	8.1	8.3
1600	32.4	30.0	13.7	3.6	48.6	15.6	8.3	7.2
1700	43.2	23.4	10.3	4.0	47.4	13.8	7.9	7.2
1800	32.4	19.8	11.3	4.6	30.0	10.8	6.0	8.9
1900			--			--	--	7.7
2000	--	--	--			--	--	6.7
2100	--		--				--	2.9

<sup>a</sup> Data courtesy Jim Kuski, Robert Stansell, and Bill Naga; Corps of Engineers, Bonneville Dam. Downstream passage excluded in these data.

<sup>b</sup> The only year these data were recorded was 1983. Data set for 14-25 August most closely corresponded to expected time period of proposed research.

<sup>c</sup> Orifice gates 34, 21, and 9 not represented.

<sup>d</sup> Entrance counts from the First Powerhouse fishways.

<sup>e</sup> Ladder counts from Bradford Island counting station.

<sup>f</sup> (--) denotes that entrance information is not available.

Appendix Table E-4. Catch composition and set descriptions of the purse seine effort at Bonneville Dam First Powerhouse, 1991.

Date	Water temp °C	Time of set	Time of outage	Seine dimensions	Fishing location	Set configuration	Northern squaui sh	Adult sal moni ds	Juvenile salmoni ds	Ameri can shad	Red-si ded shi ner	Peamouth
July 22	20	2041	1900	229 m x 9.8 m	tailrace	Away, 3 m	-- <sup>a</sup>	--	--		--	
"		1900	"	183 m x 13.5 m	forebay	Away, 3 m	—	--	--	--	--	
23	20	1918	1900	137 m x 5 m	tailrace	Away, 3 m	0	0	0	0	0	0
"		1953	"	137 m x 5 m	tailrace	Toward, 3 m	12	0	1	14	0	1
"		1900	"	183 m x 13.5 m	forebay	Away, 3 m	20	0	0	2	0	0
24	20	1906	1900	137 m x 5 m	tailrace	Toward, 3 m	—	--	--	—	--	--
"		2010	"	137 m x 5 m	tailrace	Toward, 3 m	3	0	0	0	0	2
"		1900	"	1a3 m x 13.5 m	forebay	Away, 3 m	15	0	0	155	0	0
25	20	1908	1900	137 m x 5 m	tailrace	Toward, 3 m	21	0	0	0	20	15
"		1951	"	137 m x 5 m	tailrace	Toward, 3 m	6	0	0	2	0	0
"		2020	"	137 m x 5 m	tailrace	Toward, 3 m	3	2	0	6	0	0
"		1900	"	1a3 m x 13.5 m	forebay	Away, 150 m	25	0	0	-4,000	0	0
26	20	2000	2000	137 m x 5 m	tailrace	Away, 3 m	1	0	3	1	0	0
"		2040	"	137 m x 5 m	tailrace	Away, 3 m	6	0	1	0	0	0
"		2000	"	183 m x 13.5 m	forebay	Away, 3 m	a	1	0	-5,000	0	0
27	20	2103	2100	137 m x 5 m	forebay	--	--	--	--	--	--	--
"		2200	"	137 m x 5 m	forebay	Away, 3 m	1	0	22	234	0	0
"		2110	"	1a3 m x 13.5 m	forebay	Away, 3 m	3	0	0	10	0	0
28	20	2108	2100	137 m x 5 m	forebay	Away, 3 m	1	0	55	25	0	0
"		2142	"	137 m x 5 m	forebay	Away, 40 m	1	0	10	10	0	0
"		2100	"	183 m x 13.5 m	forebay	Away, 3 m	2	1	0	-5,000	0	0

<sup>a</sup> "--" denotes data not available. Set compromised because of difficulties with gear.





REPORT F

NORTHERN SQUAWFISH REWARD PROGRAM

**1991** ANNUAL REPORT

Prepared by

Pam Kahut, **Liza** Bauman, and Al Didier  
Pacific States Marine Fisheries Commission

During **1991**, the Voucher Payment project of the Squawfish Control Program paid a total of \$470,501 to anglers in the sport-reward and tribal longline fisheries for 156,322 squawfish that were documented on 12,320 vouchers.

#### Sport Reward Fishery

A total of \$466,549 was paid for 155,334 fish documented in 12,222 sport reward vouchers during **1991** (Table 1). In general, payment of these vouchers proceeded smoothly. Sport anglers received \$3 for each squawfish that they submitted. Although the sport reward program began in May, the first data tapes containing voucher records were not received and processed until late June. Subsequent payment activity was heaviest during July and August, continuing to a lesser extent through November. In January **1992**, we issued 185 **1099** forms to anglers who were paid more than \$600 for vouchers submitted during **1991** (accounting for \$258,212 in voucher payments).

Problems encountered during payment of **1991** sport reward vouchers included the following:

- a. There were some data entry and math errors in the tapes from ODFW. Therefore, the total number of fish (multiplied by \$3.00) does not equate to the total number of dollars paid out. PSMFC will make some programmatic changes in **1992** so these errors do not re-occur (such as having the dollar amount calculate automatically from the number of fish).
- b. Some of the address and social security number information in the ODFW data tapes proved to be in error. Revisions were made where possible.

Table 1. Total number of vouchers received, total numbers of fish represented by these vouchers, and total funds paid in rewards by month during the **1991** sport reward fishery.

Month	# Vouchers	# Fish	Total \$\$
June	1,102	13,068	39,163
July	4,539	71,597	214,790
August	3,069	36,385	109,126
September	2,265	24,444	73,332
October	1,192	8,935	26,805
November	55	287	861
Manual		618	2,472
<b>TOTALS</b>	<b>12,222</b>	<b>155,334</b>	<b>\$466,549</b>

- c. It became necessary to modify our computer program to check for duplicate vouchers within the ODFW data records. We implemented a subroutine for this purpose and were able to intercept a number of duplicate vouchers before they were processed.
- d. Some anglers arrived in person to present their vouchers and demand payment. Presumably, these anglers thought that the established payment procedure was taking too long.

Tribal **Longline** Fishery

The number of vouchers and the total of payments made to **longline** fishers in **1991** was substantially lower than those made to sport fishers. A total of \$3,952 was paid for 988 fish documented in 98 **longline** vouchers (Table 2). **Longline** fishers received **\$4** per fish, with no additional hourly or daily compensation. Payment activity was heaviest during June and July, and continued into September.

Table 2. Total number of vouchers received, total numbers of fish represented by these vouchers, and total funds paid in rewards by month during the **1991** tribal **longline** fishery.

Month	# Vouchers	# Fish	Total \$\$
May	19	92	368
June	33	457	1,828
July	33	376	1,504
August	11	43	172
September	2	20	80
<b>TOTALS</b>	<b>98</b>	<b>988</b>	<b>\$3,952</b>

Table 3. Final 1991 expenditures report for the voucher payment project.

	Budget	Expenditures through 3/91
Personnel	18,826	<b>18,007.99</b>
Fringe Benefits	1,141	973.20
Supplies	1,700	<b>2,222.92</b>
Postage	4,000	<b>4,000.00</b>
Data Processing Fees	6,665	<b>6,739.50</b>
Personal Services	17,874	<b>22,500.00</b>
Capital Outlay	2,000	<b>2,000.00</b>
Reward Payments	474,449	<b>470,501.00</b>
Indirect Cost	7,745	<b>7,455.39</b>
<b>TOTAL</b>	<b>534,400</b>	<b>534,400.00</b>





SECTION II- EVALUATION

Cooperators

Oregon Department of Fish and Wildlife- Research and Development Section  
Oregon State University  
Computer Sciences Corporation





## EXECUTIVE SUMMARY

We report our results of studies to determine the extent to which northern squawfish predation on juvenile salmonids is a problem in the Columbia River basin, and to evaluate how effectively fisheries can be used to control northern squawfish populations and reduce juvenile salmonid losses to predation. These studies were initiated as part of a basin-wide program to control northern squawfish predation and reduce mortality of juvenile salmonids on their journey from natal streams to the ocean as described under Section I of this report. Modeling simulations based on work in John Day Reservoir from 1982 through 1988 indicated that if northern squawfish were exploited at a 10 to 20 percent rate, reductions in their numbers and restructuring of their populations could reduce their predation on juvenile salmonids by 50 percent or more. We evaluated the success of three test fisheries conducted in 1991, a tribal longline fishery, a sport reward fishery, and a dam angling fishery, to achieve a 20 percent exploitation rate on northern squawfish, and we gathered information regarding the economic, social, and legal feasibility of sustaining each fishery.

The evaluation team includes the Oregon Department of Fish and Wildlife Research and Development Section (ODFW-R&D), Oregon State University (OSU), and Computer Sciences Corporation (CSC). ODFW-R&D is the lead agency and has sub-contracted various tasks and activities to OSU and CSC based on expertise each brings to the evaluation. Objectives of each cooperator are

1. ODFW-R&D (Report G): Develop a system-wide index of northern squawfish predation on juvenile salmonids; evaluate the success of test fisheries in achieving targeted exploitation rates on northern squawfish populations; evaluate the response of northern squawfish populations to exploitation; and synthesize information on predation indexing and test fishery evaluation.
2. OSU (Report H): Evaluate the economic effectiveness of test fisheries for northern squawfish including the market potential of alternative northern squawfish products; develop and evaluate a system for collecting, storing, and distributing northern squawfish harvested by test fisheries; and evaluate the social and legal feasibility of test fisheries.
3. CSC (Report I): Use the Columbia River Ecosystem Model (CREM) to project multi-season, reservoir-specific salmonid mortality as dependent upon type and amount of predator fisheries and use CREM to project long-term, system-wide salmonid mortality as dependent upon type and amount of predator fisheries and response of predator population to exploitation.

Background and rationale for the study can be found in Report A of our 1990 annual report (Vigg et al. 1990).

Highlights of results of our work by report are:

## Report G

1. Of reservoirs sampled during 1990, density of northern squawfish with fork lengths  $\geq 250$  mm was highest in Bonneville Reservoir. However, because of its large size, abundance of northern squawfish was greatest in John Day Reservoir. Of reservoirs sampled during 1991, density was highest in Little Goose Reservoir; but again, John Day Reservoir appeared to contain the most northern squawfish. Density of northern squawfish was generally highest in boat restricted zones near dams, but abundance was higher in the much larger areas outside the boat restricted zones.

2. Because of differences in abundance and consumption, relative predation on juvenile salmonids by northern squawfish varied among reservoirs and time of year. During 1990, predation was highest in John Day Reservoir, especially during the summer. Predation also varied among areas within reservoirs and time of year. During spring of 1990, predation was greatest in the areas of John Day and McNary reservoirs outside boat restricted zones. During summer, predation was greatest within tailrace boat restricted zones of John Day and McNary dams.

3. In John Day Reservoir during 1990, estimates of exploitation of northern squawfish were 3.3% by the dam hook-and-line fishery, 1.7% by the recreational-reward fishery, and 0.7% by the tribal long-line fishery. The 3 fisheries collectively exploited 5.7% of the northern squawfish population in John Day Reservoir. Exploitation by dam hook-and-line fisheries was 2.6% in Bonneville Dam tailrace, 3.2% in The Dalles Reservoir, 3.3% in John Day Reservoir, and 2.2% in McNary Reservoir.

4. Estimated exploitation rates of northern squawfish during 1991 varied among fisheries and reservoirs. Weighting the exploitation rate in each reservoir by its corresponding abundance index and summing the weighted rates across reservoirs yielded an exploitation rate for the entire system of 10.7% (recreational-reward = 4.3%, dam hook-and-line = 6.4%). This estimate was similar to a system-wide estimate calculated from pooled data from all reservoirs of 11.2%.

5. Because of incomplete mixing of northern squawfish marked at dams, exploitation by the recreational-reward fishery may actually be approximately 2.5 times greater than estimated. Using adjusted estimates of exploitation by the recreational-reward fishery and weighting the exploitation rate in each reservoir by its corresponding abundance index yielded an adjusted exploitation rate for the entire system of 16.6% (recreational-reward = 10.2%).

6. Estimates of exploitation rates of northern squawfish by the recreational-reward fishery may be very conservative because marked fish were probably not distributed over the entire area where recreational-reward fishing occurred. Recreational-reward fishing occurred in the lower Columbia River well downstream from Bonneville Dam, and in the Snake River well upstream from Lower Granite Dam. However, it is unlikely fish marked at or near Bonneville Dam or at Lower Granite Dam were fully vulnerable to fisheries in either of these areas. Correspondingly, exploitation rates downstream from Bonneville Dam and upstream of Lower Granite Dam were probably much higher than estimated. Because estimates in 2 of 9 areas are low, and because one of

these areas (downstream from Bonneville Dam) contributed the highest catch, a system-wide exploitation rate of northern squawfish by the recreational-reward fishery may be as much as one-third higher than the adjusted estimate of 10.2%.

7. During 1990, the tribal long-line fishery was the most selective for large northern squawfish. During 1991, mean fork length of fish caught by the tribal long-line and dam hook-and-line fisheries was equal. The mean fork length of northern squawfish harvested by the recreational-reward fishery was less than either of the other fisheries. The greatest size range of northern squawfish was collected during index sampling. This confirms the importance of index sampling for collecting representative abundance and biological data.

8. Mean estimated fecundity for 124 female northern squawfish collected from all areas during 1990 was 18,501 developed eggs. Estimates ranged from 5,478 (fork length = 398 mm) to 41,322 (fork length = 449 mm).

9. We aged northern squawfish to 14 years old. Age composition was similar among reservoirs, except for an apparently large number of two-year-old fish present in McNary Reservoir in 1990. Mean backcalculated fork lengths at age were also similar among reservoirs. Weight versus fork length relationships were similar among reservoirs; however, the slopes of the weight-length equations for fish in Bonneville and John Day reservoirs were relatively low. Annual mortality rates were similar among reservoirs except for John Day Reservoir, where annual mortality was lowest.

10. Trolled lures were very selective for large northern squawfish. We caught 1168 northern squawfish during 864 lure-hours in 1991. Catch rates increased from May through July and then declined. Our total incidental catch for the entire season consisted of one smallmouth bass and one steelhead.

11. Catch rates of northern squawfish by lure-trolling in 1991 were high near juvenile salmonid bypass outlets. Sampling in other areas of Bonneville Dam tailrace and forebay produced very low catch rates. Lure trolling can achieve very high catch rates in areas where and at times when juvenile salmonids concentrate and attract large numbers of northern squawfish. Catch rates of northern squawfish near juvenile salmonid bypass outlets during 1991 ranged from more than thirty per hour to almost zero. It appears lure trolling could most efficiently be used as a supplemental removal method during periods when northern squawfish are concentrated in a relatively small area, such as near a juvenile salmonid bypass.

## Report H

1. Results of tests for dioxin accumulation in the flesh and organs of northern squawfish have still not been received. Planning for long term utilization of northern squawfish as food fish rests on sufficiently low levels of dioxin contamination.

2. The three test fisheries were compared based on their respective economic performance. All three fisheries had costs associated with monitoring activities of participants, providing incentive or compensation for participation, and operations needed to conduct the fisheries. Not including

the costs of processing voucher payments because this information is not yet available, preliminary analysis of expenditures involved in the three test fisheries estimated costs per northern squawfish removed as \$179.58 by the tribal long-line fishery, \$19.48 by the dam hook-and-line fishery, and \$6.06 by the recreational-reward fishery.

3. The system for collection, storage, and distribution of northern squawfish harvested in 1991 approximated systems used in commercial fish buying operations. The future scale and design of the fish handling system will depend upon the mix and scale of fisheries implemented. Mechanisms to maintain quality control of northern squawfish catch need to be improved because food utilization has the highest potential value and the most stringent quality standards. The quality control system used in 1991 was not sufficient to ensure the catch met food-quality standards.

4. Various utilization trials were performed with northern squawfish. In laboratory tests northern squawfish was found to keep well on ice without major changes in appearance, odor, and texture. However, storage properties depended on immediate icing after catch. The greatest food potential for northern squawfish appeared to be high quality minced fish products. Market tests in Northeastern U.S. locales indicate favorable market acceptance. Marketability of northern squawfish as a food fish is likely to be sensitive to its price compared to substitute species. The quality of northern squawfish as fish meal was good and was similar to carp. Northern squawfish also performed well as grizzly bear bait, in the production of liquid fertilizer, and as mink feed.

5. A poor market for Columbia River American shad limited use of its bycatch by northern squawfish fisheries to bait or as a component of animal feed. Undesirable market attributes of American shad included a strong odor, unusual appearance, and bony skeleton.

6. Several social issues affecting participation in and conduct of the test fisheries were identified. Factors contributing to low participation in the tribal long-line fishery included objections to the amount of paperwork, the level of oversight, competition with other fisheries, weekend conflicts with sport anglers, and difficulties covering operating costs. Issues associated with the recreational-reward fishery included those associated with the registration, data collection, and check-in process, conflicts between anglers and other water users, and crowding at boat ramps. The dam hook-and-line fishery was characterized by few fishery-wide problems.

7. We have begun consultations with appropriate parties concerning processes necessary to address legal and regulatory concerns associated with development of a northern squawfish control program that were identified in our 1990 survey. These issues are

a. a need to determine effects of full-scale fisheries on incidentally caught fish species, especially salmon and steelhead, and especially in light of recent recommendations to list some populations as threatened under the Endangered Species Act;

b. a need for review of plans for commercial fisheries between Bonneville and McNary dams by tribal and state managers and governing bodies and formal sanction by U.S. v Oregon parties;

- c. a need for reclassification of northern squawfish by the State of Washington as a food fish;
- d. a need to better define and address regulatory responsibilities and social considerations associated with development of commercial fisheries;
- e. a need to review and interpret regulations by Oregon Washington and Idaho prohibiting compensation of sport anglers for catch in' context of the recreational-reward fishery;
- f. a need to examine effects of issues related to ownership and use of access sites along the Columbia and Snake rivers on participation in the recreational-reward fishery; and
- g. a need to identify and address safety and security issues related to access to federal projects for the dam hook-and-line fishery.

8. Additional analyses will be conducted as data are summarized and will be included in future progress reports. These include analyses of tribal long-line fishery trip and fishery observer data, recreational-reward fishery voucher and non-returning angler survey data, dam hook-and-line fishery cost per project data, and enforcement personnel survey data.

## Report I

1. Parameters which describe the relationship between catch and fishing effort for northern squawfish for a given population size were incorporated into the Columbia River Ecosystem model (CREM). These parameters enable determination of catchability coefficients using observed catch rates and known fishing effort by gear and reservoir area. Catchability coefficients are used to describe changes in northern squawfish populations caused by the test fisheries. The criterion for determination is a set of coefficients which produce simulated catch patterns over time which are as close as possible to those which were observed.

2. Water temperature was determined to have a significant effect on catch rate, so this effect and a temperature control parameter were included in CREM. Using a Parameter Estimation Procedure (PEP), these parameters were examined to determine if different values would improve the goodness-of-fit of predicted to observed catch data. PEP was also used to determine if different estimates of northern squawfish population size and distribution in the reservoir would improve the goodness-of-fit of predicted to observed catch data because of the uncertainty in these estimates.

3. PEP/CREM was employed to determine the best catchability coefficients for the 1990 test fisheries. PEP/CREM was able to improve the average error in simulating each week's fishery catch from 3.2 percent to 1.1 percent of the total northern squawfish catch of 10,000 fish. Catch errors ranged from 51 percent to 2 percent for the 13 gear and reservoir area combinations examined. The mean error over all fisheries, weighted by total fish catch, was 11 percent.

4. Use of the temperature effect parameter, as opposed to the previous CREM version without it, resulted in a 27 percent improvement of the catch error. However, PEP/CREM was unable to improve the catch error significantly by variation in the initial northern squawfish population size estimate or the estimates of northern squawfish distribution by reservoir area.

5. Simulations with the optimized parameter values did not result in significant changes in juvenile **salmonid** mortality estimates. Using PEP/CREM, confidence limits for juvenile **salmonid** mortality estimates may now be determined.







REPORT G

Development of a System-Wide Predator Control Program: Indexing, Fisheries  
Evaluation, and Harvesting Technology Development

Prepared by

David L. Ward, Mark P. Zimmerman, Robert M. Parker, and Scott S. Smith  
Oregon Department of Fish and Wildlife  
Research and Development Section



## CONTENTS

	<u>Page</u>
ACKNOWLEDGMENTS. . . . ."	347
ABSTRACT . . . . .	348
INTRODUCTION . . . . .*	349
METHODS . . . . .	350
Field Procedures . . . . .	350
Predation Index . . . . .	350
Fishery Evaluation . . . . .	350
Lure Trolling . . . . .	352
Laboratory Procedures . . . . .	352
Data Analysis . . . . .	353
Predation Index . . . . .	353
Fishery Evaluation . . . . .	355
Relative Efficiency . . . . .	355
Baseline Biological Data . . . . .	356
Lure Trolling . . . . .	357
RESULTS . . . . .	357
Predation Index . . . . .	357
Fishery Evaluation . . . . .	360
Relative Efficiency . . . . .	360
Baseline Biological Data . . . . .	366
Lure Trolling . . . . .	375
DISCUSSION . . . . .	375
REFERENCES . . . . .	393
APPENDIX G-1. Size distribution of tagged and recaptured northern squawfish . . . . .	395
APPENDIX G-2. Mark and recapture data used to estimate exploitation of northern squawfish . . . . .	399
APPENDIX G-3. Tables of backcalculated lengths, age at length keys, and von Bertalanffy growth parameters . . . . .	413



## ACKNOWLEDGMENTS

This research was funded by Bonneville Power Administration, William Maslen, Project Manager (Contract **DE-BI79-90BP07084**). Anthony A. Nigro and Charles F. Willis of the Oregon Department of Fish and Wildlife administered the contract and critically reviewed the manuscript. We thank Thomas P. Poe and his staff, U. S. Fish and Wildlife Service; Susan Hanna and Jon **Pampush** and their staffs, Oregon State University; Steven B. Mathews and Tom Iverson and their staffs, University of Washington; L. J. (Sam) Bledsoe, Computer Sciences Corporation; Greg Hueckel and Craig Burley and their staffs, Washington Department of Wildlife, Earl Dawley, Bruce Monk and Bill Muir, National Marine Fisheries Service; and Christine Mallette and her staff, Oregon Department of Fish and Wildlife for their cooperation and help with project coordination.

The U. S. Army Corps of Engineers was very cooperative in the use of their project facilities. We especially thank the following **USACE** personnel for help with coordination: Jim Kuskie, Jim Williams, Gary Dunning, Brad Eby, Susan Shampine, Larry Walker, Dave Hurson, Rex Baxter, Garth Griffin, and John **McKern**.

Special thanks go to the project personnel that worked long hours in the field to collect the data presented in this report. Thanks to Kent Anderson, Karen Walker, Stacie **Rimbach**, and Dennis Schwartz for assisting with summaries of data collected during 1990 and with collecting data during 1991. Thanks also to the following people for assisting with data collection during 1991: Phil Archibald, Ken Espersen, Teckla Gotreau, Kim Jackson, David Neely, John Harrison, David Van Schoiack, Candi Healy, Robert Mueller, George Reed, Tom Adams, Ken Collis, Stephen Morrow, Mike Royle, Tom **Friesen**, Tom Neill, John Donnerberg, Roger Berreth, **Vicki** Royle, and Rebecca **Backman**.

## ABSTRACT

We are reporting progress on predation indexing, fisheries evaluation, and development of harvest technology as part of the northern squawfish *Ptychocheilus oregonensis* predator control study in the lower Columbia and Snake rivers for 1991. We are also reporting results from 1990 sampling not previously reported. Our objectives for 1991 were to (1) continue **system-wide, stepwise** implementation of the predation index, (2) initiate evaluation of test fisheries in the Columbia River basin as they are implemented, and (3) evaluate harvest technology of lure trolling for northern squawfish.

We sampled with **gillnets** and an electrofishing boat to develop an index of northern squawfish abundance for lower Columbia River (1990) and Snake River (1991) reservoirs. The abundance index was integrated with a consumption index developed by the U.S. Fish and Wildlife Service to produce a predation index. Results from each reservoir were compared to those from John Day Reservoir. Of reservoirs sampled during 1990, Bonneville Reservoir appeared to contain the highest density of northern squawfish  $\geq 250$  mm fork length; however, abundance and predation were highest in John Day Reservoir. Of reservoirs sampled during 1991, density was highest in Little Goose Reservoir; but again, abundance and predation were highest in John Day Reservoir.

We evaluated the efficiency of three test fisheries (public sport reward, agency dam angling, and tribal commercial longline) by comparing northern squawfish exploitation rates and size composition among fisheries. **System-wide** estimates of exploitation rate during 1991 varied from 10.0 to 14.8% (all fisheries combined) depending upon whether we used one or two years of fish marking data, and on assumptions regarding the degree of mixing throughout reservoirs of marked fish released at dams. Using all available data, and adjusting for incomplete mixing of marked fish, we estimated exploitation of northern squawfish during 1991 to be 10.8% by the sport reward fishery, 3.6% by dam angling, and 0.4% by commercial longlining.

There appeared to be a trade-off among fisheries concerning number and size of fish removed. The mean fork length of fish caught in the sport reward fishery (333-377 mm) was lower than in other fisheries (414-429 mm).

We also collected and analyzed data on northern squawfish population structure, fecundity, age and growth, and mortality. This data, as well as information on community structure, will be compared to similar data collected after sustained (3-5 years) fisheries.

We trolled lures in Bonneville Dam **tailrace** to evaluate the feasibility of using lure trolling as a northern squawfish removal fishery. Results indicated that lure trolling could most efficiently be used as a supplemental removal method during periods when northern squawfish are concentrated in a relatively small area, such as near a juvenile **salmonid** bypass.

## INTRODUCTION

We began implementation of a predation index, predator control fisheries, and an evaluation plan for lower Columbia River reservoirs in 1990. During 1991, our activities were expanded to include reservoirs in the lower Snake River. We reported first year progress in our 1990 annual report (Vigg et al. 1991). In this report we describe our activities and results during 1991. Also included in this report are summaries and analyses of data collected during 1990, but due to reporting requirements, not included in the 1990 report. Further background information can be found in our 1990 report (Vigg et al. 1991).

The goal of predator control is to reduce in-reservoir mortality of juvenile salmonids due to predation by northern squawfish *Ptychocheilus oregonensis*. Our objectives during 1991 were to (1) continue system-wide, **stepwise** implementation of the predation index, (2) initiate evaluation of test fisheries in the Columbia River basin as they are implemented, and (3) evaluate harvest technology of lure trolling for northern squawfish.

The predation index is a product of a northern squawfish abundance index and a consumption index (Vigg et al. 1991). We collected data on northern squawfish abundance in lower Columbia River reservoirs in 1990, and in lower Snake River reservoirs in 1991. The U.S. Fish and Wildlife Service (USFWS) collected data on consumption of juvenile salmonids by northern squawfish in the same areas both years. The envisioned product of the predation index is an assessment of the magnitude of predation in various reservoirs throughout the Columbia River basin relative to baseline data in John Day Reservoir. This would allow direction of predator control fisheries to places where predation is greatest.

Evaluation is necessary to compare relative efficiencies among predator control (test) fisheries and to determine biological effects of the fisheries. During 1990 and 1991, fisheries included dam angling, sport reward, and commercial longline. Evaluating efficiency of the fisheries includes comparing catch rates of northern squawfish and incidental species, comparing northern squawfish exploitation rates, and comparing size composition of the northern squawfish catch among fisheries. Modeling simulations have shown that about 20% exploitation of northern squawfish larger than 275 mm fork length by sustained fisheries could reduce juvenile salmonid losses to predation by about 50% (Rieman and Beamesderfer 1990).

Biological evaluation includes comparing northern squawfish population structure, fecundity, age and growth, and survival before and after sustained (approximately five years) fisheries. Community structure (relative abundance of other fish species) will also be compared.

Trolling lures to collect northern squawfish is one of many possible alternatives or additions to the predator control fisheries. The efficiency of lure trolling may be evaluated similarly to the existing fisheries.



## METHODS

### Field Procedures

#### Predation Index

We used an electrofishing boat, bottom gillnets, and surface **gillnets** to collect northern squawfish and develop the abundance index portion of the predation index. During 1990 we sampled five areas: (1) Bonneville Dam tailrace, (2) Bonneville Reservoir, (3) The Dalles Reservoir, (4) John Day Reservoir, and (5) McNary Reservoir (including Ice Harbor Dam tailrace). During 1991 we also sampled five areas: (1) John Day Reservoir, (2) Ice Harbor Reservoir, (3) Lower Monumental Reservoir, (4) Little Goose Reservoir, and (5) Lower Granite Reservoir (Figure G-1). Each reservoir was divided into lower (forebay), mid, and upper (tailrace) areas. **Forebay** and **tailrace** areas were further divided into boat restricted (BRZ) and non-boat restricted zones. We sampled each area during two segments of the juvenile **salmonid** out-migration: early (May-July) and late (July-September). Gillnetting was conducted by ODFW, whereas electrofishing was conducted by both ODFW and USFWS. Sampling schedules and methods, effort, and gear specifications during 1990 were described by Vigg et al. (1991). Other than areas sampled, effort during 1991 was similar to that in 1990.

The USFWS also collected data to develop the consumption portion of the predation index. They examined stomach contents of northern squawfish collected during their sampling. Details of their methods are given in Petersen et al. (1991).

#### Fishery Evaluation

The predator control fisheries (dam angling, sport reward, and commercial longline) were described by Vigg et al. (1991). During 1990, dam angling was conducted from April through August at Bonneville, The Dalles, John Day, McNary, and Ice Harbor dams, and the sport reward (late May-early September) and commercial **longline** (mid June-early August) fisheries were conducted in John Day Reservoir (Figure G-1). During 1991, dam angling was conducted from May through September at the same dams as well as Lower Monumental, Little Goose, and Lower Granite dams. The sport reward fishery was conducted from late May through late September below Bonneville Dam and in Bonneville, John Day, Little Goose, and Lower Granite reservoirs, and from mid July through late September in The Dalles, McNary, Ice Harbor, and Lower Monumental reservoirs. The commercial **longline** fishery was conducted from mid May through late September in Bonneville Reservoir, and from mid June through late September in The Dalles and John Day reservoirs (Figure G-1). We collected biological data from a subsample of northern squawfish caught in these fisheries during both years. We measured fork length (mm) and weight (g), we determined sex and maturity (undeveloped or immature, developing, ripe, or spent) of fish not tagged and released, and we collected scale samples and gonad samples (ripe females only) from fish not tagged and released. During index sampling, we also collected baseline biological data on northern squawfish populations. Data collected was similar to that described for the predator control fisheries. In addition to the areas sampled for the abundance index, during 1991 we sampled in Bonneville Dam **tailrace** and Bonneville Reservoir to collect biological data after one season of fishing (dam angling only).

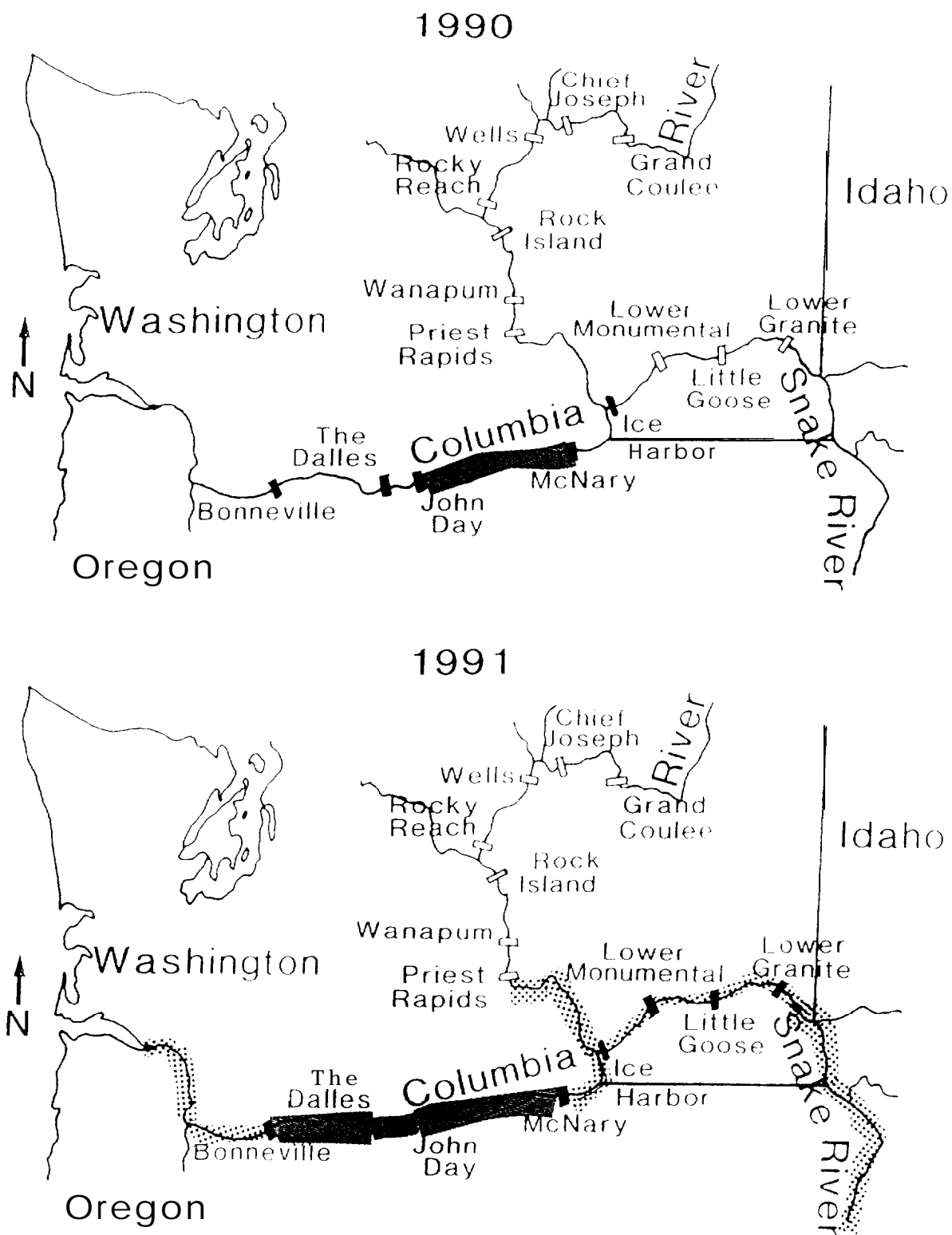

Figure G-1. Reservoirs and dams (labeled) at which predator control fisheries were conducted during 1990 and 1991. Dam angling was conducted at dark-colored dams. Densely-highlighted reservoirs indicate areas where both sport reward and commercial longline fisheries were conducted. Areas highlighted by dots are where the sport reward fishery only was conducted.

We tagged some northern squawfish to evaluate northern squawfish movements and compare exploitation rates among fisheries. Primarily, fish tagged were those caught by dam anglers. During 1990, two-week periods in which fish caught by dam anglers were tagged and released alternated with two-week periods in which fish were removed. During 1991, a subsample of fish caught by dam anglers each day were tagged and released. Fish were tagged with a serially numbered spaghetti tag. During 1990, we clipped the left pelvic fin of tagged fish; during 1991 we clipped the right pelvic fin.

During 1991 we tagged fish captured during index sampling in Bonneville Reservoir to better evaluate northern squawfish movements. During 1991 we also tagged northern squawfish collected during harvest technology tests conducted by the National Marine Fisheries Service near Bonneville Dam, and the University of Washington near the Dalles Dam. We also tagged some northern squawfish collected during lure trolling in Bonneville Dam tailrace.

### Lure Trolling

We collected northern squawfish by trolling lures in Bonneville Dam tailrace from late August through early October during 1990, and from May through September during 1991. Sampling gear and methods were described by Vigg et al. (1991). Sampling during 1991 was limited to the six lures with the highest catch per unit effort (CPUE) during 1990 (Tennessee Shad Speed Trap, Rainbow Trout Kwikfish, Silver Shad Kwikfish, Rainbow Trout Hi-catch, Silver Blue Speed Trap, and Chrome Hot Shot; Vigg et al. 1991). We measured fork length (mm), collected scale samples, and determined sex of most northern squawfish caught.

### Laboratory Procedures

We used gravimetric quantification (Bagenal 1968) of developed and undeveloped eggs to estimate fecundity of northern squawfish in each reservoir. We examined ovaries in the field to determine relative reproductive maturity. Ripe ovaries were placed in Gilson's solution and allowed to fix for a minimum of four weeks. Ovary samples were then prepared for analysis as described by Vigg et al. (1991). Ovary subsamples were weighed and egg counts in the subsamples were extrapolated to total ovarian weight. To assure accurate egg production estimates, only counts of developed eggs, characterized by their relatively large size and yellow or orange color, were used in calculating fecundity estimates and relationships with length and weight.

Scale samples from northern squawfish collected primarily during index sampling were used in age determination. When needed, we supplemented sample sizes with scales from fish collected during predator control fisheries. For each reservoir, samples from 10 individuals (5 male and 5 female) were randomly selected from each 25-mm length group. If the initial random sample was not comprised of equal numbers of males and females, it was supplemented to obtain 5 samples from each sex if possible. Scale collection and aging techniques followed established methods (Jearld 1983, Vigg et al. 1991).

## Data Analysis

### Predation Index

Prior to 1990 sampling, various catch rate indices were evaluated to determine their ability to accurately reflect differences in northern squawfish abundance (Vigg and Burley 1991). Two indices, the square root of the percent of zero catches (percent-0), and the natural logarithm of non-zero catches (Ln non-0) were shown to be good indicators of relative abundance (Vigg and Burley 1991).

Before applying the indices to 1990 catch data, we tested their ability to accurately reflect changes in northern squawfish abundance in John Day Reservoir from 1984 through 1986. Northern squawfish abundance in John Day Reservoir was estimated for each year from 1984 through 1986 by mark and recapture techniques (Beamesderfer and Rieman 1988). We used changes in each index, as well as changes in catch per unit effort (CPUE) among years to predict changes in abundance among years:

$$\text{Index year a} / N \text{ year a} = \text{Index year b} / N \text{ year b}$$

where

**Index** year a = catch index during year of known abundance (base),  
**Index** year b = catch index during year abundance is being predicted,  
**N** year a = abundance (known) during base year, and  
**N** year b = abundance (predicted) during year b.

Because data from each year were used to predict abundance during the other two years, each index was used to calculate six abundance estimates for each gear used (electrofishing and bottom gillnets). We then used linear regression (SAS Institute, Inc. 1987) to compare the percent changes in abundance predicted by each index to the percent changes determined by the mark and recapture study. If the predicted changes were equal to the actual changes, then the regression line would have a slope of one and pass through the origin.

Changes in electrofishing catch indices were better indicators of changes in abundance than changes in bottom gillnet catch indices. Although abundance increased each year from 1984 through 1986 (1984 = 68,947, 1985 = 84,114, and 1986 = 102,888; Beamesderfer and Rieman 1988) gillnet catch indices predicted a decrease in abundance. Of the three electrofishing catch indices, Ln non-0 and CPUE were the best indicators of change in abundance (Table G-1). The percent-0 index predicted 1985 abundance to be higher than 1986.

Regression analysis indicated that the two indices were nearly equal in their ability to accurately predict changes in abundance. Regression of changes in abundance predicted by Ln non-0 on observed changes in abundance was significant ( $P < 0.01$ ,  $r^2 = 0.94$ ). The slope and intercept of the

Table G-1. Observed (as determined by mark and recapture) and predicted changes in northern squawfish abundance in John Day Reservoir, 1984-1986.

Base year	Predicted year	Observed change	Predicted change	
			Ln non-0	CPUE
1984	1985	22.0	42.0	21.8
	1986	49.2	63.4	73.7
1985	1984	-18.0	-29.6	-17.9
	1986	22.3	15.1	42.6
1986	1984	-33.0	-38.8	-42.4
	1985	-18.2	-13.1	-29.9

regression line were 1.24 and 1.47. Regression of changes predicted by CPUE was also significant ( $P < 0.01$ ,  $r^2 = 0.97$ ), with a slope and intercept of 1.41 and 2.26. Predicted abundance was always within the 95 percent confidence intervals of the actual abundance (Beamesderfer and Rieman 1988).

The next step was to use the two electrofishing catch indices to estimate abundance of northern squawfish in John Day Reservoir during 1990:

$$\text{Mean Index } 84-86 / \text{Mean N } 84-86 = \text{Index } 90 / \text{N } 90$$

where

Mean Index 84-86 = Mean catch index 1984 through 1986,  
 Mean N 84-86 = Mean abundance 1984 through 1986,  
 Index 90 = Catch index for 1990, and  
 N 90 = Predicted 1990 abundance.

The two catch indices predicted quite different abundances for 1990. Predicted abundance using the CPUE index was 144,202, whereas predicted abundance using the Ln non-0 method was 107,219.

Although the difference between the two predictions is large, it may not be significant. Vigg and Burley (1991) showed that with a sample size similar to that of 1990, CPUE demonstrated a 90% probability of estimating the true CPUE within 50%, whereas Ln non-0 demonstrated a 90% probability of estimating the true index within 15%. Therefore, the potential abundance as predicted by the CPUE index could be as low as 72,101, and the potential abundance as predicted by the Ln non-0 index could be as high as 123,302. Because of our limited sample sizes during 1990, and because of the results shown by Vigg and Burley (1991), we selected the Ln non-0 index (electrofishing) to use in our calculations of the abundance index.

We used differences in the Ln non-0 index among reservoirs during 1990 and 1991 as an indicator of differences in density of northern squawfish. An index of northern squawfish abundance was calculated as a product of density

and reservoir size (surface area). Deep (>approximately 40 ft), main-channel, mid-reservoir areas were excluded when computing reservoir surface area because previous studies showed that northern squawfish occurrence in these areas was low (Nigro et al. 1985). We also used area-specific catch indices to compare density and abundance of northern squawfish among areas of all reservoirs.

The consumption index was developed by the USFWS (Petersen et al. 1991). The consumption index is not a rigorous estimate of the number of juvenile salmonids eaten per day by an average northern squawfish; however, it is linearly related to the consumption rate of northern squawfish (Petersen et al. 1991). Unlike abundance data, 1990 consumption data for Columbia River reservoirs was summarized for early (spring) and late (summer) periods. Because the majority of juvenile salmonids migrate through Snake River reservoirs during spring, 1991 consumption data was not collected during summer.

The predation index is the product of the abundance index and consumption index. The index is not an estimate of the number of juvenile salmonids consumed by northern squawfish, but differences in the index among reservoirs and reservoir areas are directly proportional to differences in predation. We compared predation indices among reservoirs during 1990 and 1991. We also used area-specific results to compare predation among areas of all reservoirs.

## Fishery Evaluation

### *Relative Efficiency*

We used mark and recapture data to compare exploitation rates of northern squawfish among areas and fisheries. We first used Chi-square analysis (SAS Institute, Inc. 1987) to determine if recapture rate was independent of fish size (see Appendix G-1). For estimates of exploitation during 1991, we evaluated movements and distribution of marked northern squawfish that were recaptured to determine the extent of mixing among marked and unmarked fish so we could define areas containing discrete populations. Because only dam angling was conducted outside John Day Reservoir during 1990, we could not use movement data to define discrete populations of northern squawfish. Exploitation estimates for 1990 were therefore not adjusted for northern squawfish movement. During 1990, all fish recaptured during the same Z-week period in which they were tagged were excluded from analyses. Exploitation was calculated for each Z-week period and summed to yield total exploitation for each fishery (Beamesderfer et al. 1987). During 1991, all fish recaptured during the same week they were tagged were excluded from analyses, and exploitation was calculated for each 1-week period and summed.

Where applicable, estimates of exploitation rates during 1991 were made using recapture data from northern squawfish marked during 1990 and 1991. We also estimated exploitation based on fish marked during 1991 only. To determine the number of fish marked during 1990 still at large during 1991, we multiplied the number of marked fish at large at the end of the 1990 sampling season by our estimate of annual survival for the appropriate reservoir or area. We then reduced the number of fish marked during 1990 at large during 1991 by our estimate of annual tag loss (16.2%). We found tag loss within a season to be negligible (~2.0%).

We also estimated system-wide exploitation by weighting exploitation rates for each reservoir by the corresponding abundance index. For each fishery, the overall exploitation rate (E) for reservoirs i through n was estimated as

$$E = \sum_{i=1}^n e_i (a_i / A)$$

where

$e_i$  = exploitation rate for reservoir i,

$a_i$  = abundance index for reservoir i, and

A = sum of the abundance indexes for the reservoirs i through n.

To help evaluate the extent of mixing of marked fish, we estimated sport reward exploitation rate of two groups of fish marked and released in Bonneville Reservoir and Bonneville Dam tailrace during 1991: (1) fish marked only during index sampling, lure trolling, or supplemental boat sampling throughout the areas, and (2) fish marked only during angling at Bonneville and The Dalles dams. Lower exploitation rate estimates of fish marked during dam angling would indicate limited mixing of these fish, and result in underestimation of sport reward exploitation rates. Limited mixing of fish marked at dams would also indicate that dam angling exploitation estimates apply to an area smaller than the entire reservoir.

We examined the size composition of the northern squawfish catch in each fishery during 1990 and 1991 to evaluate fishery selectivity for large individuals. We compared mean fork lengths and length frequency histograms among applicable fisheries, lure trolling, and ODFW electrofishing in John Day Reservoir and Bonneville Dam tailrace.

We also plotted monthly mean fork length to evaluate whether there was a decline in the size of northern squawfish harvested over time within a season. For 1990, we plotted monthly mean fork length of northern squawfish collected by angling at each dam. For 1991, we plotted monthly mean fork length of northern squawfish collected by angling at each dam, and during the sport reward fishery in each reservoir.

#### Baseline Biological Data

We calculated the proportions of female northern squawfish in various stages of sexual maturity each month from May through August during 1990 and 1991 for each reservoir. We also estimated average fecundity and average relative fecundity of northern squawfish for each reservoir. Relative fecundity was defined as the number of developed eggs per gram of total body weight. We plotted  $\log_{10}$  fecundity against  $\log_{10}$  fork length and  $\log_{10}$  body weight for each reservoir and used least squares regression analysis (SAS Institute, Inc. 1987) to determine the relationships for each reservoir.

We determined backcalculated fork lengths at formation of annuli for northern squawfish in each reservoir. This data was then used to develop age at length keys. We summarized fork lengths of northern squawfish collected during index sampling and used the age at length keys to estimate age composition for each reservoir.

We also used backcalculation data to plot length at age of northern squawfish for each reservoir. We further examined growth of northern squawfish by fitting the von Bertalanffy growth model (Ricker 1975) to estimated mean length at age. We used linear regression (SAS Institute, Inc. 1987) to examine the relationship between  $\log_{10}$  length and  $\log_{10}$  weight for each reservoir.

We used age frequencies from indexing catch data (electrofishing and gillnetting combined) to generate catch curves (Ricker 1975). We plotted  $\log(e)$  (% catch) against age to establish catch curves for each reservoir. Total instantaneous mortalities (Z) and annual mortality rates (A) were estimated by linear regression (SAS Institute, Inc. 1987) of the descending limb of the catch curves (Ricker 1975).

### Lure Trolling

We computed overall and monthly catch and CPUE of northern squawfish. We also computed catch and CPUE by lure type for the early (13 May - 19 July) and late (22 July - 23 September) seasons. We totaled the incidental catch by species. We computed monthly mean fork length of the northern squawfish catch, as well as mean fork lengths during the early and late seasons for each lure type. We determined sex ratio of the northern squawfish catch during the early and late seasons. We also calculated the CPUE of northern squawfish in each five ft depth interval fished.

## RESULTS

### Predation Index

Of reservoirs sampled during 1990, Bonneville Reservoir contained the highest density of northern squawfish with fork lengths  $\geq 250$  mm; however, because of its large size, John Day Reservoir contained the most northern squawfish (Figure G-2). Of reservoirs sampled during 1991, density was highest in Little Goose Reservoir; but again, John Day Reservoir contained the most northern squawfish (Figure G-3). Abundance in John Day Reservoir during 1991 was similar to that during 1990; therefore, abundances in Snake River reservoirs during 1991 are directly comparable to abundances in Columbia River reservoirs during 1990. Boat restricted zones contained the highest density of northern squawfish, but abundance was higher in the much larger areas outside the boat restricted zones (Figures G-4 and G-5).

Consumption rate varied among reservoirs and areas within reservoirs during both 1990 and 1991 (Tables G-2 and G-3). Because of differences in abundance and consumption, relative predation on juvenile salmonids by northern squawfish varied among reservoirs and time of year (Figures G-6 and G-7). During both 1990 and 1991, predation was highest in John Day Reservoir, especially during the summer. Because migration of juvenile salmonids through lower Snake River reservoirs occurs mostly during spring, no consumption data was collected for these reservoirs during summer of 1991. The proportion of stomach samples collected in each area varied among reservoirs (Table G-3). Therefore, we used area specific abundance and consumption indices to compute



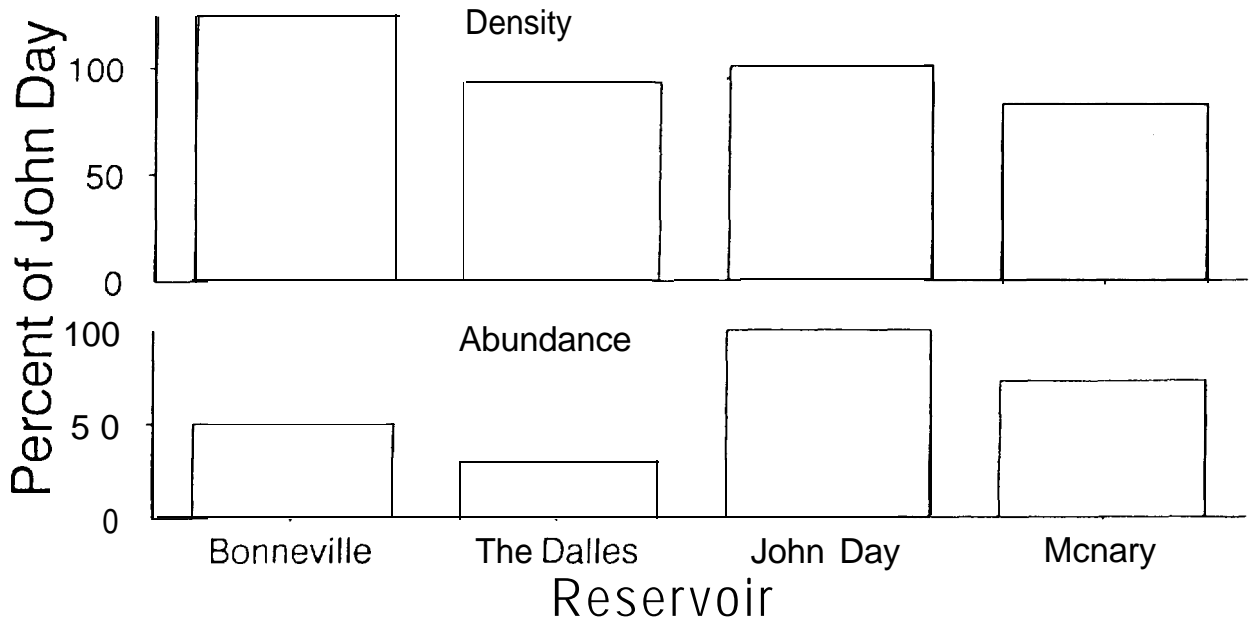

Figure G-2. Density and abundance of northern squawfish in lower Columbia River reservoirs relative to John Day Reservoir during 1990.

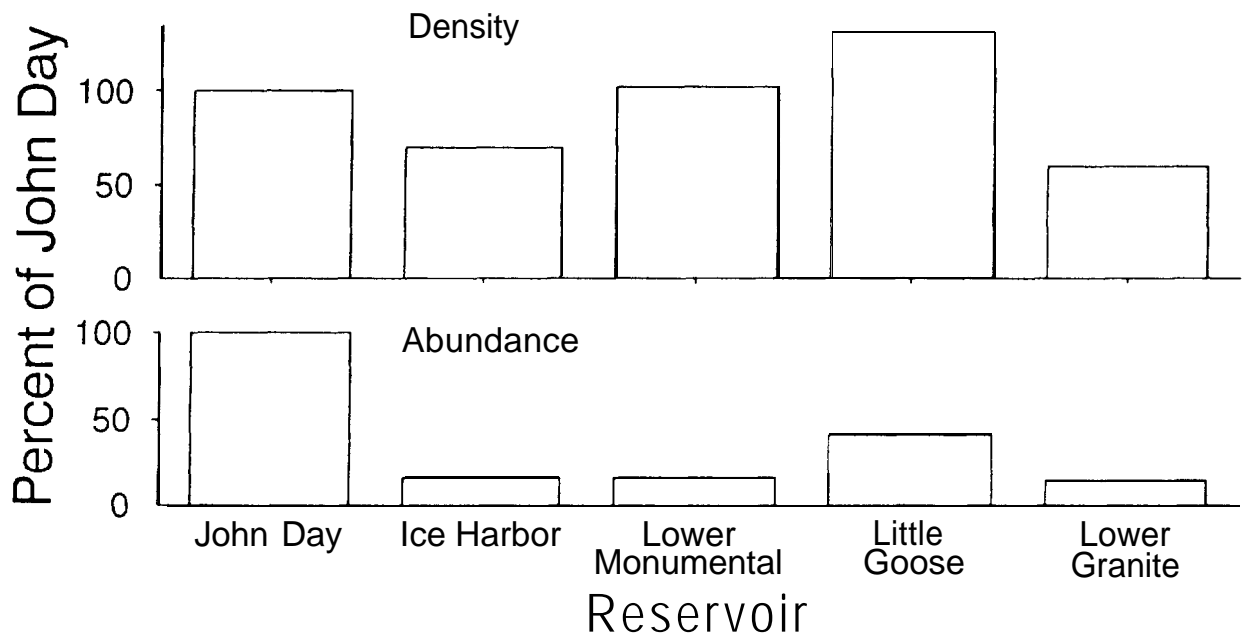

Figure G-3. Density and abundance of northern squawfish in lower Snake River reservoirs relative to John Day Reservoir during 1991.

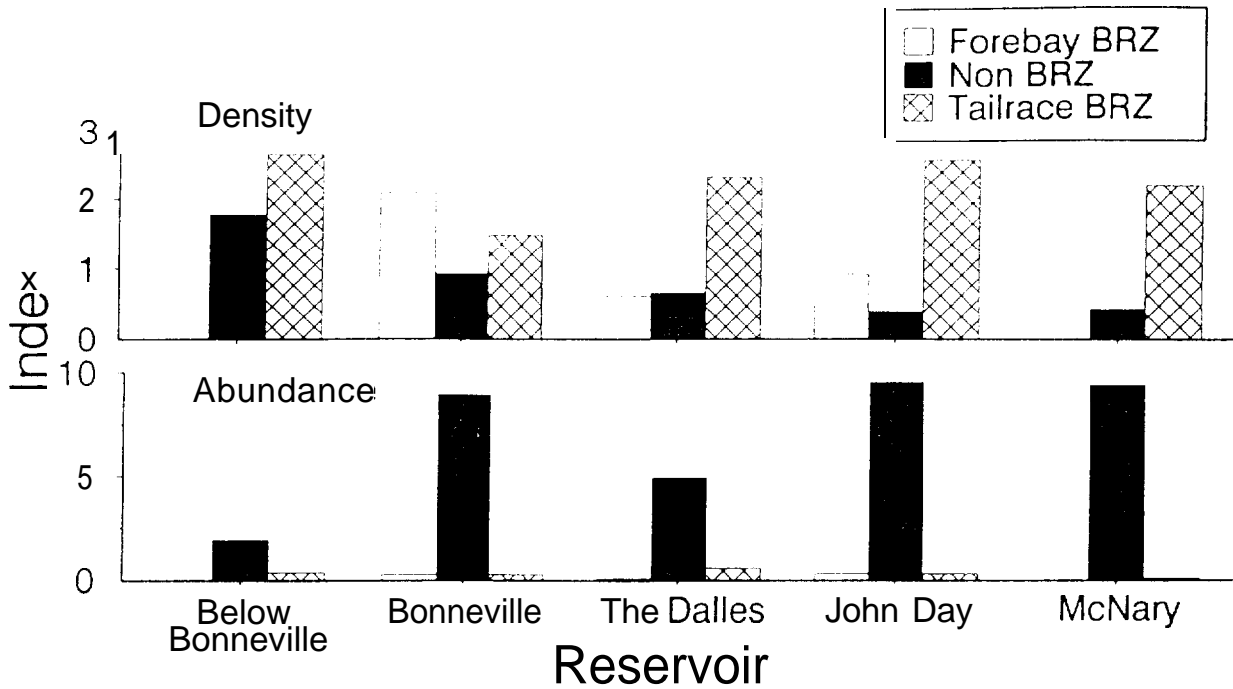

Figure G-4. Density and abundance indices of northern squawfish in the boat restricted zones (BRZ's) and the remainder of each lower Columbia River reservoir during 1990. Area below Bonneville Dam includes only the tailrace.

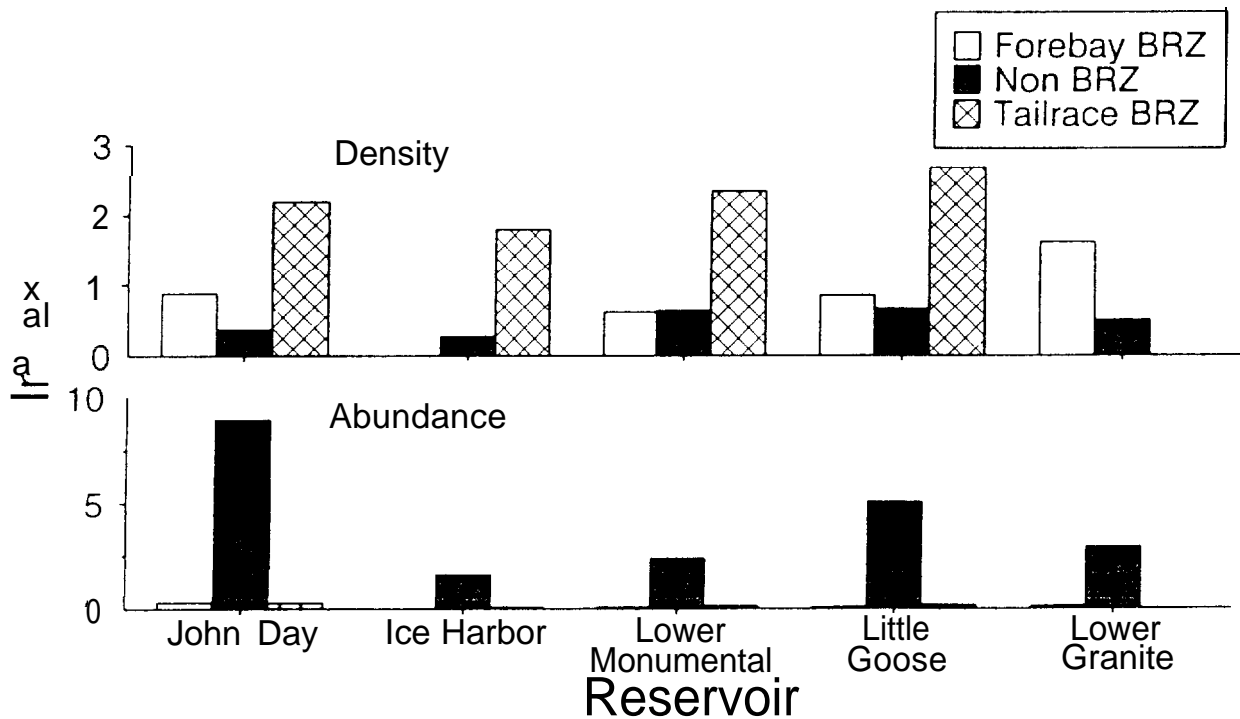

Figure G-5. Density and abundance indices of northern squawfish in the boat restricted zones (BRZ's) and the remainder of each lower Snake River reservoir and John Day Reservoir during 1991.

Table G-2. Reservoir-wide consumption indices of northern squawfish during 1990 and 1991 (summarized from Petersen et al. 1991 and 1992).

Reservoir	1990				1991			
	Spring		Summer		Spring		Summer	
	N	Index	N	Index	N	Index	N	Index
Bonneville	240	0.401	248	<b>0.790</b>	--	--	--	--
The Dalles	128	0.531	<b>208</b>	<b>1.848</b>	--	--	--	--
John Day	121	1.750	<b>98</b>	<b>5.765</b>	111	1.450	<b>120</b>	<b>2.420</b>
McNary	80	2.603	<b>170</b>	<b>0.065</b>	--	--	--	--
Ice Harbor	--	--	--	--	101	0.630	--	--
Lower Monumental	--	--	--	--	321	0.420	--	--
Little Goose	--	--	--	--	291	0.950	--	--
Lower Granite	--	--	--	--	191	0.570	--	--

a predation index for each area (Figures G-8 and G-9). Predation varied among reservoir areas and time of year. During summer of 1990, predation was highest within **tailrace** boat restricted zones of The Dalles and John Day reservoirs. At all other times, predation was highest outside the boat restricted zones, and was especially high in John Day Reservoir.

#### Fishery Evaluation

##### Relative Efficiency

During 1990, a total of 4,452 northern squawfish were marked and released at the four lower Columbia River dams and at Ice Harbor Dam. A total of 64 marked fish were recaptured in the 3 fisheries. In addition, ODFW indexing crews recaptured 2 marked fish while sampling in McNary Dam **tailrace** and Ice Harbor Dam **tailrace**, and the lure trolling evaluation crew recaptured one marked fish in Bonneville Dam **tailrace**.

Of the 67 marked fish recaptured during 1990, 10 (14.9%) had migrated between **forebay** and **tailrace** areas of particular dams. Movement between **tailrace** and **forebay** was particularly common at McNary Dam, where 6 fish marked and released in the **forebay** were subsequently recaptured in the **tailrace** (4 by dam anglers and 2 by sport anglers), and one fish marked in the **tailrace** was recaptured in the **forebay**. At The Dalles Dam, one fish moved from the **tailrace** to the **forebay**, and at Bonneville Dam, 2 fish marked in the **forebay** were recaptured in the **tailrace**.

In John Day Reservoir during 1990, exploitation was estimated to be 3.3% by dam angling, 1.7% by sport fishing, and 0.7% by longlining (see Appendix G-2). The 3 fisheries collectively exploited 5.7% of the northern squawfish population in John Day Reservoir. Exploitation by dam anglers in Bonneville Dam **tailrace** and in The Dalles, John Day, and McNary Reservoirs was **2.6%**, **3.2%**, **3.3%**, and **2.2%**, respectively. A high exploitation estimate (13.9%) in Bonneville Reservoir is biased by a single early June recapture when there were very few marked fish at large. The unusually high exploitation during this early period is misleading and contributes disproportionately to the

Table G-3. Consumption indices of northern squawfish during 1990 and 1991 at areas within reservoirs (from Petersen et al. 1991 and Shively et al. 1992). TR = tailrace, BRZ = boat restricted zone.

Reservoir, area	1990				1991			
	Spring		Summer		Spring		Summer	
	N	Index	N	Index	N	Index	N	Index
Bonneville Dam TR								
Non BRZ	<b>60</b>	<b>1.730</b>	<b>45</b>	<b>2.258</b>	--	--	--	--
BRZ	<b>89</b>	<b>2.517</b>	<b>109</b>	<b>4.578</b>	--	--	--	--
Bonneville								
<b>Forebay</b> BRZ	102	0.837	89	2.225	--	--	--	--
Non BRZ	<b>97</b>	<b>0.015</b>	<b>96</b>	<b>0</b>	--	--	--	--
<b>Tailrace</b> BRZ	<b>41</b>	<b>0.232</b>	<b>63</b>	<b>0.003</b>	--	--	--	--
The Dalles								
<b>Forebay</b> BRZ	20	0.981	25	2.767	--	--	--	--
Non BRZ	58	0.050	133	0.001	--	--	--	--
<b>Tailrace</b> BRZ	50	0.910	50	6.320	--	--	--	--
John Day								
<b>Forebay</b> BRZ	34	1.555	11	0.002	17	2.200	12	3.200
Non BRZ	<b>27</b>	<b>0.553</b>	37	0.174	<b>36</b>	<b>0.900</b>	<b>31</b>	<b>0.700</b>
<b>Tailrace</b> BRZ	<b>60</b>	<b>2.374</b>	50	11.171	55	1.500	76	2.800
McNary								
<b>Forebay</b> BRZ	17	7.807	<b>8</b>	0.007	--	--	--	--
Non BRZ	49	0.163	<b>83</b>	0.131	--	--	--	--
<b>Tailrace</b> BRZ	14	4.823	79	0.002	--	--	--	--
Ice Harbor								
<b>Forebay</b> BRZ	--	--	--	--	0	--	--	--
Non BRZ	--	--	--	--	38	0.400	--	--
<b>Tailrace</b> BRZ	--	--	--	--	63	0.800	--	--
Lower Monumental								
<b>Forebay</b> BRZ	--	--	--	--	19	0.500	--	--
Non BRZ	--	--	--	--	176	0.300	--	--
<b>Tailrace</b> BRZ	--	--	--	--	126	0.700	--	--
Little Goose								
<b>Forebay</b> BRZ	--	--	--	--	74	1.000	--	--
Non BRZ	--	--	--	--	<b>94</b>	<b>0.600</b>	--	--
<b>Tailrace</b> BRZ	--	--	--	--	<b>123</b>	<b>1.200</b>	--	--
Lower Granite								
<b>Forebay</b> BRZ	--	--	--	--	51	1.200	--	--
Non BRZ	--	--	--	--	488	0.600	--	--

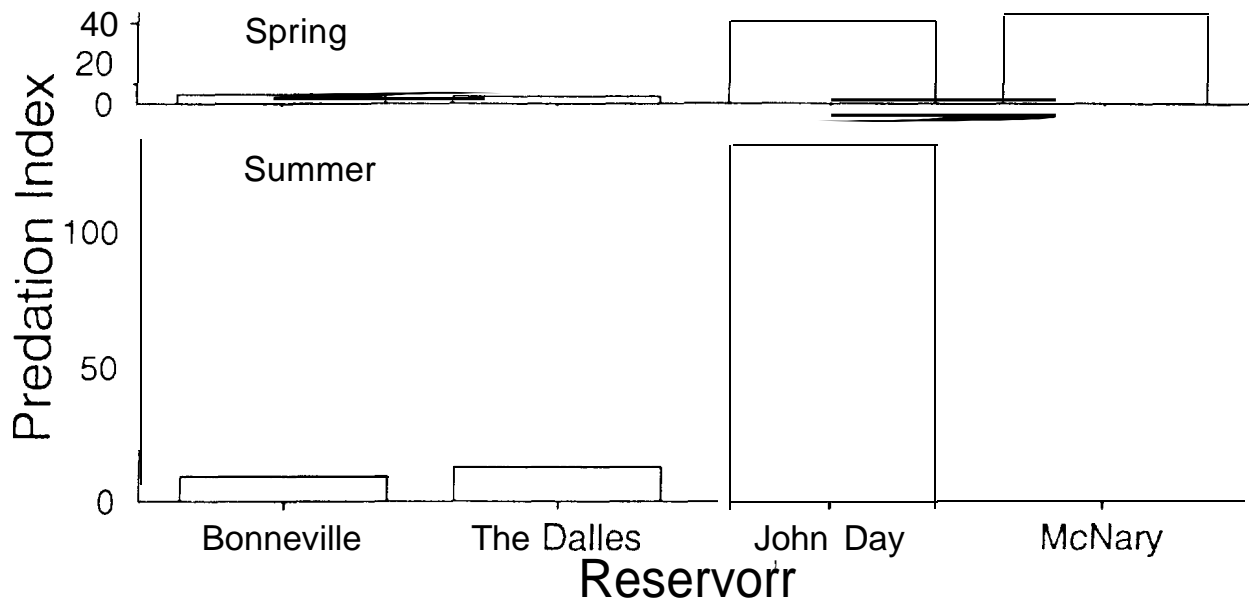

Figure G-6. Index of predation on juvenile salmonids by northern squawfish in lower Columbia River reservoirs during 1990.

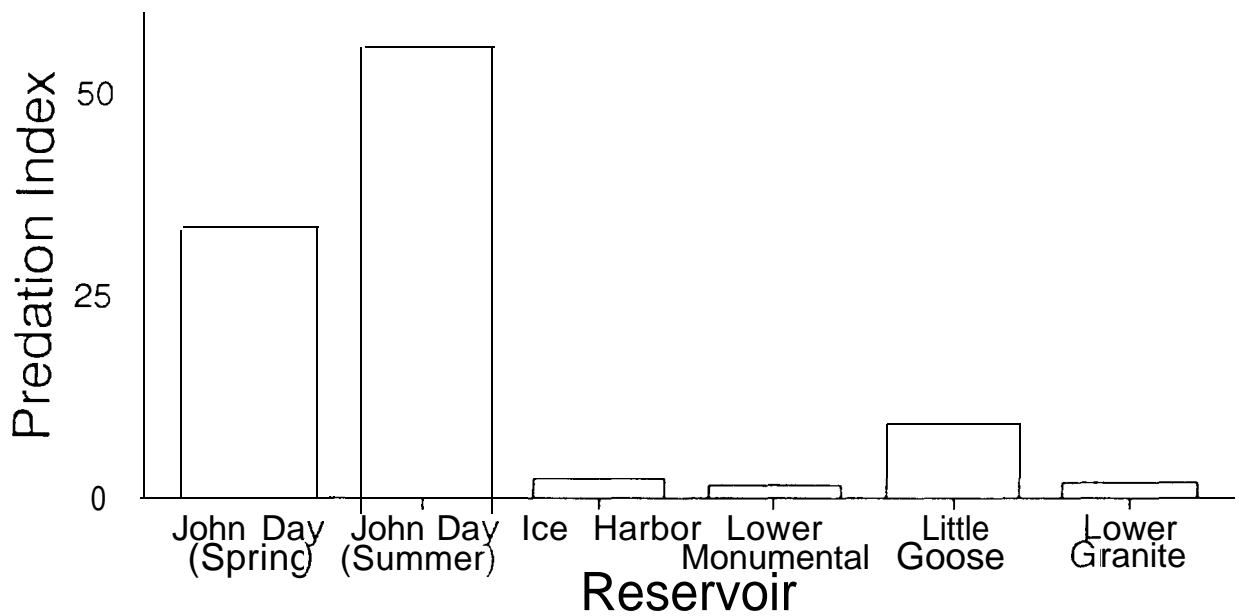

Figure G-7. Index of predation on juvenile salmonids by northern squawfish in lower Snake River reservoirs (spring only) and John Day Reservoir during 1991.

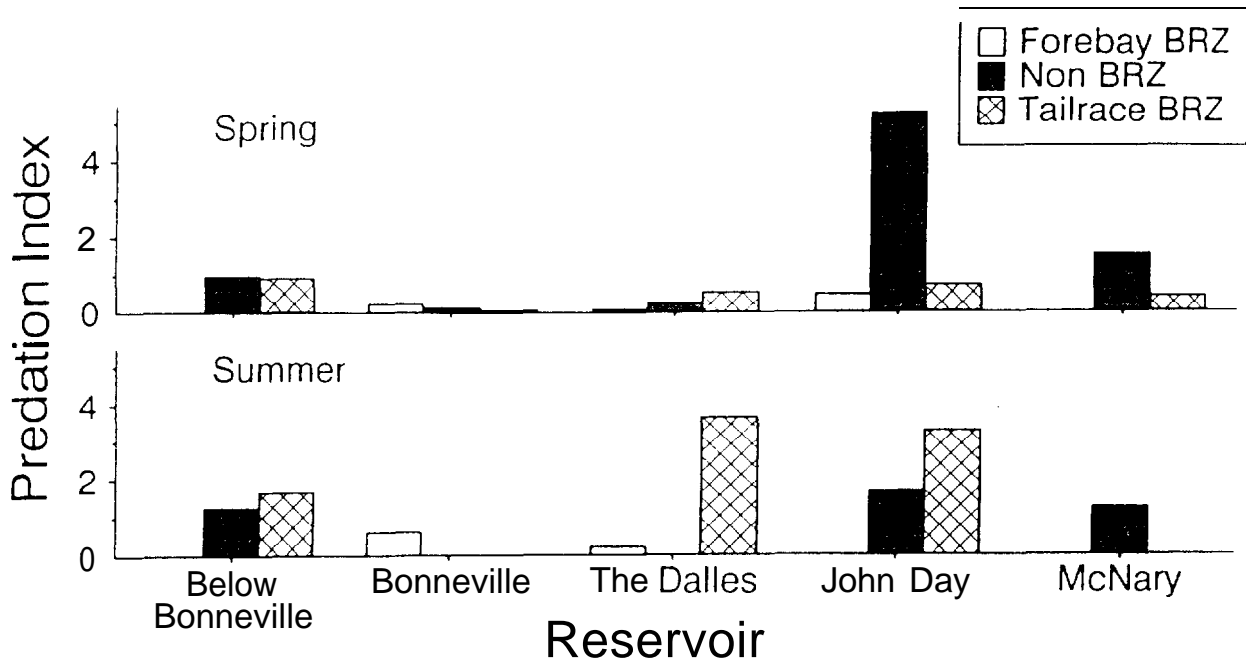

Figure G-8. Index of predation on juvenile salmonids by northern squawfish in boat restricted zones (BRZ's) and the remainder of each lower Columbia River reservoir during 1990. Area below Bonneville Dam includes only the tailrace.

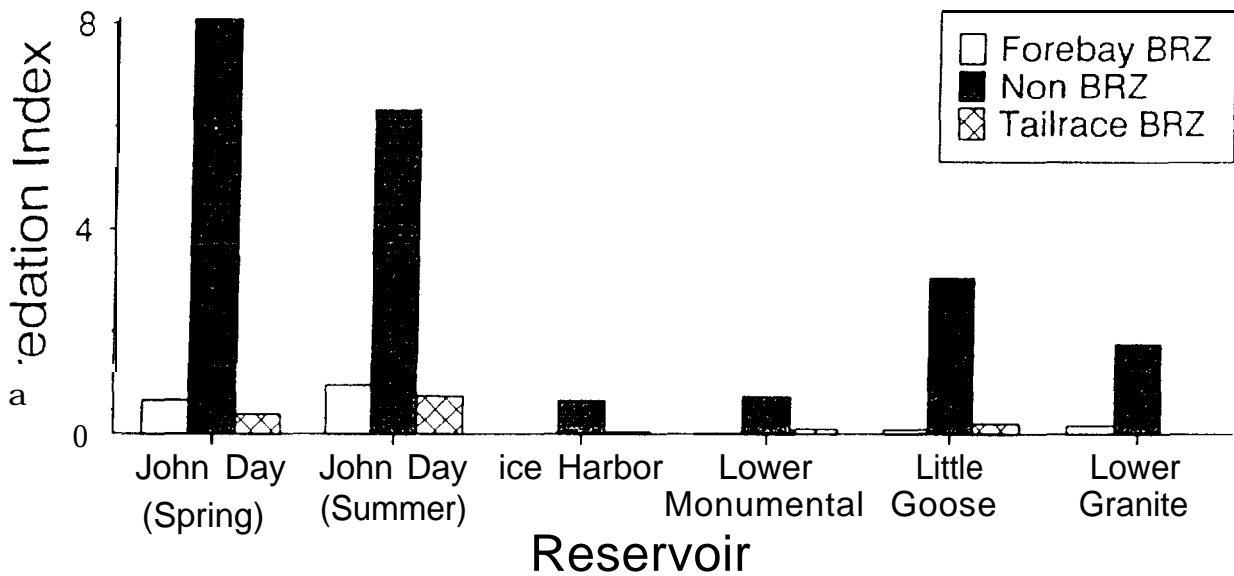

Figure G-9. Index of predation on juvenile salmonids by northern squawfish in boat restricted zones (BRZ's) and the remainder of each lower Snake River reservoir (spring only) and John Day Reservoir during 1991.

season-long estimate. Exploitation was generally greatest in **tailrace** areas; however, estimates for particular areas are limited by relatively few marked fish at large and low numbers of recaptures.

During 1991, we marked and released 7,645 northern squawfish caught by dam anglers, and an additional 1,040 fish collected during index sampling and supplemental boat sampling in Bonneville Reservoir and Bonneville Dam tailrace. Including fish marked during both 1990 and 1991, 413 northern squawfish were recaptured by dam anglers, 294 were returned by sport reward anglers, and 10 were caught during the tribal **longline** fishery. An additional 61 marked fish were caught by indexing crews, USFWS crews conducting related sampling, the lure trolling crew, the University of Washington Merwin Trap at The Dalles Dam, or by sport anglers not participating in the sport reward program.

Northern squawfish movement varied among reservoirs and areas. For most reservoirs, we found that between 90 and 100% of recaptured fish remained in the reservoir they were originally marked. No fish marked in the Snake River upstream of Ice Harbor Dam were found downstream from the dam. However, approximately 40% of the recaptures of fish marked in Bonneville and **McNary** reservoirs were in other reservoirs. Because these inconsistent results precluded easy definition of discrete populations, we estimated exploitation during 1991 for each reservoir, for the Columbia River (including the Snake River downstream from Ice Harbor Dam), for the Snake River (upstream of Ice Harbor Dam), and for the entire sampling area (designated as system-wide).

Exploitation of northern squawfish during 1991 varied among fisheries and reservoirs (Table G-4). These estimates are conservative because they exclude fish that were marked and recaptured in different reservoirs. Also, approximately 20 tag numbers were improperly recorded by sport reward personnel, were impossible to correct, and were therefore excluded from the analysis. Weighting the total exploitation rate in each reservoir by the appropriate abundance index yields an estimated total exploitation rate for the study area of 10.0%. This estimate is similar to a system-wide estimate of 11.2% (Table G-5).

Sport reward exploitation rate varied depending on where marked fish were released, indicating partial mixing of northern squawfish marked at dams with fish in the rest of the reservoir. We estimated sport reward exploitation rate of fish marked and released throughout Bonneville Reservoir and Bonneville Dam **tailrace** to be 6.4%, whereas exploitation of fish marked and released only during dam angling in Bonneville Reservoir and Bonneville Dam **tailrace** was estimated to be only 2.6%, a relative difference of approximately 250%. Because exploitation rate estimates in other areas relied exclusively on marking and releasing dam angling caught fish, sport reward exploitation rates may be as much as 2.5 times greater than our estimates that rely only on fish marked and released by dam angling (Table G-6).

Limited mixing of fish marked at dams probably also resulted in overestimates of dam angling exploitation rates. If marked fish are assumed to fully mix only within the **tailrace** or **forebay** of the dam at which they were released, dam angling exploitation estimates decrease considerably (Table G-6). Using adjusted estimates for all fisheries, and weighting total

Table G-4. Estimated exploitation rates of northern squawfish in lower Columbia and Snake River reservoirs during 1991.

Reservoir	Exploitation rate (%)			
	Sport reward	Dam angling	Commercial longline	Total
Bonneville Dam <b>tailrace</b>	6.8	3.9	--	10.7
Bonneville	1.0	2.0	0.2	3.2
The Dalles	10.1	5.2	--	15.3
John Day	1.5	9.2	0.4	11.1
McNary	2.5	0.5	--	3.0
Ice Harbor	6.9	7.4	--	14.3
Lower Monumental	8.5	4.8	--	13.3
Little Goose	7.5	13.2	--	20.7

Table G-5. Estimated exploitation rates of northern squawfish in the lower Columbia River (Bonneville Dam **tailrace** to Ice Harbor Dam), the Snake River (Ice Harbor Dam to Lower Granite Dam), and system-wide (Bonneville Dam **tailrace** to the confluence of the Clearwater and Snake rivers) during 1991.

Area	Exploitation rate (%)			
	Sport reward	Dam angling	Commercial longline	Total
Lower Columbia River	3.9	9.5	0.2	9.8
Snowy River	8.1	6.3	--	17.6
System-wide	4.7		0.2	11.2

exploitation rate in each reservoir by the abundance index, the exploitation rate for the study area (exclusive of Bonneville Dam **tailrace** and Bonneville and Lower Granite reservoirs) was approximately 10.8% by the sport reward fishery, 3.6% by dam angling, and 0.4% by commercial longlining.

Exploitation estimates from 1991 data only were similar to those using both 1990 and 1991 data. Adjusted system-wide (exclusive of Bonneville Dam **tailrace** and Bonneville and Lower Granite reservoirs) estimates of exploitation were 8.3% by the sport reward fishery, 3.4% by dam angling, and 0.6% by commercial longlining.

In John Day Reservoir during 1990, commercial longlining was the most selective gear for large northern squawfish (Figure G-10). Mean fork length of fish caught by dam angling was slightly lower than by longlining; however, the dam angling harvest was nearly 3 times greater. During 1991, dam angling catch was much greater than that by commercial longlining, and mean fork length of fish caught by the two fisheries was equal (Figure G-10). Sport anglers harvested the largest number of northern squawfish, but the mean fork length of their harvest was the smallest among fisheries. The greatest size range of northern squawfish was collected during index sampling.



Table G-6. Estimated exploitation rates of northern squawfish in lower Columbia and Snake River reservoirs during 1991. Estimates are adjusted to reflect incomplete mixing of fish marked and released at dams. Estimates for Bonneville Reservoir and Bonneville Dam **tailrace** are excluded because of frequent movement of marked fish into and out of these areas, and because fish were marked and released by a variety of methods.

Reservoir	Exploitation rate (%)			Total
	Sport reward	Dam angling	Commercial longline	
		<b>2.9</b>		
The Dalles	25.3	<b>6.5</b>	--	28.2
John Day	3.8	--	<b>1.0</b>	11.3
McNary	<b>6.3</b>	<b>0.1</b>	--	6.4
Ice Harbor	<b>17.3</b>	<b>1.9</b>	--	19.2
Lower Monumental	<b>21.3</b>	<b>2.3</b>	--	23.6
Little Goose	18.8	<b>4.7</b>	--	23.5

As was the case in John Day Reservoir, the fisheries in Bonneville Dam **tailrace** harvested a disproportional number of large individuals compared to their relative abundance in ODFW index sampling (Figure G-11). Trolled lures were very selective for large northern squawfish. Mean fork length of the dam angling catch was slightly lower than that from lure trolling, but the size distribution of the catch was similar between the two methods. Mean fork length of the sport reward harvest was again the smallest among fisheries.

Fish exceeding 250 mm comprised the vast majority of the catch in each fishery during both 1990 and 1991 (Table G-7). Most of the fish harvested by longlining, dam angling and lure trolling exceeded 400 mm. The percent of sport reward fish exceeding various fork lengths would have been less if lengths of all undersized (<11 inches total length) fish were recorded.

Monthly mean fork length of fish harvested by dam and sport reward anglers fluctuated throughout 1990 and 1991 (Figures G-12 through G-14). During 1990, the size of the catch declined at Bonneville Dam Powerhouse 1 **tailrace** and **forebay**, and at Powerhouse 2 **forebay**. A smaller decline **occured** at The Dalles and John Day dams. At McNary Dam, where catch was the greatest, mean fork length increased slightly through time. During 1991, mean size declined at McNary (where catch was again greatest), Ice Harbor, and Lower Monumental dams. There was little net change in the mean fork length of the sport reward catch during 1991.

#### Baseline Biological Data

The proportions of female northern squawfish in various stages of sexual maturity from May through August were very similar among reservoirs (Table G-8). The low percentage of undeveloped and high percentage of developing females in May indicate that the vast majority of females underwent **gonadal** maturation and presumably reproduced. During 1990, we captured appreciable numbers of ripe females during June and July, after which the proportion of

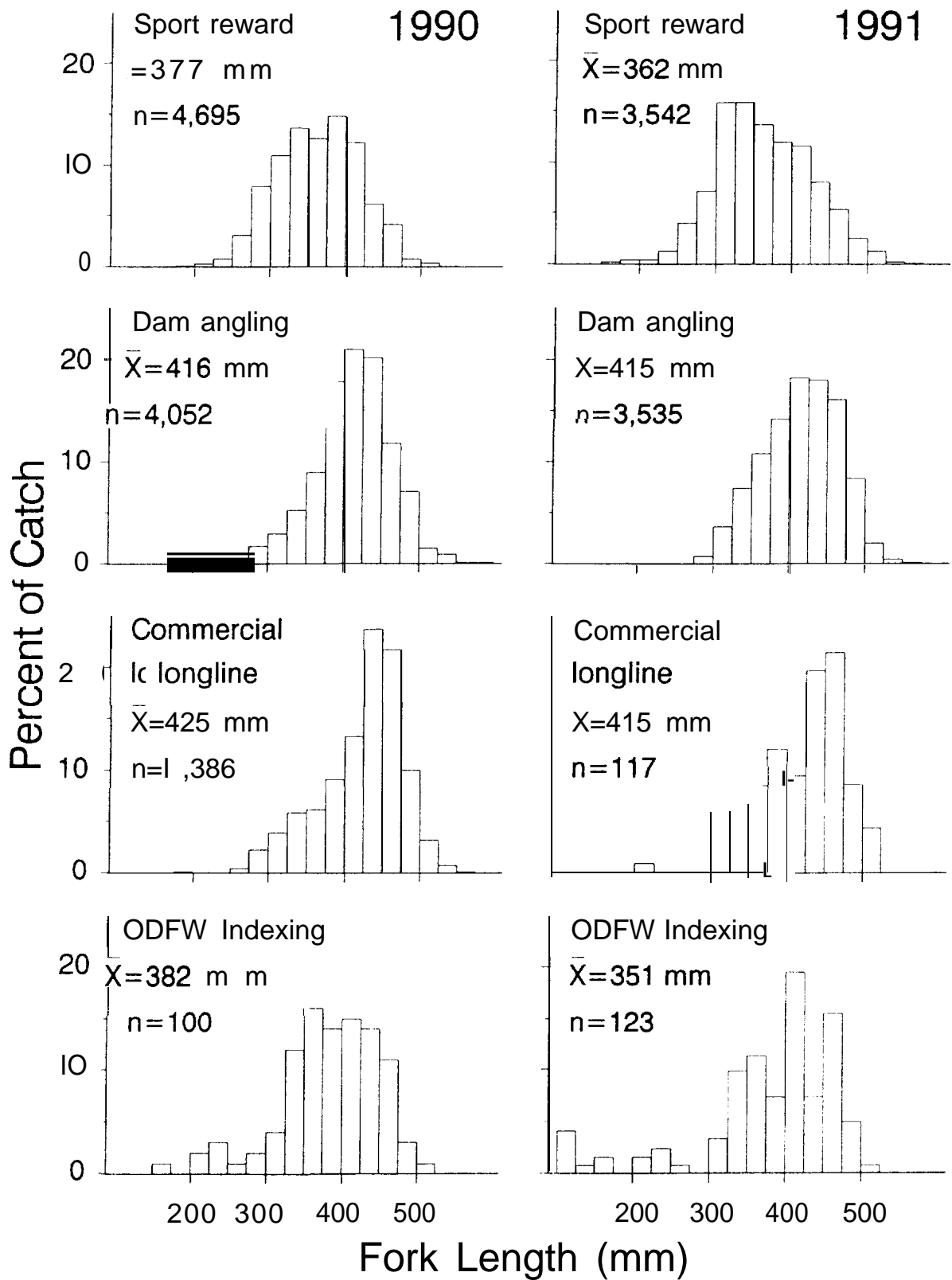

Figure G-10. Size composition of the northern squawfish catch in John Day Reservoir in each fishery and in the ODFW indexing sample during 1990 and 1991.

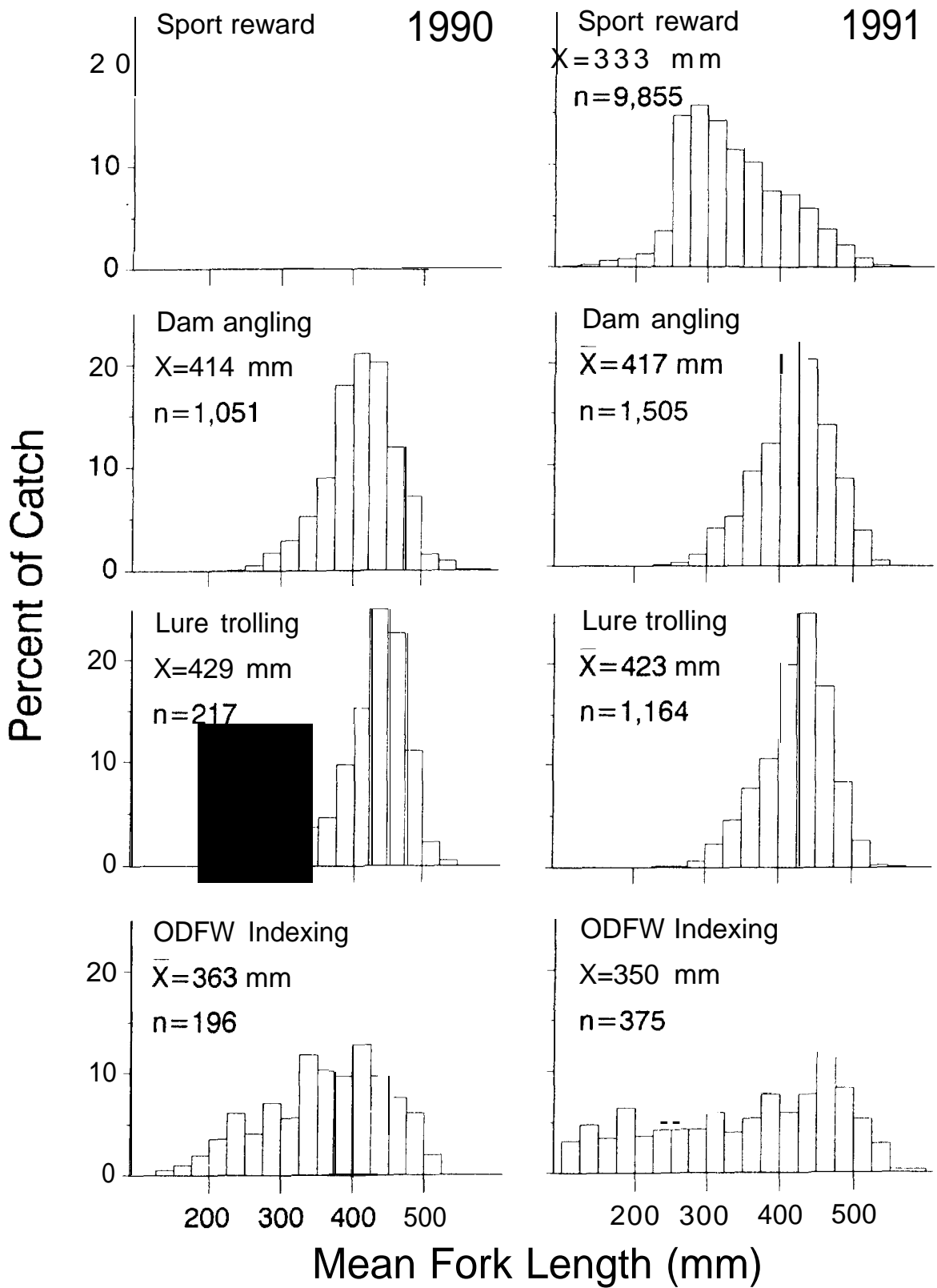

Figure G-11. Size composition of the northern squawfish catch in Bonneville Dam tailrace in each fishery and in the ODFW indexing sample during 1990 and 1991.

Table G-7. Percent of northern squawfish exceeding various fork lengths in each fishery and in ODFW indexing samples in John Day Reservoir and Bonneville Dam **tailrace** during 1990 and 1991.

Area, fishery	Percent greater than							
	250 mm		300 mm		350 mm		400 mm	
	1990	1991	1990	1991	1990	1991	1990	1991
<b>John Day Reservoir</b>								
Longlining	99.9	99.1	97.3	95.7	87.7	83.8	72.7	63.3
Dam angling	99.9	99.9	99.5	99.3	89.3	88.3	60.9	63.3
Sport reward	98.8	97.7	87.8	86.5	63.3	54.9	35.9	29.1
ODFW indexing	93.0	80.5	90.0	79.7	74.0	66.7	56.0	48.0
<b>Bonneville Dam tailrace</b>								
Lure trolling	99.6	99.9	98.7	99.2	90.4	92.4	73.8	74.1
Dam angling	99.9	99.9	97.7	98.5	89.6	90.0	62.8	68.6
Sport reward	--	93.5	--	63.2	--	37.5	--	19.9
ODFW indexing	86.7	74.1	<b>75.5</b>	65.6	<b>58.2</b>	55.7	<b>38.3</b>	42.7

ripe females declined to less than 5%. Consequently, the proportion of spent females increased dramatically from 0% in June to 60 to 92% in August. Spawning may have occurred later during 1991; we collected fewer ripe females in June, and more in August than during 1990 (Table G-8).

Mean estimated fecundity for 129 female northern squawfish collected from the lower Columbia River during 1990 was 20,639 developed eggs. Estimates ranged from 8,520 (fork length = 373 mm) to 42,092 (fork length = 449 mm). The mean length of fish used in fecundity estimates was 416 mm (range 234-510 mm). Mean fecundity estimates indicated similar numbers of developed eggs per female among reservoirs sampled during 1990 (Table G-9). Mean relative fecundity for Bonneville Dam **tailrace** and Bonneville Reservoir was 27.5 and 25.4 eggs per gram of body weight respectively. The number of ripe ovary samples collected during 1990 was extremely low except for these two areas (Table G-9).

Estimated mean fecundity for 474 female northern squawfish collected from the lower Columbia and Snake rivers during 1991 was 29,157 developed eggs. Estimates ranged from 3,848 (fork length = 310 mm) to 88,282 (fork length = 535 mm). The mean length of fish used in fecundity estimates was 414 mm (range 280-552 mm). Mean relative fecundity ranged from 27.3 (McNary Reservoir) to 37.3 (Bonneville Dam **tailrace**) eggs per gram of body weight. Variability in fecundity among reservoirs was higher in 1991 than 1990 (Table G-9).

Mean fecundity was higher in 1991 than 1990 for fish from Bonneville Reservoir and Bonneville Dam **tailrace** (the only areas where sufficient samples were collected each year). Two-way analysis of variance (SAS Institute Inc. 1987) revealed that mean fork length of fish from these two areas used in fecundity analysis was longer ( $P < 0.05$ ) in 1991 (mean = 423 mm) than in 1990

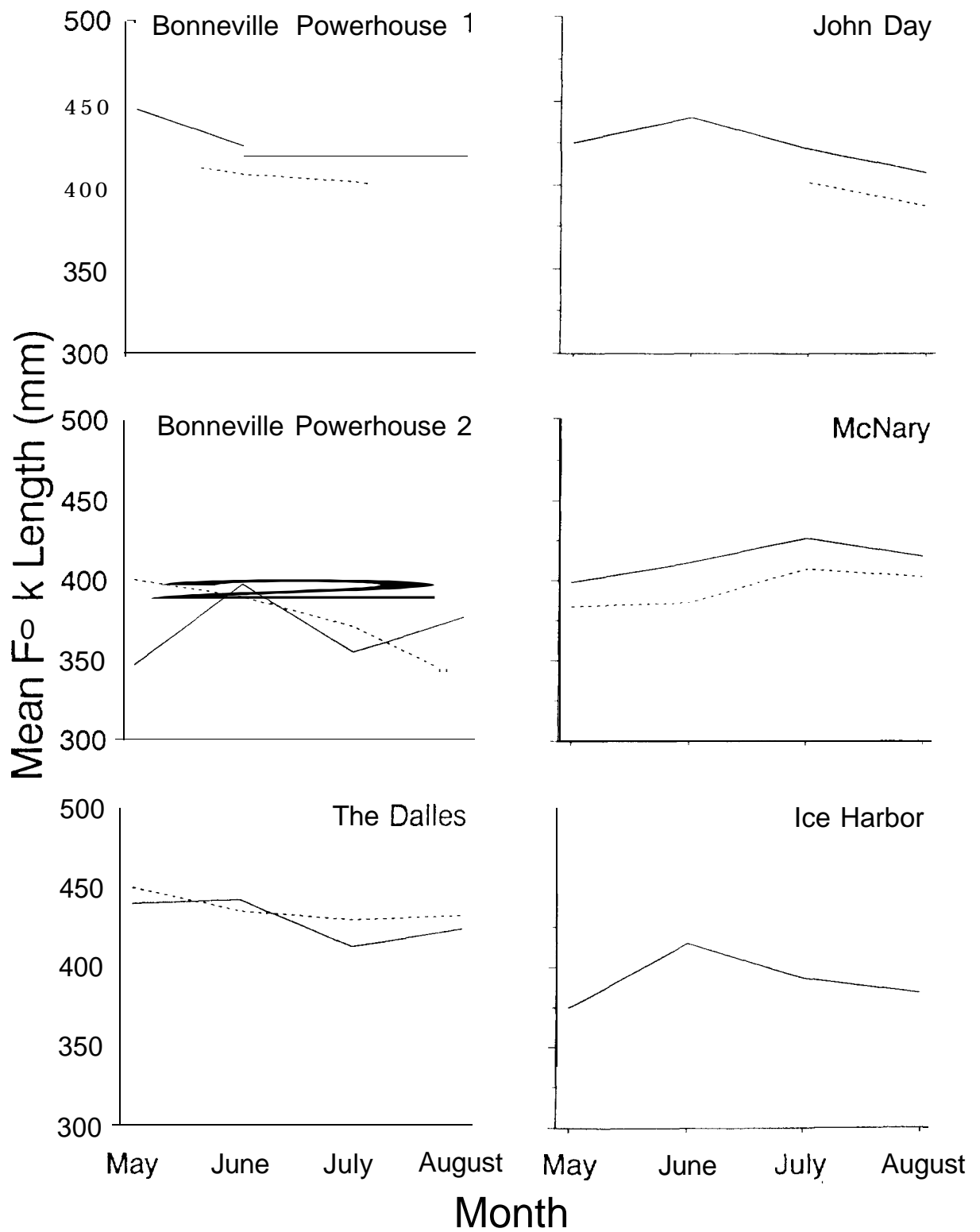

Figure G-12. Monthly mean fork length of northern squawfish harvested by dam angling at lower Columbia River dams and at Ice Harbor Dam during 1990. Solid lines represent tailrace areas and broken lines represent forebay areas.

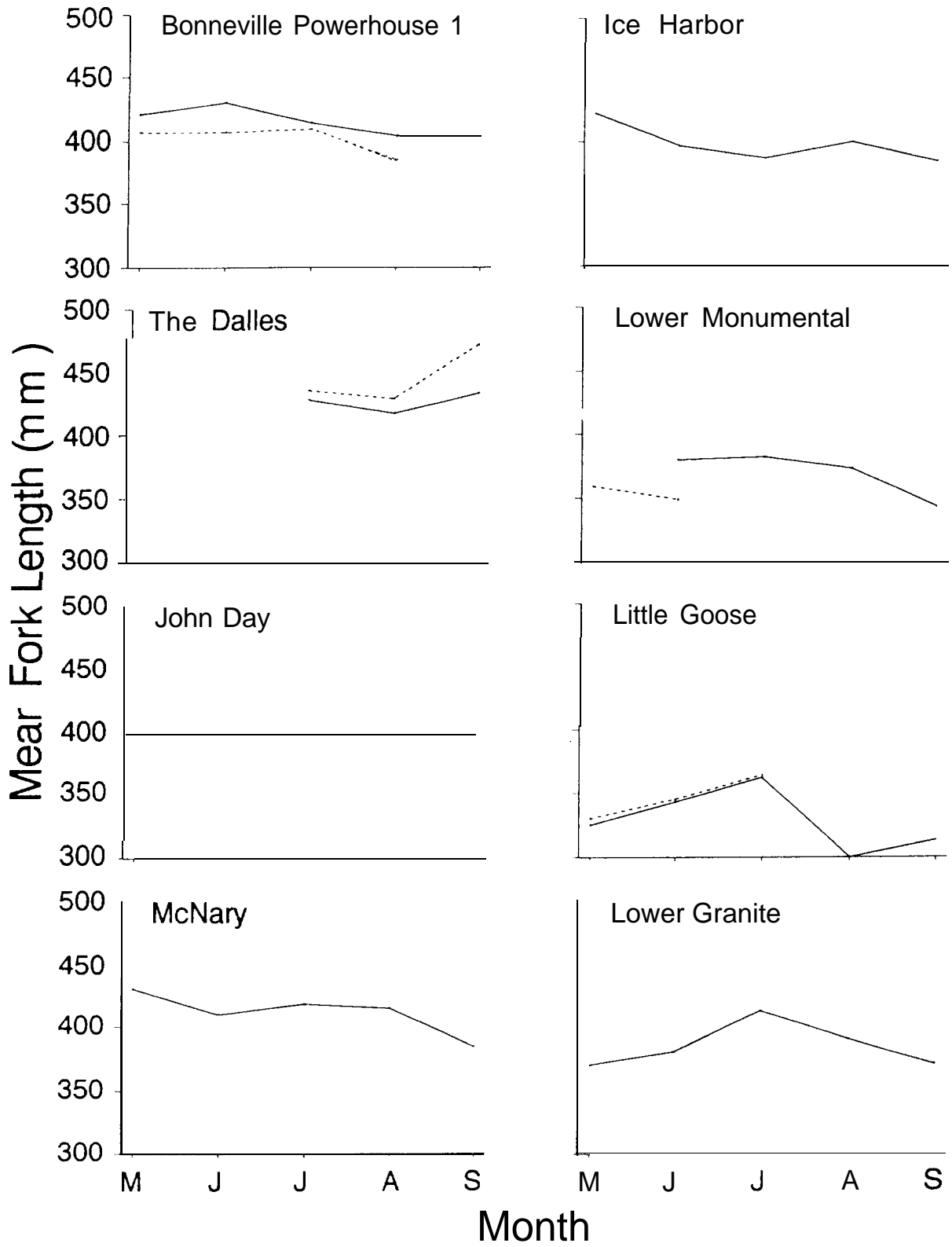

Figure G-13. Monthly mean fork length of northern squawfish harvested by dam angling at lower Columbia and Snake River dams during 1991. Solid lines represent tailrace areas and broken lines represent forebay areas.

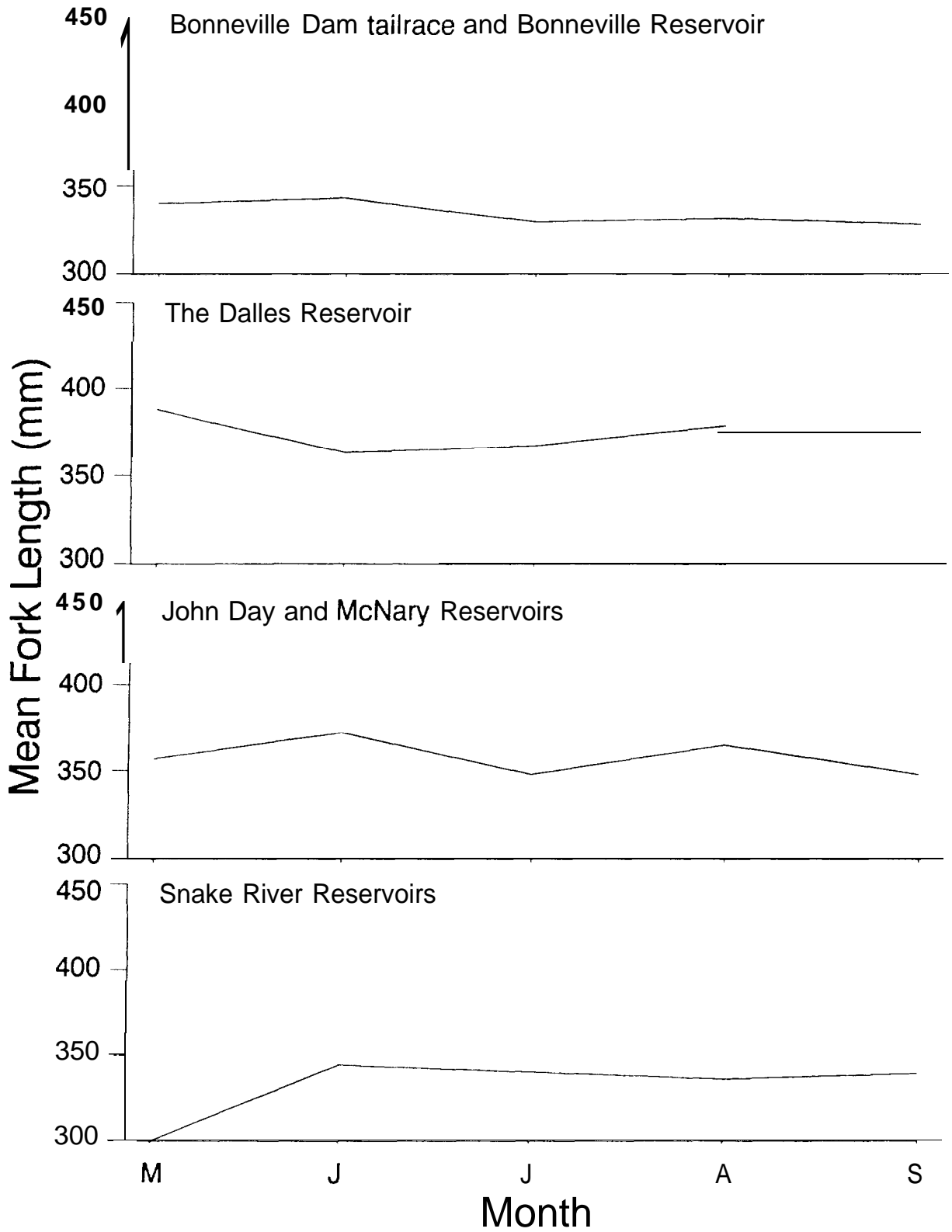

Figure G-14. Monthly mean fork length of northern squawfish harvested during the sport reward fishery in the lower Columbia and Snake rivers during 1991.

Table G-8. Percent of female northern squawfish in various stages of maturity (gonadal development) by month in lower Columbia and Snake River reservoirs and Bonneville Dam tailrace during 1990 and 1991.

Reservoir, stage	May		June		July		August	
	1990	1991	1990	1991	1990	1991	1990	1991
<b>Bonneville Dam tailrace</b>								
Undeveloped	0.0	1.0	6.6	0.0	0.0	1.3	2.1	0.0
Developing	80.0	84.0	46.7	97.9	31.3	79.6	1.0	2.6
Ripe	20.0	15.0	46.7	2.1	50.0	4.7	4.7	25.6
Spent	0.0	0.0	0.0	0.0	18.7	14.4	92.2	71.8
<b>Bonneville</b>								
Undeveloped	1.3	6.5	0.7	0.0	1.1	0.5	4.2	7.1
Developing	98.7	93.6	85.3	100.0	16.7	40.1	32.4	0.0
Ripe	0.0	0.0	14.0	0.0	34.2	17.0	3.4	0.0
Spent	0.0	0.0	0.0	0.0	48.0	42.5	60.0	92.9
<b>The Dalles</b>								
Undeveloped	1.3	0.0	3.3	0.0	3.1	0.6	2.2	0.0
Developing	98.7	85.0	64.8	90.3	79.4	58.1	9.9	0.0
Ripe	0.0	15.0	31.9	9.7	1.2	14.9	1.1	3.8
Spent	0.0	0.0	0.0	0.0	16.3	26.4	86.8	96.2
<b>John Day</b>								
Undeveloped	6.2	0.0	0.0	0.0	0.9	0.0	2.9	0.0
Developing	93.8	100.0	90.6	86.0	52.0	48.3	2.3	10.0
Ripe	0.0	0.0	9.4	14.0	11.9	19.7	4.8	24.0
Spent	0.0	0.0	0.0	0.0	35.2	32.0	90.0	75.0
<b>McNary</b>								
Undeveloped	0.0	0.0	1.3	0.0	3.6	0.0	9.2	0.0
Developing	100.0	100.0	53.1	80.4	43.4	25.0	0.5	0.0
Ripe	0.0	0.0	45.6	19.6	7.2	67.9	4.4	0.0
Spent	0.0	0.0	0.0	0.0	45.8	7.1	85.9	100.0
<b>Ice Harbor</b>								
Undeveloped	--	0.0	--	7.4	--	12.8	--	3.1
Developing	--	100.0	--	84.8	--	47.1	--	0.0
Ripe	--	0.0	--	6.2	--	26.5	--	0.0
Spent	--	0.0	--	1.6	--	13.7	--	96.9
<b>Lower Monumental</b>								
Undeveloped	--	9.2	--	3.5	--	--	--	0.0
Developing	--	90.8	--	84.2	--	2.2	--	0.0
Ripe	--	0.0	--	10.5	--	22.2	--	5.6
Spent	--	0.0	--	1.8	--	48.9	--	94.4



Table G-8. Continued.

Reservoir, stage	May		June		July		August	
	1990	1991	1990	1991	1990	1991	1990	1991
Little Goose Undeveloped	--	--	--	2.7	--	0.0	--	0.0
Developing	--	0.0	11	87.1	--	26.4	--	0.0
Ripe	--	0.0	--	10.2	--	27.9	--	4.0
Spent	--	0.0	--	0.0	--	45.7	--	96.0

Table G-9. Mean fecundity estimates for female northern squawfish collected during 1990 and 1991. *N* = sample size.

Reservoir	1990			1991		
	<i>N</i>	Developed eggs	Undeveloped eggs	<i>N</i>	Developed eggs	Undeveloped eggs
Bonneville Dam tailrace	49	20,527	4,864	74	36,359	13,673
Bonneville	55	20,236	5,715	46	35,821	15,295
The Dalles	5	24,217	6,544	90	29,068	9,510
John Day	1	20,926	4,812	83	30,460	15,797
McNary	19	21,140	6,302	28	22,030	7,036
Ice Harbor	--	--	--	32	25,790	9,852
Lower Monumental	--	--	--	16	20,243	11,029
Little Goose	--	--	--	53	22,571	7,284
Lower Granite	--	--	--	52	26,452	9,630

(mean = 398 mm). Sampling year affected the mean fork length of fish from each area similarly ( $P > 0.05$ ).

Plots of the  $\log_{10}$  transformation of fecundity versus the  $\log_{10}$  transformations of fork length and body weight were highly variable. The number of developed eggs was positively but not highly correlated ( $r = 0.19$  to  $0.75$ ) with fork length and body weight for female northern squawfish in all areas evaluated during 1990 and 1991 (Figures G-15 through G-20).

We aged northern squawfish to 15 years old in 1990 and 16 years old in 1991. Age composition was similar among reservoirs, except for an apparently large number of two-year-old fish present in McNary Reservoir in 1990 (Figures G-21 and G-22). Mean backcalculated fork lengths at age were also similar among reservoirs except for mean length at age 1 (Figures G-23 and G-24). Von Bertalanffy growth parameters were variable but similar among reservoirs (see Appendix G). Weight versus fork length relationships were similar among reservoirs; however, the slopes of the weight-length equations for fish in

Bonneville and John Day reservoirs were relatively low (Figures G-25 and G-26).

Northern squawfish appeared fully vulnerable to our indexing gear (electrofishing, bottom gillnets, and surface gillnets combined) by age 7 (Figures A-27 and A-28). Annual mortality rates were similar among reservoirs except for John Day and Bonneville reservoirs, where annual mortality was lowest, and Lower Monumental Reservoir, where annual mortality was highest.

#### Lure Trolling

We caught a total of 1,168 northern squawfish during 864 lure-hours in 1991. Catch rates increased from May through July and then declined (Table G-10). Catch rate varied among lure types (Table G-11). Our total incidental catch for the entire season consisted of one smallmouth bass and one steelhead.

We determined the sex of 933 northern squawfish. Of this total only 30 were males (Table G-12). The percentage of males was highest in the late season; however, the number of fish examined was extremely small.

Mean fork length was highest in June (Table G-10), and decreased throughout the remainder of the season. Mean fork length varied little with lure type (Table G-11). Late season mean fork lengths were consistently lower and varied more among lure types than those in the early season.

We caught most northern squawfish in depths of 10-19 ft (Table G-13). CPUE was highest from 20 to 24 feet, but effort was low.

#### DISCUSSION

Results from index sampling indicate that although predation on juvenile salmonids by northern squawfish occurs throughout the lower Columbia and Snake rivers, the problem is most prevalent in John Day Reservoir. Other than during the summer of 1990, our area-specific predation information indicates that predation is greatest outside of boat restricted zones. This agrees with findings by Rieman et al. (1991) who reported that most predation in John Day Reservoir occurred outside the boat restricted zones. Because of sample size constraints, our reservoir-wide predation indices may be more reliable than those that are area-specific.

Abundance and consumption indexing results for each reservoir are based on sampling for one year only; therefore, they may be extremely vulnerable to bias. Consumption estimates may especially be biased if sampling occurs during the peak of juvenile salmonid outmigration in some reservoirs but not others. Furthermore, the abundance index relies on the assumption that catchability of northern squawfish is similar among reservoirs. This may or may not be true. However, 1991 results indicate that indexing catch rates and catch rates by dam anglers and sport reward anglers varied similarly among areas and reservoirs.

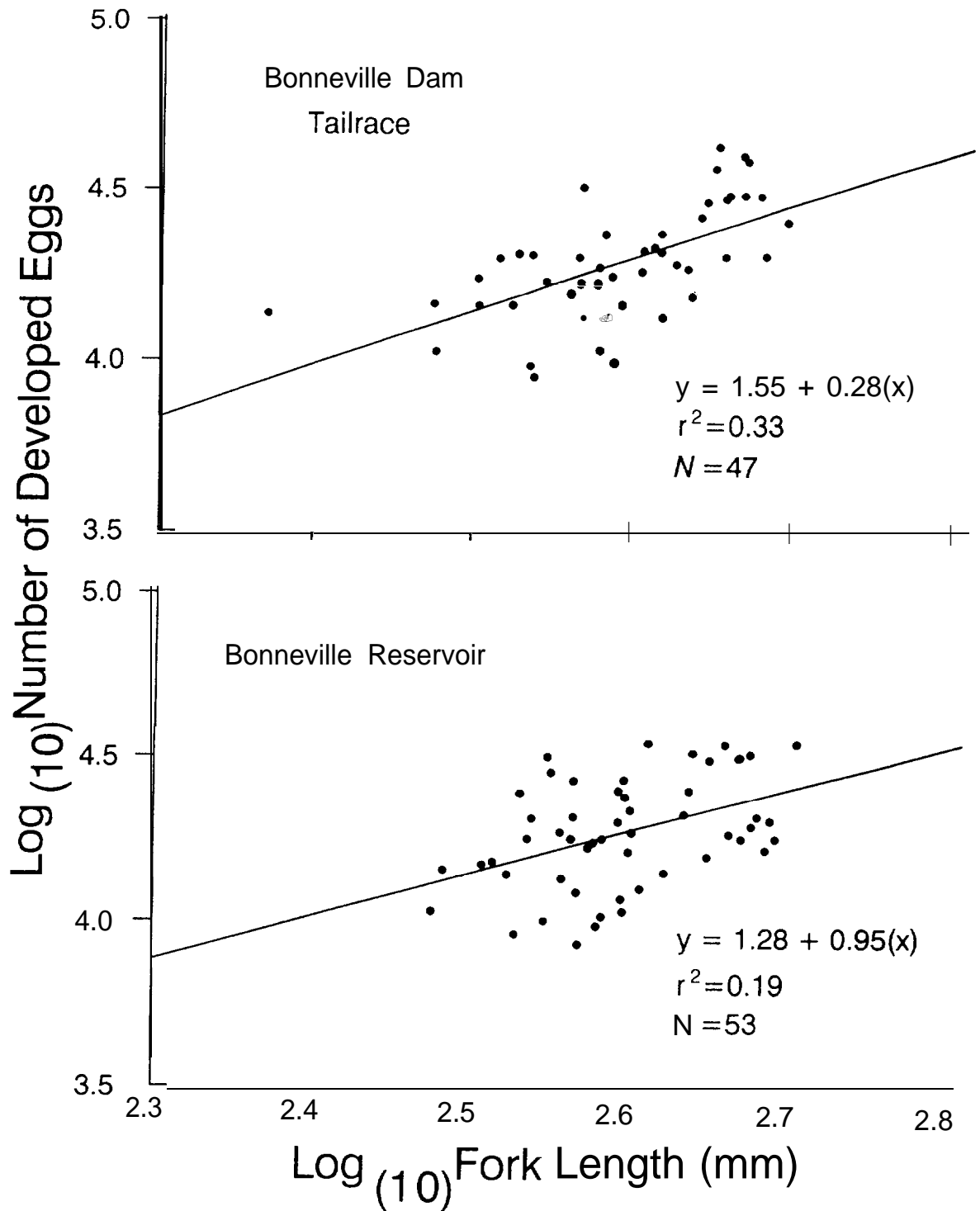

Figure G-15. Relationship of fecundity to fork length for female northern squawfish collected during 1990 in Bonneville Dam tailrace and Bonneville Reservoir.

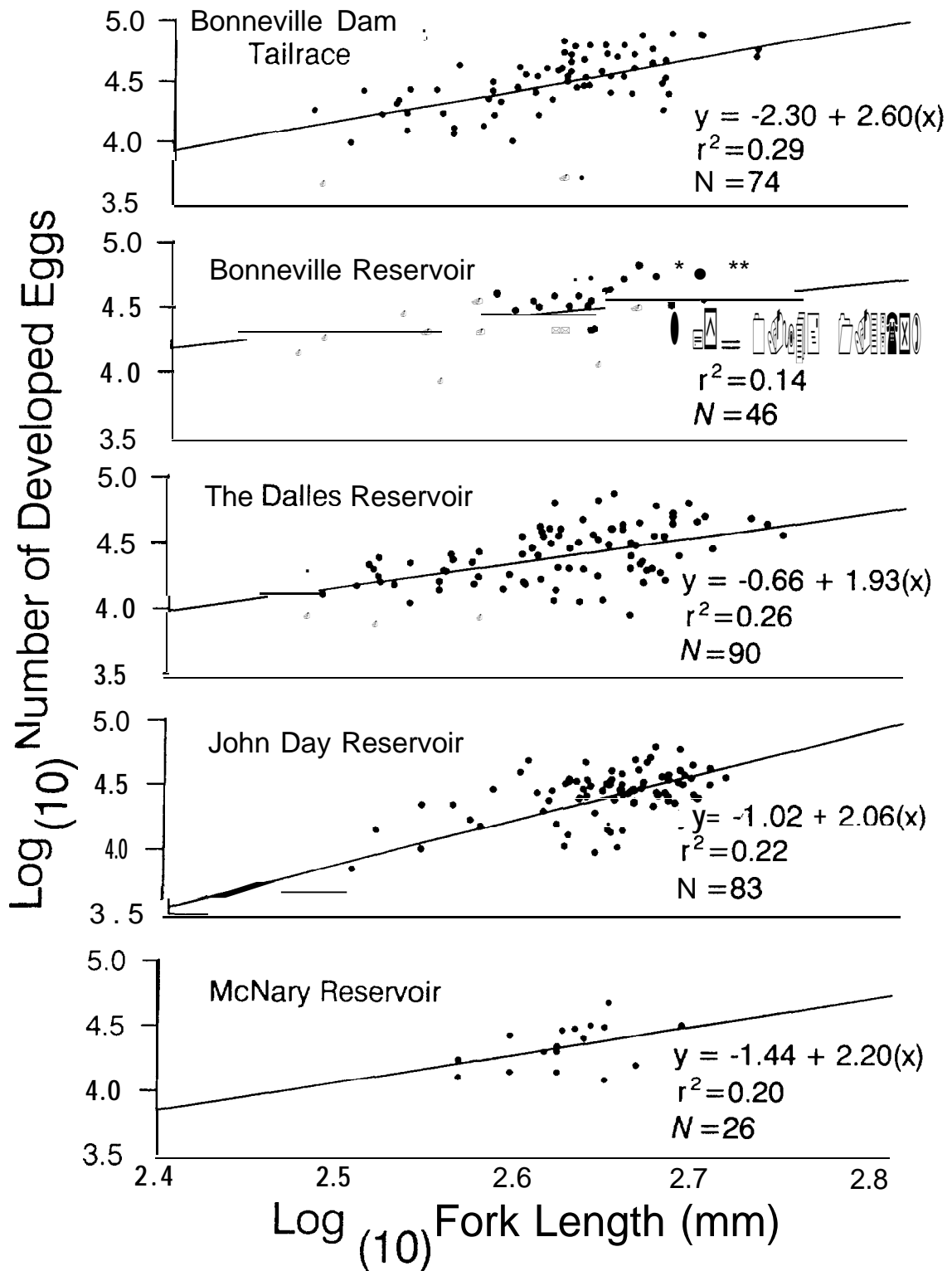

Figure G-16. Relationship of fecundity to fork length for female northern squawfish collected during 1991 in Columbia River reservoirs.

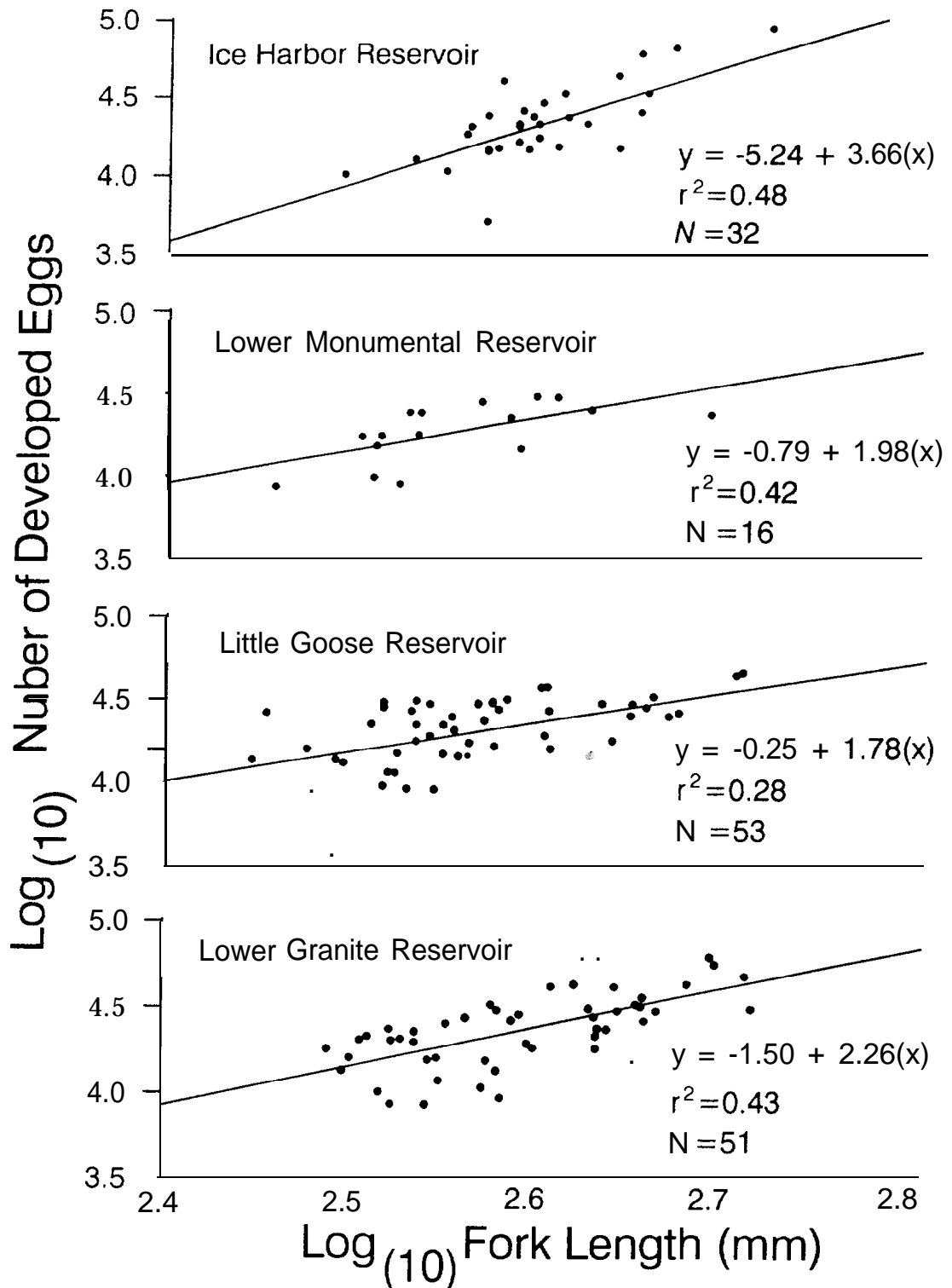

Figure G-17. Relationship of fecundity to fork length for female northern squawfish collected during 1991 in Snake River reservoirs.

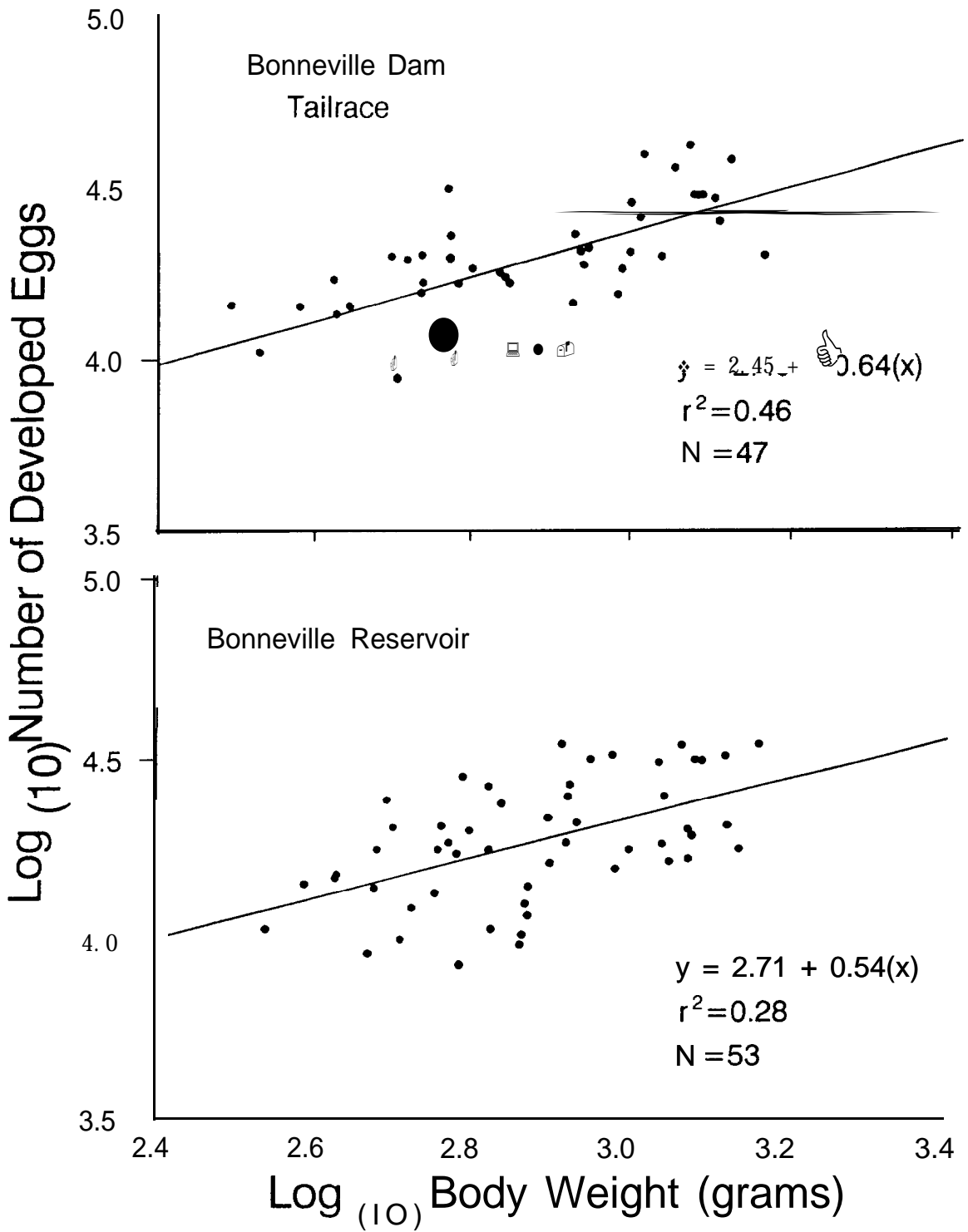

Figure G-18. Relationship of fecundity to weight for female northern squawfish collected during 1990 in Bonneville Dam tailrace and Bonneville Reservoir.

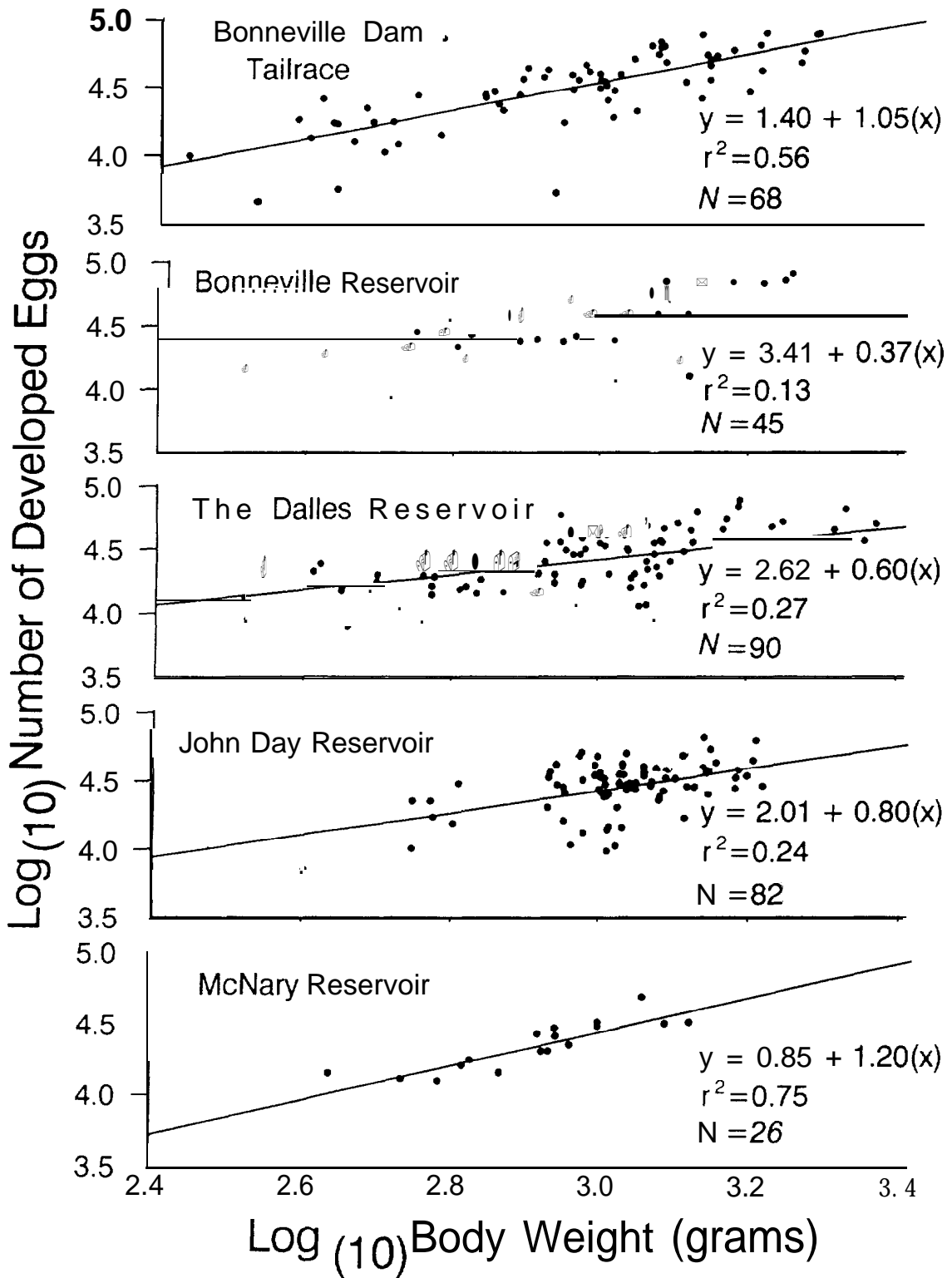

Figure G-19. Relationship of fecundity to weight for female northern squawfish collected during 1991 in Columbia River reservoirs.

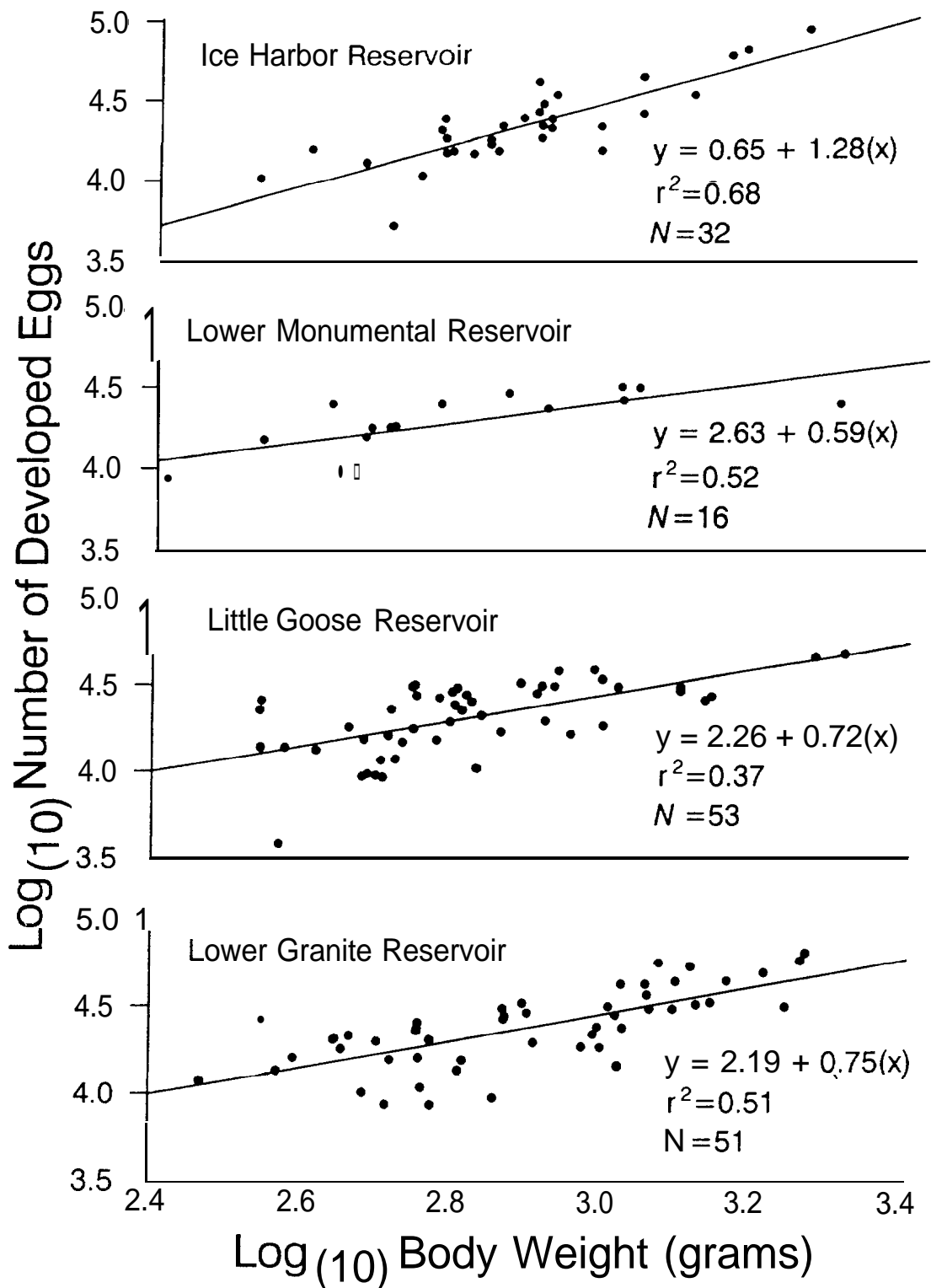

Figure G-20. Relationship of fecundity to weight for female northern squawfish collected during 1991 in Snake River reservoirs.



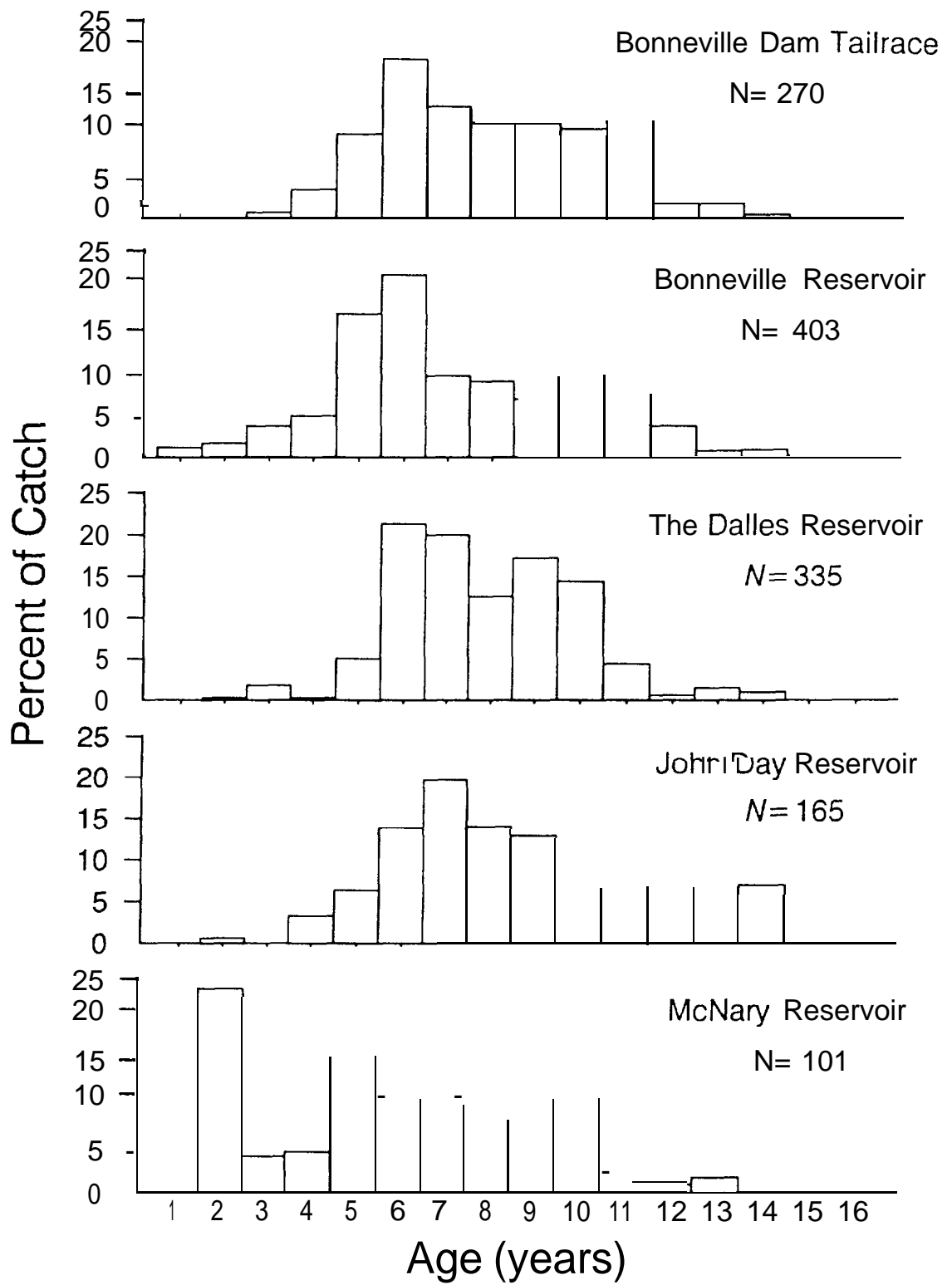

Figure G-21. Age composition of northern squawfish in Columbia River reservoirs during 1990.

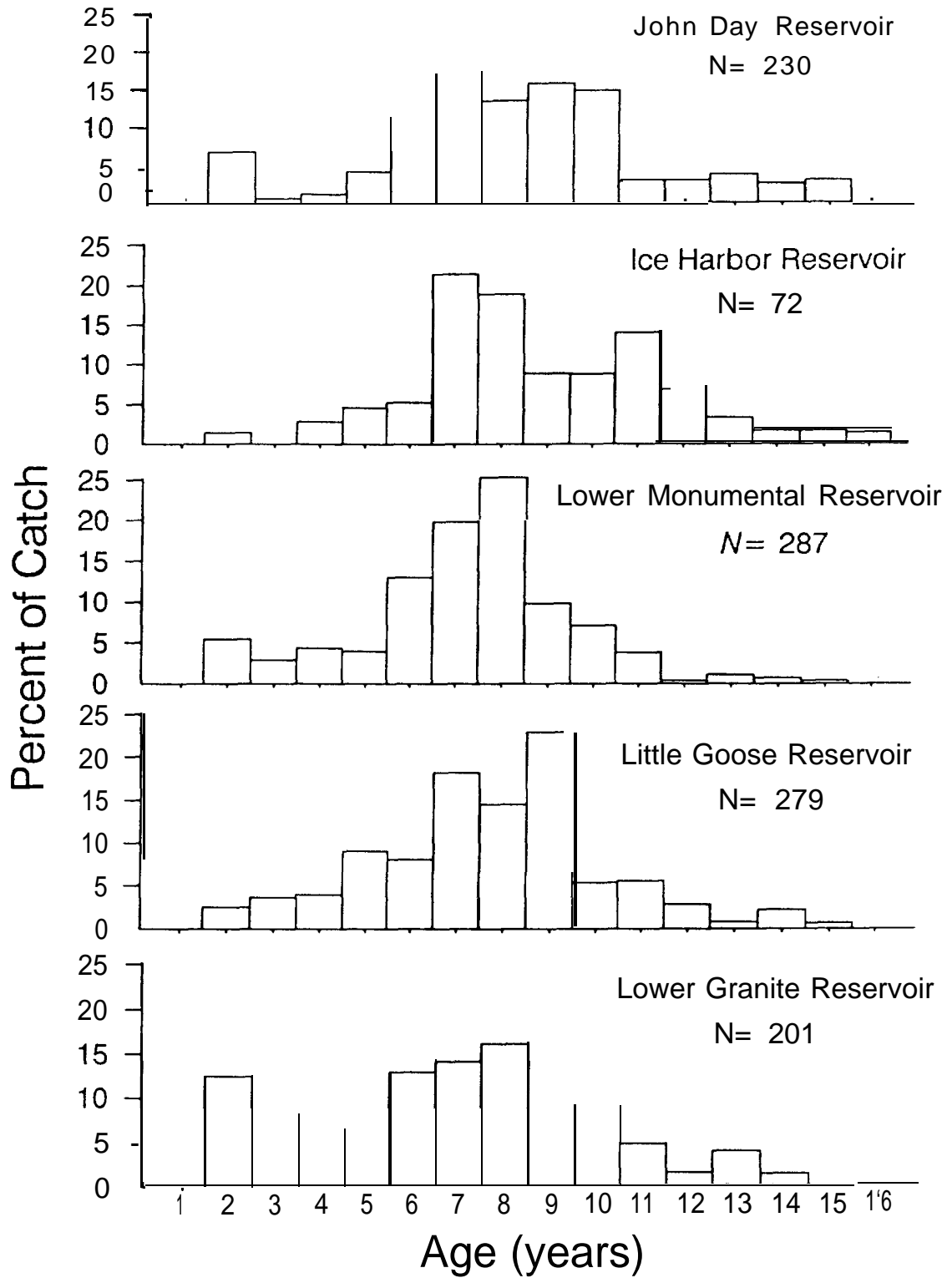

Figure G-22. Age composition of northern squawfish in John Day Reservoir and Snake River reservoirs during 1991.

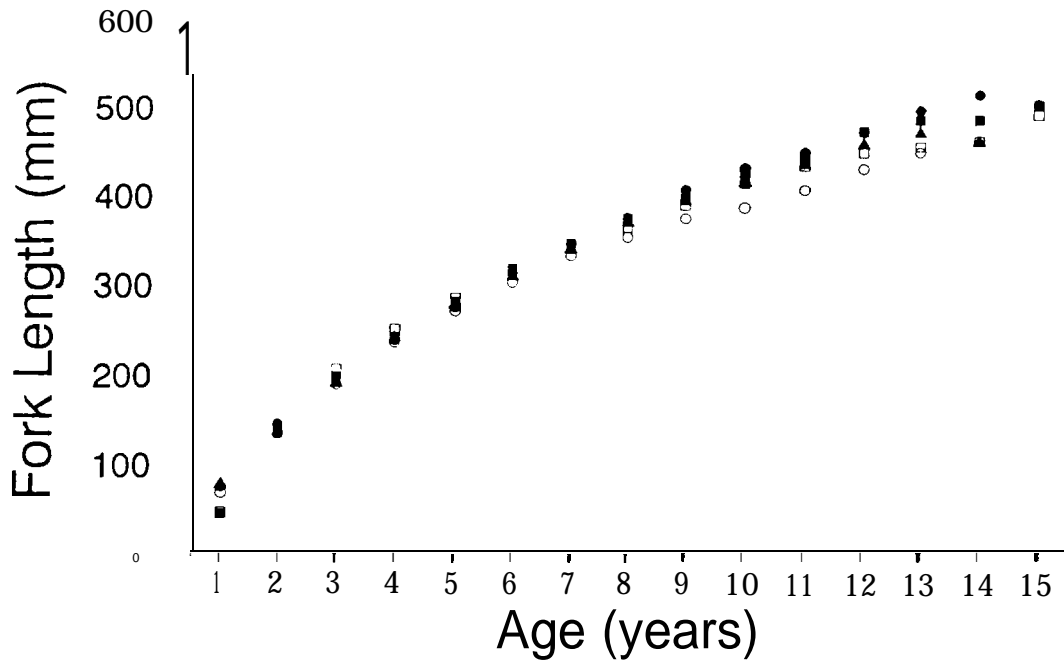

Figure G-23. Backcalculated fork lengths at age for northern squawfish in Columbia River reservoirs (● = Bonneville Dam tailrace, ■ = Bonneville Reservoir, ○ = The Dalles Reservoir, ○ = John Day Reservoir, and □ = McNary Reservoir).

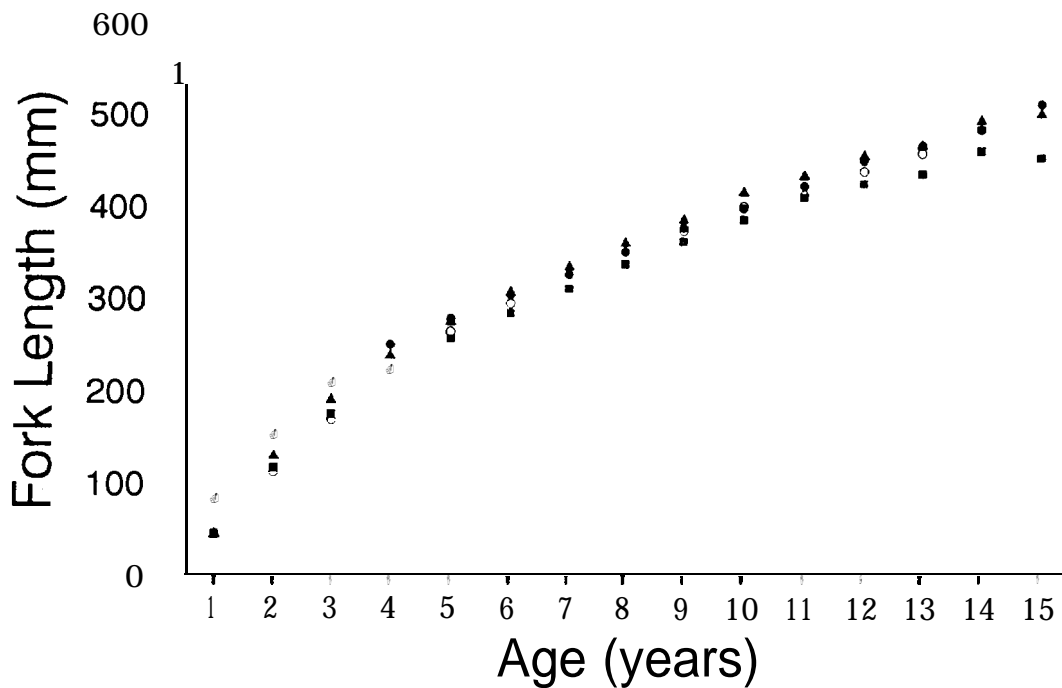

Figure G-24. Backcalculated fork lengths at age for northern squawfish in Snake River reservoirs (● = Ice Harbor Reservoir, ■ = Lower Monumental Reservoir, ▲ = Little Goose Reservoir, and ○ = Lower Granite Reservoir).

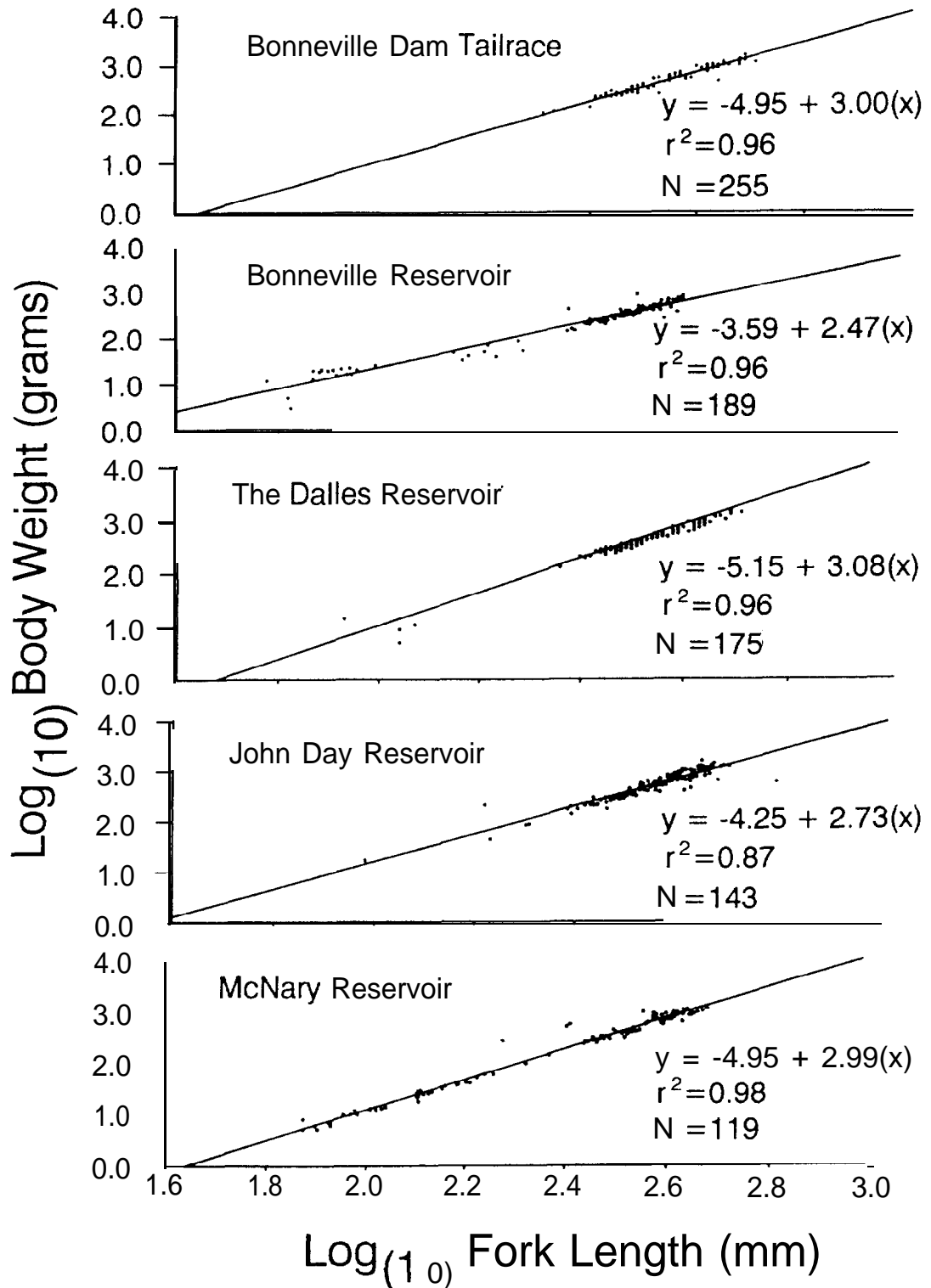

Figure G-25. Relationship of weight to fork length for northern squawfish collected in Columbia River reservoirs during 1990.

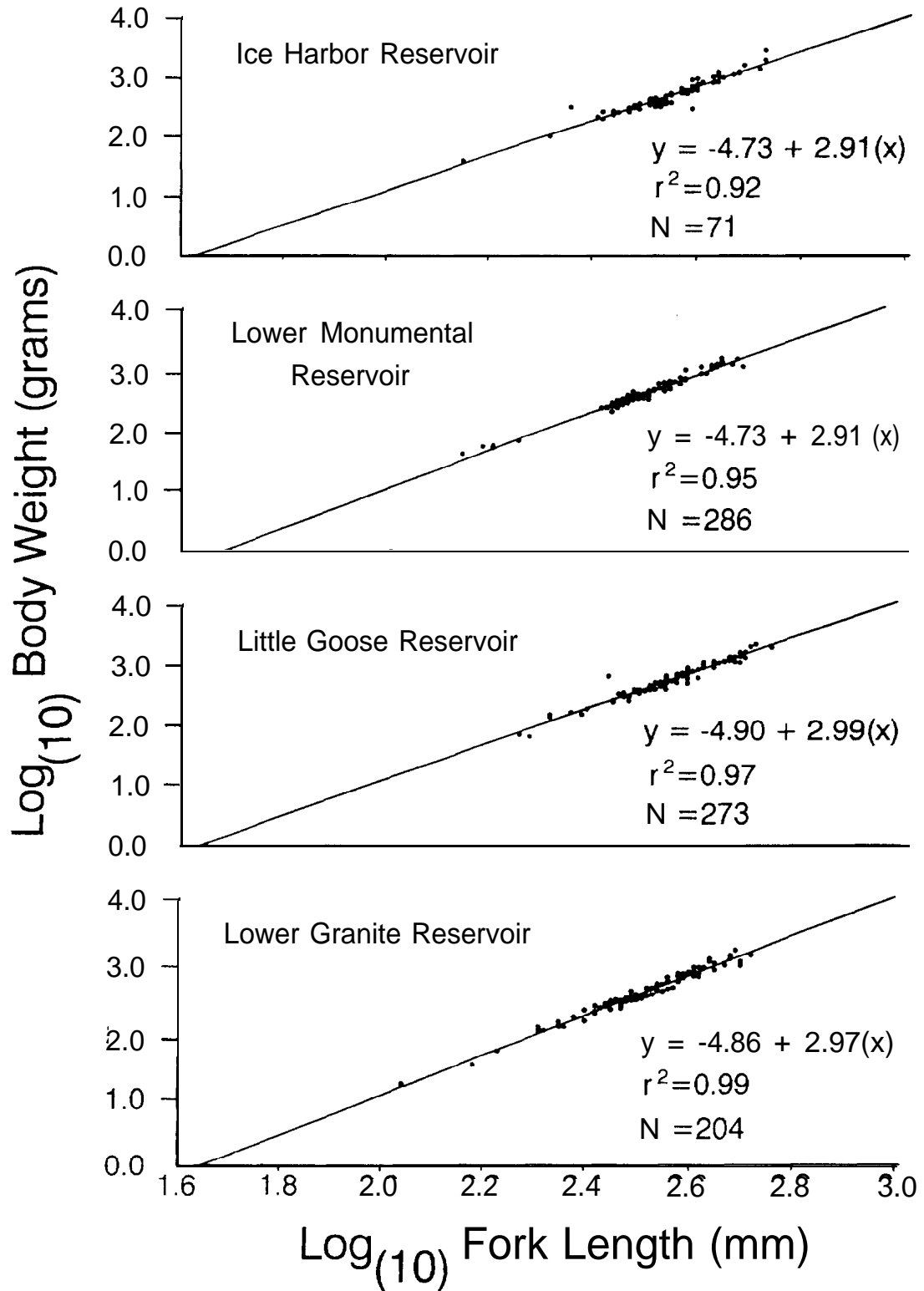

Figure G-26. Relationship of weight to fork length for northern squawfish collected in Snake River reservoirs during 1991.

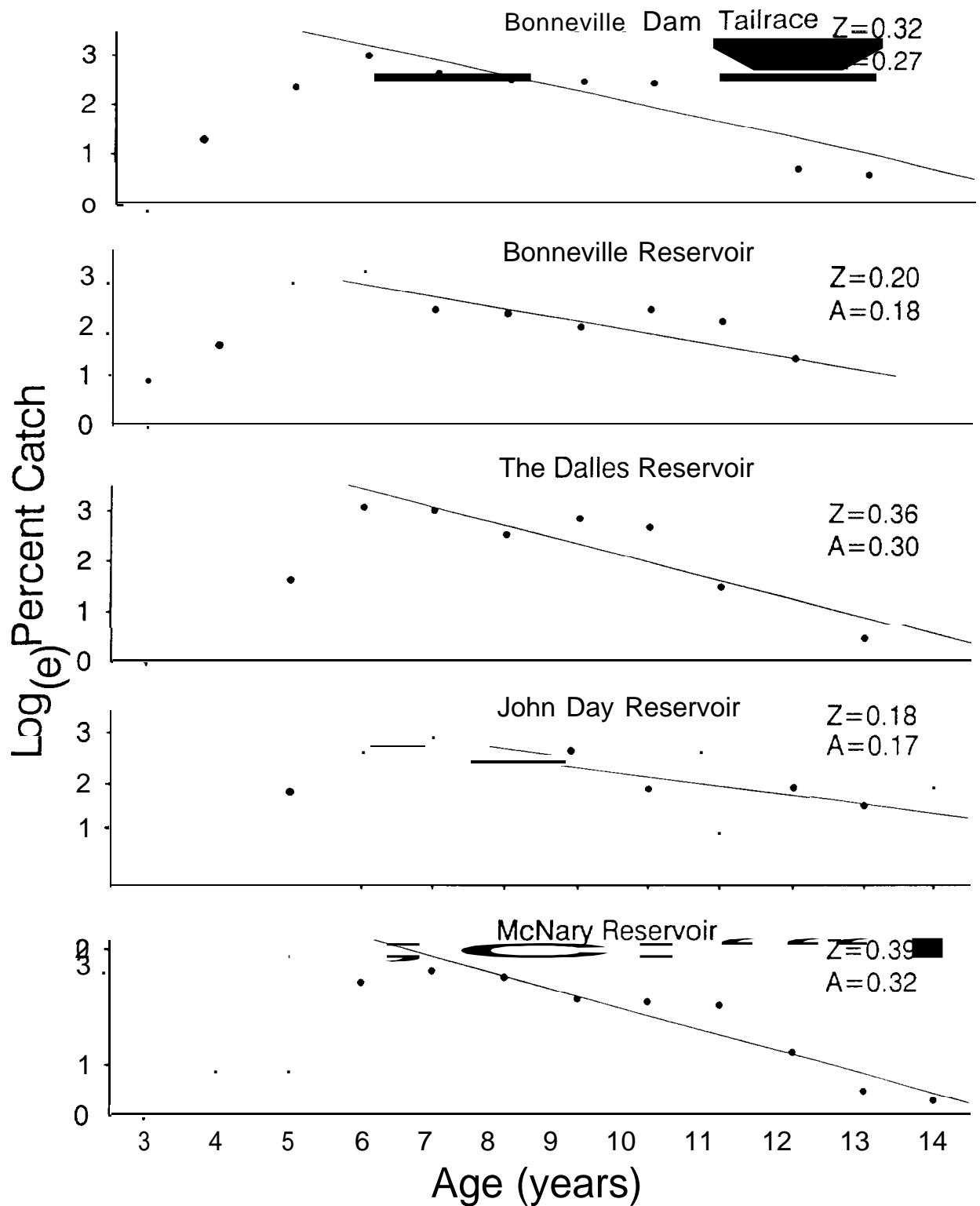

Figure G-27. Catch curves for northern squawfish collected in bottom gillnets in Columbia River reservoirs during 1990.  $Z$  = total instantaneous mortality,  $A$  = annual mortality rate.

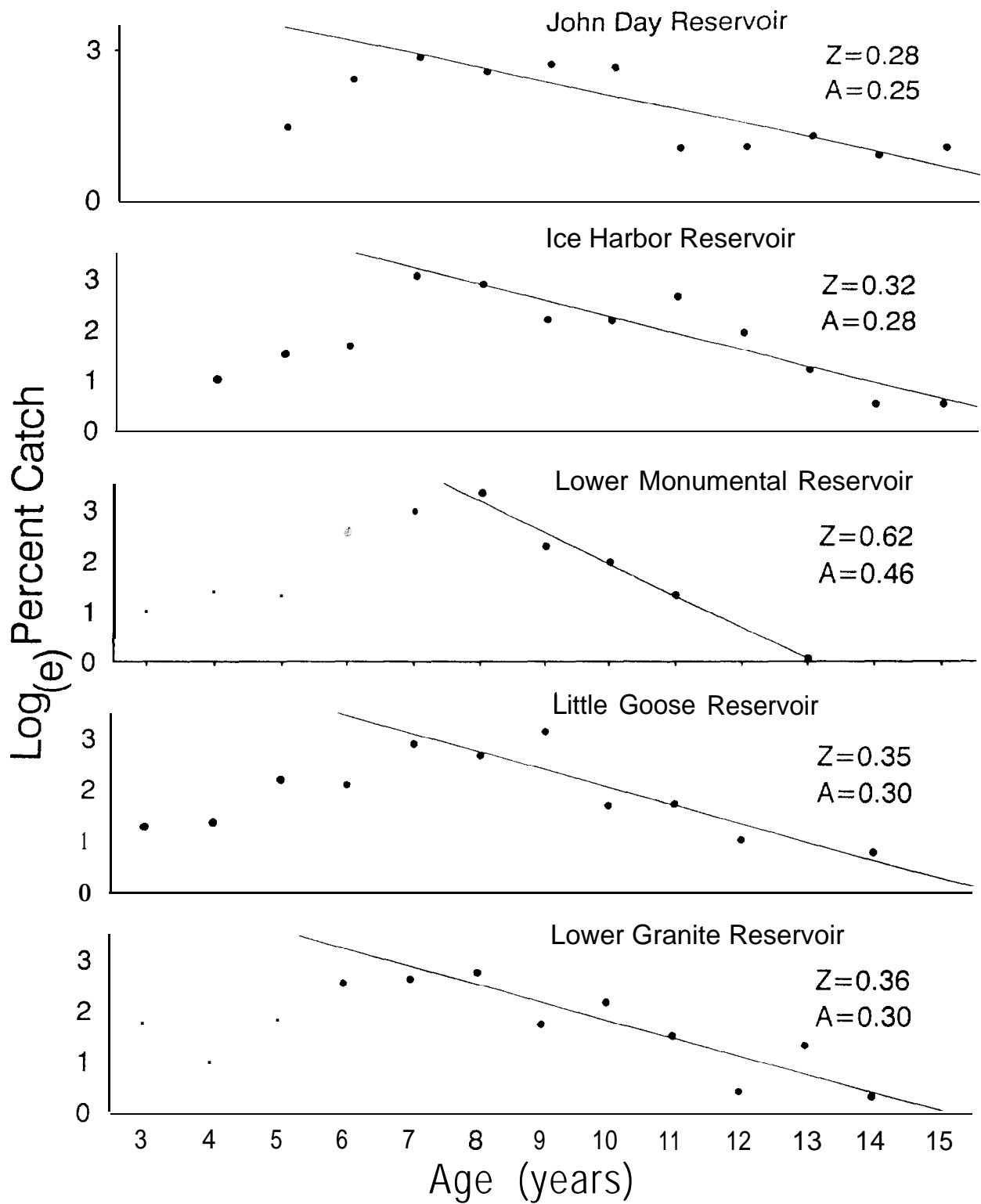

Figure G-28. Catch curves for northern squawfish collected in bottom gillnets in John Day Reservoir and Snake River reservoirs during 1991.  $Z$  = total instantaneous mortality,  $A$  = annual mortality rate.

Table G-10. Monthly totals of effort, northern squawfish catch, catch per lure-hour, and mean fork length of northern squawfish caught by lure trolling during 1991.

Month	Effort (lure-hours)	Catch	Catch per lure hour	Mean fork length (mm)
May	115	62	0.54	430
June	161	239	1.48	434
July	263	686	2.61	425
August	239	151	0.63	403
September	86	30	0.35	374

Table G-11. Catch, catch per hour, and mean fork length (mm) of northern squawfish caught in the 1991 lure trolling study by lure type and season.

	Early (13 May-19 July)			Late (22 July-23 September)		
	Catch	Catch per hour	Mean fork length	Catch	Catch per hour	Mean fork length
Tennessee Shad Speed Trap	217	2.61	427	61	0.73	420
Rainbow Trout Kwikfish	173	2.11	425	14	0.26	402
Silver Shad Kwikfish	93	1.37	429	35	0.52	405
Rainbow Trout Hi-catch	159	2.30	427	78	0.93	402
Silver Blue Speed Trap	160	2.42	430	69	0.87	411
Chrome Hot Shot	83	1.41	426	26	0.38	404

The size range of northern squawfish collected in ODFW index samples was wider than that in any fishery. This confirms the importance of index sampling for collecting representative abundance and biological data.

During 1992 we will conduct index sampling in the Columbia River downstream from Bonneville Dam and in John Day Reservoir. Because of its length, the Columbia River downstream from Bonneville Dam will be partitioned into four sampling zones. There will be three zones of approximately equal length between Jones Beach (river mile 45) and Multnomah Falls (river mile 135). These zones will be further partitioned into lower, middle, and upper sampling areas. The fourth zone will be Bonneville Dam tailrace, where we have sampled



Table G-12. Number of northern squawfish caught in the 1991 lure trolling study by sex and season.

Sex	Early (13 May - 19 July)	Late (22 July - 23 September)
Female	864	39
Male	18	12
Undetermined	3	232

Table G-13. Northern squawfish catch in the 1991 lure trolling study by depth interval (ft).

Depth	Catch	Effort (lure-hours)	Catch per lure hour
0-4	<b>149</b>	19::	0.50
5-9			0.75
10-14	367	253	1.45
15-19	405	160	2.53
20-24	<b>25</b>	<b>14</b>	2.87
25-29	<b>36</b>	<b>163</b>	0.36
30-34			0.22

during 1990 and 1991. As in previous years, results for each zone will be compared to results from John Day Reservoir.

It appears that a 10-20% exploitation rate of northern squawfish is feasible. Our estimates of system-wide exploitation during 1991 varied only from 10.0 to 14.8%, depending on whether we used one or two years data, and on assumptions regarding the degree of mixing of fish marked and released at dams. Using data from one year only may result in an underestimate of exploitation because the low number of marked fish at large precludes accurate estimates for the early season.

Within reasonable limits, our estimates of exploitation rates are supported by fishery catch totals and abundance index findings. Differences between our 1991 abundance index for John Day Reservoir and an index computed from 1986 data (Beamesderfer et al. 1987) indicates that during 1991, the population of northern squawfish  $\geq 250$  mm fork length in John Day Reservoir was approximately 108,000. The combined 1991 catch for all fisheries in John Day Reservoir was approximately 12,500 fish (more than 90% of the northern squawfish caught during the sport reward fishery and returned to stations on John Day Reservoir were caught elsewhere). Total exploitation of northern squawfish in John Day

Reservoir was therefore approximately **11.6%**, which is similar to our adjusted estimate of 11.3%.

Results from **1991** indicate that marking fish only at dams may lead to underestimates of sport reward and overestimates of dam angling exploitation rates. We will improve our mark and recapture approach during **1992** by conducting boat sampling to mark fish throughout the lower Columbia and Snake rivers prior to the start of fisheries. We will also mark more fish during index sampling, and use the lure trolling boat to increase the number of fish marked. Random boat sampling should result in adequate mixing of marked and unmarked fish, and therefore decrease the bias of our exploitation rate estimates. This will also provide us the opportunity to increase the number of marked fish downstream from Bonneville Dam and upstream from Lower Granite Dam, two areas of high sport reward effort and catch.

There appears to be some difference among fisheries in the size of northern squawfish caught. The mean fork length of fish caught in the sport reward fishery was lower than in other fisheries. The mean fork length of fish caught in the sport reward fishery would undoubtedly be even lower if fish smaller than "reward size" were included. **It is apparent that there is a trade-off among fisheries concerning number and size of fish removed.** The fisheries appeared to have little impact on the mean size of northern squawfish during **1990** or **1991**.

Biological data collected during **1990** and **1991** yielded initial information on fecundity, age and growth, and mortality of northern squawfish in lower Columbia and Snake river reservoirs. Data will continue to be collected in subsequent years to determine if compensation effects are occurring in each reservoir.

During 1990 sufficient ovary samples were obtained only from Bonneville Dam tailrace and Bonneville reservoir to determine baseline egg production characteristics of northern squawfish. During **1991**, we obtained sufficient samples from most of the lower Columbia and Snake river reservoirs. Because compensatory effects may be masked by natural variability in egg production, conclusions regarding changes in fecundity of northern squawfish cannot be ascertained until many samples have been collected in each of a number of years. Additional ovary samples will be collected during **1992** from lower Columbia and Snake river reservoirs, as well as downstream from Bonneville Dam tailrace.

Growth and mortality are important factors in determining the effectiveness of predator control fisheries. Exploitation has in some instances resulted in population overcompensation in year class recruitment (Riemen and Beamesderfer **1990**). Collection of northern squawfish scale samples for determination of these factors will continue in each of the lower Columbia and Snake river reservoirs. Age at maturity will also be summarized.

We have observed some differences in growth rates of northern squawfish between the lower Columbia and Snake rivers. We will analyze additional scale samples to determine if differences in growth among reservoirs are associated with differences in sex ratio of fish sampled.

Catch rate of northern squawfish by trolling lures was much higher during 1991 (1.35 fish per hour) than during 1990 (0.55 fish per hour; Vigg et al. 1991). This was mostly a result of concentrating effort on lures and locations with the most success in 1990, as well as beginning effort earlier in the year when catch rates in all fisheries are typically highest.

The entire lure trolling catch for 1991 occurred near juvenile **salmonid** bypass areas. Sampling in other areas of Bonneville Dam **tailrace** and **forebay** also produced very low catch rates in 1990 (Vigg et al. 1991). These results indicate that success of trolling lures to remove northern squawfish may be very area specific. Lure trolling can achieve very high catch rates in areas of high concentration of juvenile salmonids that are attracting large numbers of northern squawfish. During periods of high catch rates in the juvenile **salmonid** bypass area during 1991, more than thirty northern squawfish per hour were collected. At other times catch rates were extremely low. We believe lure trolling could most efficiently be used as a supplemental removal method during periods when northern squawfish are concentrated in a relatively small area, such as near a juvenile **salmonid** bypass. During 1992, we will use lure trolling only as a supplemental sampling method to mark and release northern squawfish during spring.

## REFERENCES

- Bagenal, T. B. **1968.** Fecundity. Pages **160-169** in W. E. Ricker, editor. Methods for assessment of fish production in freshwater. International Biological Programme Handbook 3, Blackwell Scientific Publications, Oxford, England.
- Beamesderfer, R. C., and B. E. Rieman. **1988.** Predation by resident fish on juvenile salmonids in a mainstream Columbia River reservoir: Part **III.** Abundance and distribution of northern squawfish, walleye, and smallmouth bass. Pages 211-248 *in* T. P. Poe and B. E. Rieman, editors. Predation by resident fish on juvenile salmonids in John Day Reservoir, Volume **I** - Final report of research. Contract numbers DE **AI79-82BP35097** and DE **AI79-82BP34796.** Final Report to Bonneville Power Administration, Portland, Oregon.
- Beamesderfer, R. C., B. E. Rieman, **J.C. Elliott,** A. A. Nigro, and D. L. Ward. **1987.** Distribution, abundance, and population dynamics of northern squawfish, walleye, smallmouth bass, and channel catfish in John Day Reservoir, 1986. Oregon Department of Fish and Wildlife, Contract number DE **AI79-82BP35097.** **1986** Annual Report to Bonneville Power Administration, Portland, Oregon.
- Jearld, W. E. **1983.** Age determination. Pages 301-323 in L. A. Nielsen and D. L. Johnson, editors. Fisheries techniques. American Fisheries Society, Bethesda, Maryland.
- Nigro, A. A., R. C. Beamesderfer, **J.C. Elliott,** M. P. Faler, L. M. Miller, B. L. Uremovich, and D. L. Ward. **1985.** Abundance and distribution of walleye, northern squawfish, and smallmouth bass in John Day Reservoir, **1985.** Oregon Department of Fish and Wildlife, Contract number DE **AI79-82BP35097.** **1985** Annual Report to Bonneville Power Administration, Portland, Oregon.
- Petersen, J. H., D. B. Jepsen, R. D. Nelle, R. S. Shively, R. A. Tabor, and T. P. Poe. **1991.** System-wide significance of predation on juvenile salmonids in Columbia and Snake River reservoirs. U. S. Fish and Wildlife Service, Contract number DE **AI79-90BP07096.** **1990** Annual Report to Bonneville Power Administration, Portland, Oregon.
- Ricker, W. E. **1975.** Computation and interpretation of biological statistics of fish populations. Fisheries Research Board of Canada Bulletin **191.**
- Rieman, B. E., and R. C. Beamesderfer. **1990.** Dynamics of a northern squawfish population and the potential to reduce predation on juvenile salmonids in a Columbia River Reservoir. North American Journal of Fisheries Management **10:228-241.**
- Rieman, B. E., R. C. Beamesderfer, S. Vigg, and T. P. Poe. **1991.** Estimated loss of juvenile salmonids to predation by northern squawfish, walleyes, and smallmouth bass in John Day Reservoir, Columbia River. Transactions of the American Fisheries Society **120:448-458.**

- SAS Institute, Inc. 1987. SAS/STAT guide for personal computers, version 6 edition. SAS Institute, Inc., Cary, North Carolina.
- Shively, R. S., R. A. Tabor, R. D. Nelle, D. B. Jepsen, J.H. Petersen, S.T. Sauter, and T.P. Poe. 1992. System-wide significance of predation on juvenile salmonids in Columbia and Snake River reservoirs. U.S. Fish and Wildlife Service, Contract number DE **AI79-90BP07096**. 1991 Annual Report to Bonneville Power Administration, Portland, Oregon.
- Vigg, S., and C.C. Burley. 1991. Developing a predation index and evaluating ways to reduce **salmonid** losses to predation in the Columbia River basin. Pages 6-78 *in* A.A. Nigro, editor. Developing a predation index and evaluating ways to reduce **salmonid** losses to predation in the Columbia River basin. Oregon Department of Fish and Wildlife, Contract number DE **AI79-88BP92122**. Final Report to Bonneville Power Administration, Portland, Oregon.
- Vigg, S., C.C. Burley, D.L. Ward, C. Mallette, S. Smith, and M. Zimmerman. 1991. Development of a system-wide predator control program: **Stepwise** implementation of a predation index, predator control fisheries, and evaluation plan in the Columbia River basin. Oregon Department of Fish and Wildlife, Contract number DE **BI79-90BP07084**. 1990 Annual Report to Bonneville Power Administration, Portland, Oregon.

Appendix G-1. Size distribution of tagged and recaptured northern squawfish.

Appendix Table G-1.1. Observed and expected numbers of tagged northern squawfish recaptured during 1990, grouped by 25-mm fork length intervals. The critical value of Chi square is 22.362 (13 degrees of freedom;  $\alpha = 0.05$ ). The calculated Chi square is 18.623.

Fork length interval (mm)	Number tagged	Recaptures	
		Observed	Expected
250-274	3	0	0.043
275-299	46	0	0.661
300-324	125	1	1.797
325-349	337	4	4.845
350-374	523	5	7.518
375-399	806	3	11.587
400-424	834	13	11.989
425-449	773	15	11.112
450-474	573	15	8.237
475-499	312	4	4.485
500-524	89	3	1.279
525-549	29	1	0.417
550-574	--		
575-599	2	0	0.029

Appendix Table G-1.2. Observed and expected numbers of tagged northern squawfish recaptured during 1991, grouped by 25-mm fork length intervals. The critical value of Chi square is 21.026 (12 degrees of freedom;  $\alpha = 0.05$ ). The calculated Chi square is 46.113.

30, Fork length interval (mm)	Number tagged	Recaptures	
		Observed	Expected
250-274	155	3	7.626
275-299	429	11	21.106
300-324	715	17	35.176
325-349	1,003	33	49.345
350-374	1,146	53	56.380
375-399	1,170	61	57.561
400-424	1,312	66	64.547
425-449	1,207	77	59.381
450-474	867	60	42.654
475-499	424	34	20.860
500-524	139	5	6.838
525-549	25	2	1.230
550-574	6	1	0.295





Appendix G-2. Mark and recapture data used to estimate exploitation of northern squawfish.

Appendix Table G-2.1. Exploitation of northern squawfish in the commercial **longline** fishery in John Day Reservoir, 11 June - 9 August, 1990. E is exploitation rate.

Period	Catch	Recaptures	Number marked	Marked fish removed	Marked fish at large	E
1	--	--	155	0	0	--
2	--	--	2	0	155	--
3	--	--	151	1	157	--
4	420	1	0	2		
5	706	1	746	4	307 305	0.0033 0.0033
6	79	0	223			0.0
7	180	1	269	2	1,067	0.0008
8	--	--	31	9	1,533	--
Totals	1,385	3	1,577	22		0.0074

Appendix Table G-2.2. Exploitation of northern squawfish in the sport reward fishery in John Day Reservoir, 24 May - 30 August, 1990. E is exploitation rate.

Period	Catch	Recaptures	Number marked	Marked fish removed	Marked fish at large	E
	--	--	155	0	0	--
2	15	0	2	1	155	
4	105	1	151	2	307 157	:::064
5	343 135	1	0			0: 0033
6		1	746	4	305	0.0033
7	1,137 488	1	223	4		0.0010
		0	269	2	1,047 1,266	0' 0
8	2,435	4	31	9	1,533	0.0026
Totals	4,658	8	1,577	22		0.0166

Appendix Table G-2.3. Exploitation of northern squawfish in the dam angling fishery in John Day Reservoir, April 30 - August 30, 1990. E is exploitation rate.

Period	Catch	Recaptures	Number marked	Marked fish removed	Marked fish at large	E
<b>1</b>						
<b>2</b>	299163	--	155	<b>0</b>	<b>0</b>	--
				<b>0</b>	<b>155</b>	<b>0.0</b>
<b>3</b>	155	<b>0</b>	<b>15</b>	<b>1</b>	157	<b>0.0064</b>
<b>4</b>	470	<b>0</b>	<b>0</b>	<b>2</b>	307	<b>0.0</b>
<b>5</b>	1,189	<b>4</b>	<b>746</b>	<b>4</b>	305	<b>0.0131</b>
<b>6</b>	753	<b>8</b>	269223	<b>4</b>	1,047	<b>0:0038</b>
<b>7</b>				<b>2</b>	1,266	<b>0.0063</b>
<b>8</b>	510512	5	31	9	1,533	<b>0.0033</b>
Totals	4,051	22	1,577	22		0.0329

Appendix Table G-2.4. Exploitation of northern squawfish in the dam angling fishery in Bonneville Dam tailrace, 30 April - 30 August 1990. E is exploitation rate.

Period	Catch	Recaptures	Number marked	Marked fish removed	Marked fish at large	E
<b>1</b>	<b>29</b>	--	16	<b>0</b>		
<b>2</b>	<b>0</b>	<b>0</b>	0	<b>0</b>	16	--
<b>3</b>	<b>77</b>	<b>0</b>	72	<b>0</b>	<b>16</b>	
<b>4</b>	0	0	0	<b>0</b>	<b>88</b>	E 00
<b>5</b>	389	2	341	<b>0</b>	88	<b>0:0227</b>
<b>6</b>	149	0	140	<b>0</b>		<b>0.0</b>
<b>7</b>	239	1	161	<b>0</b>	<del>489</del>	<b>0.0018</b>
<b>8</b>	167	1	0	<b>1</b>	730	<b>0.0014</b>
Totals	1,050	4	730	1		0.0259

Appendix Table G-2.5. Exploitation of northern squawfish in the dam angling fishery in Bonneville Reservoir, 30 April - 30 August, 1990. E is exploitation rate.

Period	Catch	Recaptures	Number marked	Marked fish removed	Marked fish at large	E
1	19	--	8	0	0	--
2	94	0	0	0	8	0.0
3	332	1	309	0	8	0: 1250
4	362		0	1		0.0
5	537	1	197	1	317	0.0032
6	776	4	286	2	512	0: 0078
7	806	1		0	796	0.0013
8	642	2	4010	6	1,197	0.0017
Totals	3,568	9	1,201	10		0.1390

Appendix Table G-2.6. Exploitation of northern squawfish in the dam angling fishery in The Dalles Reservoir, 30 April - 30 August, 1990. E is exploitation rate.

Period	Catch	Recaptures	Number marked	Marked fish removed	Marked fish at large	E
1	0	--	0	0	0	--
2	170	--	0	0	0	--
3	61	--	42	0	0	--
4	68	0	0	0	42	0.0
5	314	1	142	0	42	0.0032
6	275	0	141	0	184	0.0078
7	297	2	138	1	325	0.0013
8	243	1	1	0	462	0.0017
Totals	1,428	4	464	1		0.0322

Appendix Table G-2.7. Exploitation of northern squawfish in the dam angling fishery in McNary Reservoir, 30 April - 30 August, 1990. E is exploitation rate.

Period	Catch	Recaptures	Number marked	Marked fish removed	Marked fish at large	E
1	64	--	62	0	0	--
2	78	0	0	0	62	0.0
3	32	0	31	0	62	0.0
4	57	0	0	0	93	0.0
5	289	1	211	3	93	0.0108
6	160	1	80	1	301	0.0033
7	210	2	78	4	380	0.0053
8	162	1	17	1	454	0.0022
Totals	1,052	5	464	1		0.0216

Appendix Table G-2.8. Exploitation of northern squawfish in Bonneville Dam tailrace, 28 April - 28 September, 1991. R is the number of marked fish removed, T is the number of fish marked, and M is the number of marked fish at large.

Period	Recaptures			R	T	M	Exploitation	
	Sport	Dam	Misc.				Sport	Dam
1	--	--	1	1	--	446	--	--
2	--	--	--	--	--	445	--	--
3	--	--	--	-2	--	445	--	--
4	--	2		4	7	443 445	--	0.0045
5	1	3	II				0.0023	0.0068
6	1	2	1	4	25	446	0.0022	0.0045
7	--	1	--	1	54		--	0.0021
8	--	1	--	1	60	467 520	--	0.0019
9	4	1	3	8	91	579	0.0069	0.0017
10	3	1	--	4			0.0045	0.0015
11	3	--	1	4	02	662 750	0.0040	--
12	3	3	--	6	11	746	0.0040	0.0040
13	9	1	--	9	103	751	0.0120	0.0013
14	4	3	--	6	30	845	0.0047	0.0036
15	4	--	2	4	220	868	0.0046	--
16	4	1	--		83	1,082	0.0037	0.0009
17	9	--	--	9	31	1,161	0.0078	--
18	11	--	5	16	40	1,183	0.0093	--
19	2	8	1	11		1,207	0.0017	0.0066
20	--	--	--	--	;	1,205	--	--
21	1	--	--	1	--	1,208	0.0008	--
22	--	--	--	--	--	1,207	--	--
Totals	59	27	14	97	859		0.0685	0.0394

Appendix Table G-2.9. Exploitation of northern squawfish in Bonneville Reservoir, 28 April - 28 September, 1991. P is the time period, LL is commercial longline, R is the number of marked fish removed, T is the number of fish marked, and M is the number of marked fish at large.

P	Recaptures				R	T	M	Exploitation		
	Sport	Dam	LL	Misc.				Sport	Dam	LL
1	--	--	--	2	1	102	818	--		--
2	--	--	--	--	--	80	919	--		--
3	--	--	--	--	--	--	999	--	--	--
4	--	--	--	--	--	--	999		--	--
5	--	--	--	--	--	--	999	--	--	--
6	--	--	1	--	1	4	999	--	--	0.0010
7	--	--	1	--	1	38	1,002	--		0.0010
8	--	--	--	1	1	117	1,039		--	--
9	1	--	--	--	1	--	1,155	0.0009	--	--
10	1	2	--	--	3	58	1,154	0.0009	0.0017	--
11	--	1	--	--	1	73	1,209		0.0008	--
12	1	13	--	1	15	143	1,281	0.0008	0.0101	--
13	4	5	--	3	6	381	1,409	0.0028	0.0035	--
14	--	2	--	1	3	81	1,784	--	0.0011	--
15	1	--	--	--	1	102	1,862	0.0005	--	--
16	—	--	--	—	--	62	1,963	--	--	--
17	--	3	1	--	4	4	2,025	--	0.0015	0.0005
18	2	--	--	--		55	2,025	0.0010	--	--
19	2	--	--	--	i	6	2,078	0.0010	--	--
20	--	1	--	--	--	48	2,082	--	0.0005	--
21	2	--	--	--	2	--	2,130	0.0009		--
22	3	1	--	--	4	--	2,128	0.0014	0.0005	--
Totals	17	28	3	8	52	1,354		0.0102	0.0197	0.0025



Appendix Table G-2.10. Exploitation of northern squawfish in The Dalles Reservoir, 28 April - 28 September, 1991. R is the number of marked fish removed, T is the number of fish marked, and M is the number of marked fish at large.

Period	Recaptures			R	T	M	Exploitation	
	Sport	Dam	Misc.				Sport	Dam
1	--	--	--	--	--	272	--	
2	--	--	--	--	--	272		--
3	--	--	--	--	--	272	--	--
4			--	--	--	272	--	--
5	-1	-1	--	1	--	272	<b>0.0037</b>	<b>0.0037</b>
6	5		--	5	--	271	0.0185	0.0037
7	--	:	--	1	<b>67</b>	266	--	0.0038
8	1	--	--	1		332	<b>0.0030</b>	--
9	2		--	4	27	358	0.0056	<b>0.0056</b>
10	2	1	--	3	69 <sup>18</sup>	423	0.0047	0.0024
11	8	--	--		51	438	0.0183	--
12	6	1	--	87	139	481	0.0125	<b>0.0042</b>
13	3	3	--	4	87	613	0.0049	0.0016
14	5		--	7	149	696	0.0072	0.0043
15	7			11		838	0.0084	0.0060
16	3	5	--		37	864	0.0035	0.0035
17	4	3	1	75	120 <sup>58</sup>	977	0.0041	0.0010
18		1			58	1,030	0.0039	0.0049
19	4	4	11	8	62	1,080	0.0009	0.0037
20	--	1	--	--	42	1,137	--	0.0009
21	2	2	--	2	39	1,179	0.0017	0.0017
22	--	1	--	1	--	1,216	--	0.0008
Totals	54	34	1	80	1,023		<b>0.1009</b>	<b>0.0518</b>

Appendix Table G-2.11. Exploitation of northern squawfish in John Day Reservoir, 28 April - 28 September, 1991. P is the time period, LL is commercial longline, R is the number of marked fish removed, T is the number of fish marked, and M is the number of marked fish at large.

P	Recaptures				R	T	M	Exploitation		
	Sport	Dam	LL	Misc.				Sport	Dam	LL
1	--	--	--	2	2	--	1,082	--	--	--
2	--	--	--	--	--	--	1,080	--	--	--
3	--	1	--	--	1	--	1,080		0.0009	--
4	--	1	--	--	1	--	1,079		0.0009	--
5	1	--	--	1	2	--	1,078	0.0009	--	--
6	--	3	--	--	2	--	1,076		0.0028	--
7	3	4	--		4	42	1,074	0.0028	0.0037	--
8	--	4	2	II	5	157	1,112		0.0036	0.0018
9	2	11	1	--	9	289	1,264	0.0016	0.0087	0.0008
10	1	9	1	--	11	253	1,544	0.0006	0.0058	0.0006
11	3	9	--		12	342	1,786	0.0017	0.0050	--
12	7	17	1	II	25	161	2,116	0.0033	0.0080	0.0005
13	3	27	1	2	27	283	2,252	0.0013	0.0120	0.0004
14	2	33	--	--	21	537	2,508	0.0008	0.0132	--
15	--	19	--	5	10	144	3,024		0.0063	--
16	1	17	1	1	7	97	3,158	0.0003	0.0054	0.0003
17	--	14	--	1	9	64	3,248	--	0.0043	--
18	3	11	--	--	11	25	3,303	0.0009	0.0033	--
19	2	6		--	4	5	3,317	0.0006	0.0018	--
20	--	13	II	--	1	29	3,318		0.0039	--
21	--	9	--	1	5	42	3,346	--	0.0027	--
22	--	--	--	1	4	--	3,383		--	--
Totals	28	208	7	14	173	2,470		0.0148	0.0923	0.0044

Appendix Table G-2. 12. Exploitation of northern squawfish in McNary Reservoir, 28 April - 28 September, 1991. R is the number of marked fish removed, T is the number of fish marked, and M is the number of marked fish at large.

Period	Recaptures		R	T	M	Exploitation	
	Sport	Dam				Sport	Dam
1	--		--	--	268	--	--
2			--	--	268	--	--
3	--		--	--	268	--	--
4	--		--	--	268		--
5		--	--	--	268	--	--
6	2	--	2	--	268	0.0075	--
7	1		1	20	266	0.0038	--
8	1		1	37	285	0.0035	--
9	1	--	1	50	321	0.0031	--
10	1	--	1	52	370	0.0027	--
11	--		--	48	421	--	--
12	1		1	31	469	0.0021	--
13	1		1	22	499	0.0020	--
14			--	24	520	--	--
15	--		--	18	544	--	--
16	--		--	10	562		--
17	--		--		572		--
18	--	2	--	2:	579	--	0.0035
19	--		--	7	599		
20		1	1	22	606		0.0017
21			--	19	627		--
22	--		--	--	646		--
Totals	8	3	9	387		0.0247	0.0052

Table G-2.13. Exploitation of northern squawfish in Ice Harbor Reservoir, 28 April - 28 September, 1991. R is the number of marked fish removed, T is the number of fish marked, and M is the number of marked fish at large.

Period	Recaptures			R	T	M	Exploitation	
	Sport	Dam	Misc.				Sport	Dam
1	--	--	--	--	--	--	--	--
2	--	--	--	--	--	--	--	--
3	--	--	--	--	--	--	--	--
4	--	--	--	--	--	--	--	--
5	--	--	--	--	--	--	--	--
6	--	--	--	--	--	--	--	--
7	--	--	--		23	--		
8	--	--	--		91	23		--
9	--	1	--	1	58	114	--	0.0088
10	1	--	--	1	24	171	0.0058	--
11	--	4	--	3	68	194	--	0.0206
12	2	2	--	3	74	259	0.0077	0.0077
13	6	2	--	8	69	330	0.0182	0.0061
14	4	4	--	6	81	391	0.0102	0.0102
15	6	2	--	7	20	466	0.0129	0.0043
16	3	1	--	4	11	479	0.0063	0.0021
17	1	--	--	1	24	486	0.0021	
18	1	7	2	6	24	509	0.0020	0.0138
19	1	--	--	1	72	527	0.0019	--
20					26	598	--	
21	--	--	--		20	624	--	
22	1	--	--	1		644	0.0016	
Totals	26	23	2	42	685		0.0687	0.0736

Appendix Table G-2.14. Exploitation of northern squawfish in Lower Monumental Reservoir, 28 April - 28 September, 1991. R is the number of marked fish removed, T is the number of fish marked, and M is the number of marked fish at large.

Period	Recaptures			R	T	M	Exploitation	
	Sport	Dam	Misc.				Sport	Dam
1	--	--	--	--	--			
2							--	--
3						--	--	--
4							--	--
5	--	--	--	--	--	--	--	--
6	--	--	--	--	--	--	--	--
7				--	--	--	--	--
8	--	--	--	--	117	--	--	--
9	--	--	1	1	57	117	--	--
10	--	--	--	--	16	173	--	--
11	--	3	1	4	14	189	--	0.0159
12	4	--	--	4	29	199	0.0201	--
13	3	1	--	4	19	224	0.0134	0.0045
14	4	--	--	4	30	239	0.0165	--
15	1	--	--	1	21	265	0.0038	--
16	6	2	--	7	33	285	0.0211	0.0070
17	1	3	--	3	55	311	0.0032	0.0096
18	2	1	--	2	162	363	0.0055	0.0028
19	--	2	--	--	105	523	--	0.0038
20	--	2	14	1	99	628	--	0.0032
21	1	1	--	2	10	726	0.0014	0.0014
22						734		--
Totals	22	23	16	33	767		0.0850	0.0482

Appendix Table G-2.15. Exploitation of northern squawfish in Little Goose Reservoir, April 28 - September 28, 1991. R is the number of marked fish removed, T is the number of fish marked, and M is the number of marked fish at large.

Period	Recaptures			R	T	M	Exploitation	
	Sport	Dam	Misc.				Sport	Dam
1	--	--	--	--	--	--	--	--
2	--	--	--	--	--	--	--	--
3	--	--	--	--	--	--	--	--
4	--	--	--	--	--	--	--	--
5	--	--	--	--	--	--	--	--
6	--	--	--	--	--	--	--	--
7	--	--	--	--	47	--	--	--
8	--	--	1	1	158	47	--	--
9	--	6	3	5	123	204	--	0.0294
10	--	--	--	--	35	322	--	--
11	8	11	--	18	63	357	0.0224	0.0308
12	4	10	--	9	72	402	0.0100	0.0249
13	2	6	--	8	84	465	0.0043	0.0129
14	--	3	--	--	45	541	--	0.0055
15	3	4	--	7	31	586	0.0051	0.0068
16	3	3	--	6	27	610	0.0049	0.0049
17	9	2	--	11	15	631	0.0143	0.0032
18	4	--	--	--	19	635	0.0063	--
19	4	2	--	6	54	654	0.0061	0.0031
20	1	6	--	5	165	702	0.0014	0.0085
21	--	1	7	4	91	862	--	0.0012
22	--	1	--	--	--	949	--	0.0011
Totals	38	55	11	80	1,029		0.0748	0.1323



Appendix G-3. Tables of backcalculated lengths, age at length keys, and von Bertalanffy growth parameters.



Appendix Table G-3.1. Age-length-frequency distribution for northern northern squawfish in Bonneville Dam tailrace, 1990.

Fork length interval (mm)	Age															Sum	
	1	2	3	4	5	6	7	8	9	10	11	12	13	14	15		
125-149					1												1
150-174			1														1
175-199				2													2
200-224				3	2												5
225-249				132				2									8
250-274				4	4	1											9
275-299				2	8	3	1										14
300-324					36				21								12
325-349				1	3	7	2										13
350-374						3	3	1	2		1						10
375-399							2	2	3	2	1						10
400-424								2	4	3	1	1					11
425-449							1	1	2	1	5						10
450-474								2		6	1						9
475-499										2	6	1	2				11
500-524											1	1	2	1			5

Appendix Table G-3.2. Age-length-frequency distribution for northern squawfish in Bonneville Reservoir, 1990.

Fork length interval (mm)	Age															Sum
	1	2	3	4	5	6	7	8	9	10	11	12	13	14	15	
50-74	1															1
75-99																
<b>100-124</b>																
125-149		3														<b>3</b>
150-174		1	1	1												<b>3</b>
175-199			2	1												3
200-224			5		1				1							7
225-249			4	2	1			1								<b>8</b>
250-274				5	4											<b>9</b>
275-299					5	5	2									12
300-324					4	5	2									11
325-349					2	8	1		1							12
350-374						1	2	3	1	3	1					11
375-399								5	3	1	3					12
400-424							3	2	2	3	2					12
425-449								2	1	4	2	1				10
450-474									1	3	2	3		1		10
475-499										1	3	4	1			9
500-524										1		2	1	2		7
525-549													1			1

Appendix Table G-3.3. Age-length-frequency distribution for northern squawfish in The Dalles Reservoir, 1990.

Fork length interval (mm)	Age															Sum	
	1	2	3	4	5	6	7	8	9	10	11	12	13	14	15		
75-99		1	1														2
100-124			4														4
125-149																	
150-174				1	1												2
175-199																	
200-224																	
225-249							1										1
250-274						4	2	1									7
275-299					2	7	4										13
300-324					2	5	2	2	1								12
325-349						3	4	1	2	1	1						12
350-374							3	4	3	1							11
375-399							4	2	6	3							15
400-424								4	4	7							15
425-449									3	4	2						9
450-474									1	2	4	1	1	3			12
475-499										1		1	4				6

Appendix Table G-3.4. Age-length-frequency distribution for northern squawfish in John Day Reservoir, 1990.

Fork length interval (mm)	Age															Sum
	1	2	3	4	5	6	7	8	9	10	11	12	13	14	15	
75-99		1														1
<b>100-124</b>																
125-149																
150-174				1	1											2
175-199																
200-224				2												2
225-249				1	1	1										3
250-274					1	5										6
275-299				1	4	2	5									13
300-324					1	6	4	1								11
325-349						1	4	4								11
350-374							2	6	2	1	1					11
375-399							5									12
400-424								3	3	2	1	3				10
425-449							1									13
450-474									3	2	1	2	4	3		10
475-499														2		2
500-524															1	1

Appendix Table G-3.5. Age-length-frequency distribution for northern squawfish in McNary Reservoir, 1990.

Fork length interval (mm)	Age															Sum	
	1	2	3	4	5	6	7	8	9	10	11	12	13	14	15		
100-124		1															1
125-149		9															9
150-174																	
175-199						1											1
200-224					1												1
225-249				1													1
250-274				2		1	1	1	1								6
275-299				1	2	3	1										7
300-324				1	1	6	1	1									10
325-349						1	4	2	1								8
350-374						1	4	3	2								10
375-399						2		4	1	4	1						12
400-424						1	2	1	3	3	2	1					13
425-449										1	5			1			7
450-474										2	1	3	3				9
475-499										1132				1	1		9

Appendix Table G-3.6. Age-length-frequency distribution for northern squawfish in Ice Harbor Reservoir, 1991.

Fork length interval (mm)	Age																Sum
	1	2	3	4	5	6	7	8	9	10	11	12	13	14	15	16	
126-149		1															1
151-174																	
176-199																	
201-224				1													1
226-249					1			1									2
251-274					221				1								6
276-299																	10
301-324					2	3435		2		1							11
326-349																	9
351-374							3314		1	2	1						11
376-399																	9
401-424								1	2	3	2	1	1				9
426-449																	8
451-474									2	2	2	2	1	2	1		6
476-499																	
501-524											1	2	1	2	2		3
526-549												1			1	1	3

Appendix Table G-3.7. Age-length-frequency distribution for northern squawfish in Lower Monumental Reservoir, **1991**.

Fork length interval (mm)	Age																Sum
	1	2	3	4	5	6	7	8	9	10	11	12	13	14	15	16	
101-124		3															3
<b>126-149</b>		8	2														10
151-174		2	2														4
<b>176-199</b>			2	3	1	1											7
<b>201-224</b>				1		1											2
<b>226-249</b>					1												
<b>251-274</b>			1	1	1	4	3		2								13
<b>276-299</b>				1	1	4	4	4	1								15
<b>301-324</b>							3	5	2	1							11
<b>326-349</b>						1	2	5	2								10
351-374							2	5	1	1	1						10
376-399								4	2	2	2						10
401-424									332				1				9
426-449										14			2				7
451-474									1		1	1		1		1	5
476-499														1			1

Appendix Table G-3.8. Age-length-frequency distribution for northern squawfish in Little Goose Reservoir, 1991.

Fork length interval (mm)	Age																Sum	
	1	2	3	4	5	6	7	8	9	10	11	12	13	14	15	16		
101-124		2																2
126-149		1																1
151-174		1	6															7
176-199		1	1	2	1													5
201-224		2	3	2	1													8
226-249					3													3
251-274				2	3	2	1	1										9
276-299				2	5	4	4											15
301-324						1	3	2	6									12
326-349					1	1	2	4	2									10
351-374							4	1	5	2	1							13
376-399							2	4	2	2								10
401-424							1		4	1	4							10
426-449										3	3	2	1					9
451-474									1	1	1	2	1	2				8
476-499									1	1	2	3		1	1			9
501-524														2	1			3
526-549														1				1



Appendix Table G-3.9. Age-length-frequency distribution for northern squawfish in Lower Granite Reservoir, 1991.

Fork length interval (mm)	Age																Sum
	1	2	3	4	5	6	7	8	9	10	11	12	13	14	15	16	
76-99		3															3
101-124		8	2														10
126-149		2	5														7
151-174			3	1													
176-199			1	1													2
201-224			2	2	2												6
226-249				1	1	1											3
251-274					1	6											7
276-299					3	3	4										10
301-324						3	1	5	1								10
326-349					1		6	2	1								10
351-374							3	4	2	1							10
376-399								1	3	4	1	1					10
401-424								1		4	5		1				11
426-449								1		3			2	1			7
451-474												2	2				4
476-499										1							1
501-524													1	1			2

Appendix Table G-3.10. Mean backcalculated fork lengths (mm) at the end of each year of life for northern squawfish from Bonneville Dam tailrace, 1990.

Year Class	Age													
	1	2	3	4	5	6	7	8	9	10	11	12	13	14
1987	75	141	157											
1986	76	123	175	210										
1985	70	135	191	229	259									
1984	72	137	187	227	265	295								
1983	72	143	196	236	276	310	338							
1982	68	139	193	236	272	307	332	358						
1981	73	145	197	241	278	316	343	369	394					
1980	77	159	217	261	298	333	362	387	414	439				
1979	82	156	211	248	281	317	346	377	406	427	448			
1978	87	131	198	239	283	313	355	384	404	424	448	466		
1977	73	168	207	249	296	337	364	387	409	434	458	474	496	
1976	79	150	176	238	267	293	320	348	375	395	432	479	498	514
N	131	131	131	130	124	108	82	65	50	38	24	8	5	1
Mean	74	143	196	237	275	311	345	374	405	431	449	472	497	514
SD	11	28	30	33	37	40	43	45	35	33	36	29	10	
Increment	74	69	53	41	38	36	34	29	31	26	18	23	25	17

Appendix Table G-3.11. Mean backcalculated fork lengths (mm) at the end of each year of life for northern squawfish from Bonneville Reservoir, 1990.

Year Class	Age														
	1	2	3	4	5	6	7	8	9	10	11	12	13	14	15
1989	45														
1988	42	138													
1987	47	143	207												
1986	40	127	198	234											
1985	42	126	193	242	278										
1984	43	137	194	244	284	315									
1983	35	131	204	251	288	319	347								
1982	42	128	183	235	281	320	352	379							
1981	40	133	196	241	279	315	343	363	379						
1980	50	139	202	241	283	318	348	377	402	426					
1979	45	136	199	235	265	300	331	362	385	408	427				
1978	42	137	196	245	299	333	363	387	413	438	460	478			
1977	37	140	188	241	288	319	351	386	418	448	466	485	509		
1976	46	141	198	225	263	298	330	364	392	416	438	459	477	493	
1975	31	126	176	204	233	265	300	323	354	378	408	421	440	464	501
N	141	140	136	124	115	98	79	69	56	46	30	17	7	4	1
Mean	43	134	197	240	281	316	346	373	395	423	442	473	485	486	501
SD	11	23	29	33	36	40	43	43	43	39	36	27	36	31	
Increment	43	91	63	43	41	35	30	27	22	28	19	31	12	1	15

Appendix Table G-3.12. Mean backcalculated fork lengths (mm) at the end of each year of life for northern squawfish from The Dalles Reservoir, 1990.

Year Class	Age													
	1	2	3	4	5	6	7	8	9	10	11	12	13	14
1988	77	83												
1987	63	84	112											
1986	70	91	132	152										
1985	84	154	227	265	293									
1984	77	137	186	236	271	294								
1983	78	132	182	226	265	298	323							
1982	76	143	204	250	288	319	341	364						
1981	74	145	197	245	289	321	348	372	392					
1980	76	142	192	246	285	317	347	372	396	416				
1979	77	143	209	245	276	309	338	365	389	410	431			
1978	81	143	190	246	298	329	359	394	414	432	458	473		
1977	73	141	202	244	274	312	346	377	403	427	445	466	485	
1976	73	119	158	196	235	265	309	337	360	387	412	435	448	461
N	121	121	120	114	113	109	90	70	56	36	17	10	8	3
Mean	76	136	189	239	278	308	339	369	393	415	435	458	471	461
SD	8	26	35	33	35	37	38	35	33	32	30	17	21	3
Increment	76	60	53	50	39	30	31	30	24	22	20	23	13	

Appendix Table G-3.13. Mean backcalculated fork lengths (mm) at the end of each year of life for northern squawfish from John Day Reservoir, 1990.

Year Class	Age														
	1	2	3	4	5	6	7	8	9	10	11	12	13	14	15
1988	61	96													
1987															
1986	80	140	178	214											
1985	74	140	188	227	260										
1984	67	137	192	234	264	290									
1983	64	129	189	242	282	313	338								
1982	67	132	191	241	278	307	332	353							
1981	64	143	195	257	299	333	359	385	403						
1980	64	129	190	232	268	304	335	357	376	396					
1979	59	111	149	202	227	260	292	322	341	370	389				
1978	69	130	184	227	264	295	323	347	366	389	411	431			
1977	62	129	184	219	253	283	311	335	361	388	415	439	454		
1976	66	132	192	224	258	285	308	335	359	381	403	423	443	460	
1975	53	107	134	170	234	268	291	324	370	395	423	441	468	481	502
N	108	108	107	107	102	94	79	58	44	32	25	22	15	9	
Mean	66	133	188	234	271	302	331	353	374	387	407	431	449	462	50:
SD	11	27	34	35	36	35	35	32	33	28	27	19	15	18	
Increment	66	67	55	46	37	31	29	22	21	13	20	24	18	13	40

Appendix Table G-3.14. Mean backcalculated fork lengths (mm) at the end of each year of life for northern squawfish from McNary Reservoir, 1990.

Year Class	Age														
	1	2	3	4	5	6	7	8	9	10	11	12	13	14	15
1988	38	114													
1987															
1986	49	145	214	258											
1985	46	137	202	239	269										
1984	47	142	213	258	290	318									
1983	44	140	211	254	288	315	343								
1982	44	130	195	244	282	309	332	354							
1981	47	143	205	251	287	315	337	360	383						
1980	44	131	195	244	281	312	340	366	389	416					
1979	46	147	206	254	290	321	348	373	400	421	443				
1978	43	156	216	250	285	316	344	373	394	417	438	461			
1977	43	145	194	223	275	315	330	354	372	395	415	444	464		
1976	47	119	184	250	280	313	333	353	369	389	408	426	443	458	
1977	38	120	187	237	259	285	316	337	358	383	403	435	453	472	491
N	104	104	94	94	89	85	69	56	44	35	24	12	6	3	1
Mean	45	138	205	250	285	315	340	363	389	413	433	449	455	462	491
SD	9	28	33	33	35	36	34	35	36	29	28	25	15	26	
Increment	45	93	67	45	35	30	25	23	26	24	20	16	6	7	29

Appendix Table G-3.15. Mean backcalculated fork lengths (mm) at the end of each year of life for northern squawfish from Ice Harbor Reservoir, 1991.

Year Class	Age															
	1	2	3	4	5	6	7	8	9	10	11	12	13	14	15	16
1989	98	140														
1988																
1987	78	108	161	209												
1986	78	162	213	240	261											
1985	79	143	193	232	254	284										
1984	79	142	198	240	266	295	307									
1983	81	145	203	246	273	294	311	332								
1982	82	171	229	264	291	317	336	353	374							
1981	83	153	215	260	287	306	327	349	366	387						
1980	83	155	211	256	288	312	338	355	372	388	407					
1979	89	158	226	266	292	316	344	366	387	410	435	456				
1978	78	139	198	251	290	319	345	366	393	413	433	449	468			
1977	95	183	227	268	292	319	343	358	376	395	422	438	451	468		
1976	85	161	221	256	289	311	330	353	379	410	433	451	476	494	510	
1975	72	132	198	260	287	343	360	382	397	426	452	469	490	508	519	531
N	96	96	95	95	94	89	83	66	51	43	34	21	15	9	5	1
Mean	82	152	209	250	279	305	326	351	377	398	423	450	467	484	512	531
SD	9	30	34	36	34	36	37	40	40	38	40	37	31	25	24	
Increment	82	70	57	41	29	26	21	25	26	21	25	27	17	17	28	19

Appendix Table G-3.16. Mean backcalculated fork lengths (mm) at the end of each year of life for northern squawfish from Lower Monumental Reservoir, 1991.

Year Class	Age															
	1	2	3	4	5	6	7	8	9	10	11	12	13	14	15	16
1989	55	120														
1988	46	103	160													
1987	46	113	169	217												
1986	38	94	148	195	229											
1985	38	116	171	209	236	261										
1984	40	116	180	220	254	278	302									
1983	45	126	185	235	268	294	314	335								
1982	43	123	184	225	262	293	316	337	358							
1981	45	103	164	216	260	285	305	338	359	380						
1980	39	119	176	230	265	294	319	344	366	390	412					
1979	50	100	164	186	267	304	341	371	410	428	447	463				
1978	52	151	211	246	274	291	315	340	361	378	396	416	432			
1977	49	91	163	201	238	275	313	347	372	397	417	435	458	475		
1975	34	79	117	182	206	241	270	311	337	354	380	399	406	435	454	468
N	117	117	104	97	91	87	76	62	39	26	17	7	6	3	1	1
Mean	44	117	175	222	257	285	311	338	362	386	410	426	436	461	454	468
SD	11	31	36	35	34	33	33	36	42	36	28	25	25	28		
Increment	44	73	58	47	35	28	26	27	24	24	24	16	10	25		14



Appendix Table G-3.17. Mean backcalculated fork lengths (mm) at the end of each year of life for northern squawfish from Little Goose Reservoir, 1991.

Year Class	Age														
	1	2	3	4	5	6	7	8	9	10	11	12	13	14	15
1989	56	141													
1988	40	91	164												
1987	43	126	178	226											
1986	37	118	180	215	252										
1985	41	130	192	227	257	288									
1984	43	130	191	245	276	303	327								
1983	44	125	195	239	273	300	318	343							
1982	42	130	191	240	274	302	327	348	368						
1981	46	138	190	240	277	312	345	371	393	413					
1980	46	132	196	247	285	313	343	367	391	414	430				
1979	53	164	224	264	308	334	357	379	400	418	438	459			
1978	41	128	179	221	266	300	332	360	377	393	410	428	447		
1977	39	133	206	256	299	325	353	377	402	424	440	460	472	495	
1976	35	131	178	230	302	324	361	382	403	418	436	456	471	488	501
N	135	135	128	118	110	96	88	71	59	38	28	17	10	8	2
Mean	43	128	190	238	275	307	335	360	385	415	433	455	467	494	501
SD	10	32	38	38	37	35	37	37	38	28	26	24	25	28	20
Increment	43	85	62	48	37	32	28	25	25	30	18	22	12	27	7

Appendix Table G-3.18. Mean backcalculated fork lengths (mm) at the end of each year of life for northern squawfish from Lower Granite Reservoir, 1991.

Year Class	Age													
	1	2	3	4	5	6	7	8	9	10	11	12	13	14
1989	47	106												
1988	41	93	144											
1987	40	86	146	195										
1986	45	116	171	217	263									
1985	44	108	161	200	236	272								
1984	45	130	185	233	271	298	324							
1983	42	120	179	228	270	300	326	349						
1982	41	111	168	224	265	291	315	335	356					
1981	43	107	169	230	272	311	341	366	386	411				
1980	50	133	192	232	278	302	329	346	369	391	409			
1979	48	109	176	219	257	284	315	347	371	391	409	435		
1978	47	122	178	226	273	300	321	346	369	393	413	436	454	
1977	46	121	166	223	277	301	330	354	378	401	428	454	469	486
N	117	117	104	91	86	78	65	51	37	30	17	11	8	2
Mean	44	112	169	222	265	296	327	351	373	401	413	439	458	486
SD	7	25	31	33	35	31	30	32	29	29	29	35	36	54
Increment	44	68	57	53	43	31	31	24	22	28	12	26	19	28

Appendix Table G-3.19. Von Bertalanffy growth parameters for northern squawfish captured in 1990 and 1991.  $L_{\infty}$  = maximum asymptotic fork length, K = growth coefficient, and  $t_0$  = theoretical age at which fish length = 0.

Year, reservoir	$L_{\infty}$	K	$t_0$
1990			
Bonneville Dam <b>tailrace</b>	648	0.109	-0.122
Bonneville Reservoir	544	0.172	0.751
The Dalles Reservoir	583	0.125	-0.109
John Day Reservoir	595	<b>0.109</b>	<b>-0.295</b>
<b>McNary</b> Reservoir	512	0.188	0.768
1991			
John Day Reservoir	516	0.175	0.635
Ice Harbor Reservoir	637	<b>0.101</b>	-0.400
Lower Monumental Reservoir	531	0.139	0.377
Little Goose Reservoir	553	0.155	0.662
Lower Granite Reservoir	588	<b>0.119</b>	<b>0.241</b>





## REPORT H

### Economic, Social, and Legal Feasibility of Commercial, Sport and Bounty Fisheries on Northern Squawfish

Prepared by:

Susan Hanna<sup>\*</sup>, Jon Pampush<sup>\*</sup>, Michael Morrissey<sup>\*\*</sup>, Dongdong Lin<sup>\*\*\*</sup>

<sup>\*</sup>Department of Agricultural and Resource Economics  
Oregon State University

<sup>\*\*</sup>Oregon State University Seafood Laboratory

<sup>\*\*\*</sup>Department of Food Science and Technology  
Oregon State University



## CONTENTS

	<u>Page</u>
ACKNOWLEDGMENTS.....	441
ABSTRACT.....	442
INTRODUCTION.....	443
METHODS.....	443
Fishery Operations.....	443
Distribution of Catch.....	445
Catch Utilization.....	447
Social Issues.....	450
Regulatory Issues.....	451
RESULTS.....	452
Fishery Operations.....	452
Commercial Fishery.....	<b>452</b>
Dam Angling Fishery.....	<b>452</b>
Sport-Reward Fishery.....	<b>452</b>
Experimental Purse Seine Fishery.....	<b>453</b>
Distribution of Catch.....	453
Collection System.....	453
Fish Distribution and Costs.....	454
Utilization Participants.....	459
Catch Utilization.....	460
OSU Minced Product Experiments.....	460
Stoller Minced Food Product.....	462
Fish Meal.....	462
Grizzly Bear Bait.....	462
Liquid Fertilizer.....	462
Mink Feed.....	463
Shad Bycatch.....	463
Social Issues.....	463
Commercial Fishery.....	463
Dam Angling Fishery.....	464
Sport-Reward Fishery.....	465
Experimental Purse Seine Fishery.....	466
Tribal Fishery Development.....	466
Regulatory Issues.....	<b>467</b>
Contaminants.....	<b>467</b>
Regulatory Review.....	467
Tribal Assessments.....	469



DISCUSSION .....	469
Fishery Operations .....	469
Distribution of Catch .....	470
Catch Utilization .....	472
Social Issues .....	474
Regulatory Issues .....	475
REFERENCES .....	477
APPENDIX H-1. Sport-Reward Fishery Data Forms .....	479
H-1.1. Sport-Reward Fishery Survey Form .....	481
H-1.2. Sport-Reward Fishery Nonreturning Angler Survey Form .....	485
H-1.3. Sport-Reward Fishery Creel Clerk Survey Form .....	487
APPENDIX H-2. Experimental Purse Seine Fishery Logbook Form .....	491
APPENDIX H-3. OSU Seafood Laboratory Experiments .....	495
H-3.1. Proximate Analysis of N. Squawfish Mince .....	497
H-3.2. Weight Distribution of Squawfish .....	499
H-3.3. Length Distribution of Squawfish .....	501
H-3.4. Weight/Length Relationship of Squawfish .....	503
H-3.5. Gill Color with Days on Ice .....	505
H-3.6. Gill Odor with Days on Ice .....	507
H-3.7. Eye Color with Days on Ice .....	509
H-3.8. Texture with Days on Ice .....	511
H-3.9. General Appearance With Days on Ice .....	513
H-3.10. Torrymeter Reading for Head Region .....	515
H-3.11. Torrymeter Reading for Middle Region .....	517
H-3.12. Torrymeter Reading for Tail Region .....	519
H-3.13. Muscle pH of Squawfish .....	521
H-3.14. TBA of Squawfish .....	523
H-3.15. Changes in Total Plate Count .....	525
H-3.16. Stress/Strain for Squawfish .....	527
H-3.17. Squawfish Grading Guide .....	529
APPENDIX H-4. Nutritive Composition of Stoller Fisheries Fish Meal .....	535
APPENDIX H-5. OSU Mink Feeding Experiments .....	537
H-5.1. Diet Composition of Experimental and Control Groups .....	538
H-5.2. Weights of Experimental and Control Groups .....	539
APPENDIX H-6. Report on Columbia River Shad Fisheries .....	541
APPENDIX H-7. Commercial Longline Fishery .....	551
H-7.1. Commercial Longline Fishery Agency Expenditures .....	552
H-7.2. Commercial Fishery Observer Survey Form .....	553
APPENDIX H-8. Dam Angling Fishery .....	557
H-8.1. Dam Angling Fishery Agency Expenditures .....	558

APPENDIX H-9.	Sport-Reward Fishery.....	559
H-9.1.	Agency Expenditures for Fishery Operation by Site.....	560
H-9.2.	Total Agency Expenditures for Fishery Operations.....	561
H-9.3.	Creel Clerk Assessment of Fishery Components.....	562
H-9.4.	Creel Clerk Recommendations for Changes in Operation..	565
APPENDIX H-10.	Experimental Purse Seine Fishery.....	567
H-10.1	Operating Costs of the Purse Seine Fishery.....	570
APPENDIX H-11.	Comparison of Sport, Commercial, and Dam Fisheries.....	571
H-11.1.	Monitoring Systems Expenditures.....	569
APPENDIX H-12.	Contaminant Tests.....	570
H-12.1.	Results of Dioxin Tests.....	571
H-12.2.	Results of Hydrocarbon and <b>Organo</b> Phosphates Screen on Fish Oil .....	573
H-12.3.	Results of PCB Screen on Fish Meal .....	575



## ACKNOWLEDGMENTS

We thank our fellow researchers who have provided information and assistance to this project: Greg Hueckel and Craig Burley of the Washington Department of Wildlife, Tom Iverson and Steve Mathews of the University of Washington, Christine Mallette, Dave Ward, Mark Zimmerman and Tony Nigro of the Oregon Department of Fish and Wildlife, Roy Beaty and Blaine Parker of the Columbia River Intertribal Fish Commission, Earl Dawley and Bruce Monk of the National Marine Fisheries Service.

We thank other cooperators on the project who have provided information on the utilization of northern squawfish: Larry Stoller of Stoller Fisheries, Inc., Ron Scott of the Oregon State University Experimental Fur Farm, Jim Bahrenberg of Inland Pacific Fisheries, enforcement personnel of the Oregon Department of Fish and Wildlife, the Washington Department of Wildlife, and the Columbia River Inter-Tribal Fish Commission, administrators of the U.S. Army Corps of Engineers, commercial fishery observers, creel clerk supervisors, and anglers who generously answered our phone survey questions.

We thank the many people who worked on and contributed to this project throughout the season: Jennifer Beyer, Dan File, Rich Coparanis, Tom Lorz, Dolly Hughes, Donna Atto, Patsy Claussen, and Walt Ransom.

## ABSTRACT

We report on our research conducted from 1 April **1991** through 31 August **1991** to continue to analyze economic, social and legal feasibility of commercial, sport and bounty fisheries on northern squawfish (*Ptychocheilus oregonensis*). Northern squawfish were provided to this project from four sources: the commercial **longline** fishery, the sport-reward fishery, the dam angling fishery, and the experimental purse seine fishery.

We evaluated the operations of the four fisheries: commercial longline, sport-reward, dam angling, and experimental purse seine.

We developed an extensive collection, transportation, storage and delivery system for northern squawfish landed by the commercial longline, sport-reward, and dam angling fisheries.

We continued to evaluate a range of alternative end uses for northern squawfish. These included minced food products, fish meal, restaurants, retail markets, bear bait, mink feed, and liquid fertilizer.

We conducted an assessment of social issues related to the four fisheries, including positive interactions as well as conflicts. We surveyed participants and employees of each fishery as well as enforcement personnel to identify areas of potential concern in the continued operation of these fisheries.

We conducted a **followup** to the **1991** assessment of regulatory factors identified as important to the development of a full-scale commercial, **sport-reward**, or dam angling fishery on northern squawfish.

## INTRODUCTION

The **1991** season continued our research of the feasibility of alternative fisheries for northern squawfish (*Ptychocheilus oregonensis*) first begun in February **1989**. This report summarizes our research activities and results during the first five months of the **1991** project, until 31 August **1991**. Our **1991** project has five objectives related to the continued evaluation of the economic feasibility of commercial and bounty fisheries on northern squawfish. These five objectives are listed below.

1. Continue to evaluate the economic effectiveness of sport, bounty and commercial fisheries on northern squawfish.
2. Collect, transport, store and distribute all northern squawfish collected during the **1991** fishing season.
3. Continue to evaluate the market potential of northern squawfish products and include new products that were not tested during **1990**.
4. Evaluate the market potential and regulatory issues related to the incidental harvest of shad (*Alosa sapidissima*) in the purse seine fishery for northern squawfish.
5. Expand the evaluation of the legal feasibility of sport, bounty, and commercial fisheries for northern squawfish to include social and institutional factors.

This report presents results of research activities conducted under the five project objectives through 31 August. Discussions are presented on five subject areas: fishery operations, distribution of catch, catch utilization, social issues and regulatory issues.

At the time of this report writing, several sources of data are still in preparation or in process but not complete. These include: commercial fishery trip cost data, commercial fishery observer summaries, sport-reward fishery voucher data, sport-reward fishery nonreturning anglers survey, sport-reward fishery agency expenditure data, dam angling fishery expenditure data, enforcement personnel summaries, dioxin test results, and full tribal assessment of fishery development issues.

## METHODS

### Fishery Operations

Sites of fishery operations expanded in **1991**. Harvest sites included eight mainstem dams and the John Day Reservoir of the Columbia River. Northern squawfish were harvested by four different types of fisheries: commercial longline, sport-reward, dam angling, and experimental purse seine.

Northern squawfish harvested by these fisheries were provided to the this project during different time periods. The dam angling fishery was conducted between 6 May and 1 October. The sport-reward fishery operated between 24 May

and 22 September. The commercial **longline** fishery ran between 11 June and 3 August.

Operations of the four northern squawfish test fisheries were monitored by this project for logistics of operations, collection and handling systems, total catch per site, agency expenditures, total expenditures, and actual or potential conflicts.

Sources of data to assess fishery operations varied by fishery. Commercial fishery operations were monitored by four data sources: operating costs per fishing trip, interviews with commercial fishery observers, a survey of commercial fishermen, and agency expenditures. Data on operating costs were collected per trip, incorporated into a trip logbook form developed by the Oregon Department of Fish and Wildlife (ODFW). A survey of participating commercial fishermen was conducted, also by the ODFW. A list of commercial fishery observers has been provided to this project for the purpose of conducting telephone interviews to assess fishery operations. Data on expenditures incurred by the ODFW to set up and operate the commercial fishery have also been provided.

Operations of the dam angling fishery were monitored by sources of data: catch data, agency expenditures, and two summary assessments of dam angling fishery operations, provided by the Columbia River Intertribal Fish Commission (CRITFC) and the ODFW. Data forms developed by the CRITFC developed by the ODFW project which incorporated all data requirements for the feasibility analysis. The major question of interest to the feasibility project concerning the dam angling removal method is the effectiveness (in terms of northern squawfish removals) per unit cost. Cost effectiveness of the dam angling fishery is compared to the cost effectiveness of the two other major removal methods: commercial longlining and recreational angling. Data elements required for the feasibility analysis are fishing effectiveness expressed in catch per unit effort, incidental catch, gear, bait, time spent fishing, labor costs, and equipment costs.

Six sources of data provided monitoring of the sport-reward fishery: vouchers, registration forms, catch weight, agency expenditures, a survey of creel clerks, and a survey of nonreturning anglers. We revised the survey instrument used in 1990 to collect data from the sport-reward fishery. The angler survey included questions on time spent fishing, fishing method, gear used, catch, incidental catch, residence, distance travelled to fish, fishing experience, expenditures associated with fishing, experience with northern squawfish, and opinions about the northern squawfish sport-reward fishery. The design of the survey instrument was coordinated with the Washington Department of Wildlife (WDW). The sport-reward fishery survey form is presented in Appendix H-1.1.

The survey was administered to every participant in the sport-reward fishery returning to a registration site. The payment voucher certifying number of northern squawfish caught was incorporated into the survey form to ensure a high level of survey response. Receipt of payment for landed squawfish was dependent on the completion of the survey form.

A significant number (approximately 60%) of anglers did not return to the registration site. A survey form was developed to administer by telephone to

a sample of nonreturning anglers. The survey form is presented in Appendix H-1.2. The registration database is currently being stratified by site and will then be systematically sampled.

We were also interested in the creel clerks' perspective on fishery operations and suggestions for improvement. Creel clerk supervisors at each registration were contacted by telephone, interviewed about any problems encountered, and asked to identify any areas of needed change in the operations of the sport-reward fishery. The telephone survey form used to interview creel clerk supervisors is presented in Appendix H-1.3.

Trip logbooks which included catch, effort and cost measures were provided by the experimental purse seine fishery. The logbook form is presented in Appendix H-2.

#### Distribution of Catch

**1991** is the second year of the predator control program that has required an extensive fish handling and transportation network. In hindsight, the **1990** program served as a pilot scale operation but proved to be unrepresentative of what was to occur in **1991**. Very high catch rates in June of **1991** and the possible development of a commercial use of the squawfish carcasses created the need for drastic modifications in the **1990** program. These modifications were implemented during the height of the removal period and proved effective for the rest of the field season.

The **1991** transportation and handling network was initially intended to be a larger version of the **1990** system. The basic strategy was to provide each field area with one or more chest freezers. Northern squawfish caught in the fisheries were to be put into plastic bags and then deposited into the chest freezers. When the freezers became full, an OSU employee would empty the freezers by hand into a large commercial fishing tote and, using a pallet jack, lift the full tote onto a truck equipped with a hydraulic lift gate. This vehicle would travel the entire project area weekly and deliver the totes to one of two cold storage facilities (Americold in Wallulla, WA, and Northwest Cold Storage in Portland, OR). Most of the frozen fish in cold storage were intended to be used by Inland Pacific Fisheries in Payette, ID.

In May and June freezers were placed in the following locations to provide fish drop off points for dam anglers (CRITFC), sport reward clerks (WDW), tribal longline observers (ODFW), lure study technicians (ODFW), and Merwin trap operators (UW). The actual number of freezers at a given site was variable depending on catch rates



<u>Location</u>	<u>Fishery</u>	<u>#Freezers</u>
Bonneville Dam	dam angling	2
Cascade Locks Field Stn.	<b>longline, lure</b> study	2
N. Bonneville Field Stn.	sport reward	5
White Salmon Field Stn.	sport reward	4
The Dalles Dam	dam angl., Merwin trap	2
Goldendale Field Stn.	sport reward	5
John Day Dam	dam angling	2
<b>McNary</b> Dam	dam angling	2
Pasco Field Stn.	sport reward	3
Ice Harbor Dam	dam angling	1
Lower Monumental Dam	dam angling	1
Little Goose Dam	dam angling	2
<b>Starbuck</b> Field Stn.	sport reward	1
Lower Granite Dam	dam angling	2
Clarkston Field Stn.	sport reward	2

In 1990, the freezer system worked well throughout the field season. However, by mid June 1991, several circumstances arose that rendered the freezer system ineffective in many areas during the 1991 season:

1. The early season catch rates were beyond expectations (especially from the sport reward fishery).
2. The number of fish caught were beyond the capacity of the chest freezers to freeze the fish (even in locations with 5 or 6 freezers).
3. Most fish arrived at the freezers **unchilled**, further reducing the likelihood of freezing.
4. When the freezers were emptied, the fish were often semi-rotten, making them unsuitable for cold storage.
5. Inland Pacific Fisheries was unable to process the volume of fish being caught, consequently the totes were accumulating at the cold storage facilities at an unexpected rate. By July 1, there were 91 totes (64,000 lbs) in cold storage.
6. If the trend continued, a very large number of totes would have to be purchased (at \$175.00 each) and the cold storage charges would be excessive.
7. If the rate of accumulation at the cold storage facilities was not curbed, there was concern that no use could be found for the hundreds of totes of squawfish in plastic bags (local rendering companies were not interested in fish in plastic bags).

In response to the above problems, the handling and transportation system was drastically modified to accommodate the large volume of fish. All but one chest freezer was removed at each location and the freezers were replaced by a variable number of 24 cubic foot insulated commercial fishing totes (one freezer was left on site for blue ice and tagged fish). Ice was provided at each location (also in the insulated totes). Fish were dropped directly into the totes and "iced down" by the dam anglers and creel clerks. The tote and ice system eliminated the need for the plastic bags. The Snake River dams, John Day dam and the Tribal **longline** field stations were not converted to the tote system due to relatively low catch rates thereby eliminating the need for frequent pickups at those locations. This feature saved thousands of vehicle miles.

Once or twice a week, depending on catch rate, the totes containing fish were picked up by a two man OSU crew and replaced by empty totes and additional ice. A second truck was rented and two more employees were hired to operate in the Snake River area. Fish from the totes were taken to Bonneville Fish in Cascade Locks Oregon, where they were then picked up twice a week by a rendering service from Portland. The new system provided for the immediate disposal of the carcasses and greatly reduced the accumulation of frozen fish in cold storage.

#### Catch Utilization

Catch of northern squawfish was utilized in seven ways in the 1991 season: two different minced food fish products, fish meal, liquid organic fertilizer, mink feed, and grizzly bear bait.

#### OSU Minced Product Experiments

The Oregon State University (OSU) Seafood Laboratory in Astoria continued to produce a prototype deboned minced squawfish product. Additional experiments were added in 1991: a determination of the proximate composition of northern squawfish; shelf-life studies, including chemical, physical, and sensory attributes of fresh iced squawfish; and tests of variability of quality of minced frozen fish as compared to minced fresh fish.

The overall objective of the OSU Seafood Laboratory experiments is to determine the normal shelf life parameters for the northern squawfish as the fishery develops. There is limited information with regard to protein and lipid content as well as how well the fish stay fresh on ice. Preliminary studies show that standard items such as fish fillets, steaks, etc. contain residual bones and are unacceptable for the average American consumer. It was decided that a more extensive study should be undertaken in a minced product from both fresh and frozen squawfish. Minced products can be shaped into various value-added products and marketed accordingly.

Fresh and frozen fish collected at dam sites were evaluated for freshness. Fresh fish meeting "food quality" standards were kept on ice and transported to the OSU Seafood Laboratory within twenty-four hours of capture. Once at the lab, fish freshness was again evaluated using a number of methods. A descriptive sensory evaluation (DSE) based on the Canadian system was developed for northern squawfish characteristics (Woyewoda and Shaw 1984). This system assigns a numerical value to inherent characteristics of northern

squawfish that are visible and can be scored. These include weight, length, gill color, odor, round fish texture, overall appearance, eye color, etc. The DSE evaluation sheets are included in Appendix H-3.17. Scoring for the DSE was from 0 to 3 with 0 showing no defects and recorded as the highest score. DSE, total plate count, Torrymeter readings, pH, and thiobarbituric acid (TBA) tests were run at three day intervals for twenty-four days for northern squawfish kept in ice.

Fish were planked with skin, washed and passed through a deboner (Ikeuchi Tekkosho, Ltd. Model 805) which separates the meat from the skin and bones. A portion of the minced flesh was saved for further analysis. The minced flesh was washed twice to remove remaining particles of skin and residual blood from the flesh. The flesh was washed in ice water at a ratio of 3:1 water to flesh. The resultant slurry was stirred, by hand, for 5 minutes and allowed to settle for 5 minutes. The temperature was kept under 10 degrees C during the operation. The first washed slurry was passed through cheese cloth and moisture controlled to approximately 80%. For the second wash, 0.1% NaCl was added to the wash water (3:1) and the method of wash and dewatering were kept the same. Samples from the two washes were frozen for further analysis. Samples from the second wash were packed into plastic trays, vacuum sealed in vapor proof bags, and frozen in a blast freezer at -10 degrees C.

Proximate analyses were run on the fresh mince as well as the washed mince. Three homogenized composites of each sample were made for determination. Protein, moisture, and ash were analyzed using the standard AOAC procedures (1990). The protein factor was determined at x 6.25. The lipid content was measured by the method of Soxhlet. TBA was run by the method of Sinnhuber and Yu (1957), and the pH analysis by the standard Canadian method for pH determination for groundfish (Woyewoda and Shaw, 1984). Torrymeter readings were made in the upper, middle and lower portions of the fish with a minimum of three readings for each (Jason and Lees, 1971).

In addition to the DSE measurements for texture, a torsion test was undertaken for the unwashed and washed mince to determine the gelling characteristics of the fish proteins with storage. Gels were prepared from northern squawfish on each of the test days by chopping the washed or unwashed mince in a Hobart silent cutter with 2% salt added and ice sufficient to adjust the starting moisture content to 77%. The resultant paste was extruded into stainless steel tubes with a Vise sausage stuffer and capped at both ends. The tubes were cooked at 90 degrees C for 15 minutes, cooled and stored at 2 degrees C overnight. Torsion tests were performed by the method of Lanier, Hamann and Wu (1985). The cooked, gelled mince is shaped into dumbbell shapes with a diameter of 1.0 cm and twisted to failure at 2.5 rpm on a modified Brookfield viscometer. Shear stress and strain, at failure, were calculated from torque and angular displacement.

Supplies of frozen minced deboned product produced at the OSU Lab will be delivered to the four participating restaurants and markets in Portland this fall. After market tests, we will conduct follow-up interviews with these businesses to determine their evaluation of the new product form.

## Stoller Minced Food Product

Parallel minced food product experiments were performed by Stoller Fisheries of Spirit Lake, Iowa, a processor of fresh water rough fish primarily for the kosher market. Information on the conduct and results of these processing experiments is taken from the first two of three processing reports authored by Larry Stoller, president of Stoller Fisheries. Approximately 800 lbs. of whole frozen food grade northern squawfish were provided to Stoller for testing in their minced deboned fish processing line. For the purposes of these tests, "food grade" squawfish were defined as fish which had been delivered live to the freezer and then frozen.

Food grade northern squawfish were received by Stoller Fisheries solidly frozen and in good condition. The fish were defrosted for a period of 24 hours at a room temperature of 55 degrees F which resulted in a weight loss of approximately 40 lbs., or 5%. Net starting weight for processing was then 761 lbs. Internal temperature of the fish was 48-52 degrees F.

It was discovered that Stoller Fisheries processing equipment would not accept any fish <.5 lb.. A total of 25 lbs. of undersize fish were sorted out of the processing batch. If northern squawfish supplied to Stoller are representative of the size distribution of the overall catch, this percentage of undersize northern squawfish is deemed acceptable. Net weight available for processing was 735 lbs.

## Fish Meal

Two separate batches of frozen non-food grade northern squawfish were provided to Stoller Fisheries for processing. The first batch contained 594 lbs. The second batch contained 35,000 lbs. A complete report has been submitted on the first batch processing and on the nutritional composition of northern squawfish fish meal. The report on the second processing batch is in progress.

To process the first batch, the 594 lbs. of non-food grade squawfish were combined with the processing waste from the northern squawfish deboning and mincing operations. The fish was run through a grinder, then a crusher, into a cooker and screw press, and finally through a drum dryer and hammer mill. Because this sample of squawfish was not of sufficient size for analysis it was blended with residual meals already in the dryer.

## Grizzly Bear Bait

Approximately 600 lbs. of frozen northern squawfish packaged in 10-15 lb. packages were provided to the Idaho Department of Fish and Game for use in a grizzly bear research program. The program's objective was to attach radio collars to track grizzly bear movements in the Selkirk Mountains, one of four designated grizzly bear recovery zones (W. Wakkinen 1991).

## Liquid Fertilizer

A single delivery of 3,600 lbs. was delivered to Inland Pacific Fisheries **Inc.**, Payette, Idaho, for liquid fertilizer processing. Data were collected on results of the processing run.

## Mink food

Five' totes of northern squawfish, approximately 16,940 lbs., were provided to the OSU Experimental Fur Farm for mink feeding experiments. Fifty standard Dark mink, 25 each male and female, were randomly selected from the 1991 kit crop, weaned and placed in individual cages 10" wide x 24" long x 15" high, with self-waterers. The test group and the control group, also consisting of 25 each males and females Dark mink of random selection, were started on their respective diets 16 July 1991. Mink are fed once daily. Nonconsumed feed is collected and weighed before the next feeding. Animals are weighed at four week intervals. Diets of the test group and control group are detailed in Appendix H-5.1. A sample of northern squawfish was sent to a laboratory to test for the presence of the anti-metabolite thiaminase, which would have a negative impact on the use of squawfish in feeding rations.

## Shad Bycatch

An evaluation of the status of shad stocks and fishery utilization is presented in a separate report in Appendix H-6.

## Social Issues

The assessment of social issues associated with the development of full-scale fisheries for northern squawfish has been based primarily on an assessment of fishery-related conflicts. Information on any conflicts occurring either on the water or on shore during the 1991 season is being collected from participants and employees in each fishery. Information on commercial fishery conflicts was collected through a survey of fishermen conducted by the ODFW. A telephone survey of commercial fishery observers is in process.

Dam angling conflicts were identified by asking staff of both ODFW and CRITFC to summarize their experiences with the fishery, and by contacting representatives of the USACE in the Portland and Walla Walla districts. Sport-reward fishery conflicts are being identified through a summarization of angler comments on voucher forms and a telephone survey of creel clerk supervisors. Conflicts associated with the experimental purse seine fishery were identified through contact with research personnel on both the University of Washington and National Marine Fisheries Service.

The second effort in the identification of social issues related to the conduct of the fisheries was to recontact recipients of the 1990 "Regulatory Review". Representatives of various agencies and public utility districts were asked about issues specific to their interest and were asked to provide any information on any issue which arose in 1991 in conjunction with the operation of any of the fisheries.

In addition, a telephone survey of fishery management representatives of the Nez Perce Tribe, the Confederated Tribes and Bands of the Yakima Indian Nation, the Confederated Tribes of the Warm Springs Reservation of Oregon, and the Confederated Tribes of the Umatilla Indian Nation is in process to identify any nonregulatory but important issues associated with the development and operation of fisheries for northern squawfish.

The final effort in the identification of social issues will be to visit with representatives of the tribes named above to assess more fully key areas of concern with the development of fisheries for northern squawfish.

### Regulatory Issues

In 1990 the "Regulatory Review" questionnaire was administered to state fishery agencies, CRITFC, the public utility districts, the USACE, FPAC members, and CBFWA members. The purpose of the questionnaire was to identify for each of the three major fisheries for northern squawfish - commercial, dam angling, and sport-reward - any areas of conflict on regulation with existing fisheries or other interests.

The survey identified seven key areas of concern: 1) a need to determine effects of full-scale fisheries on incidentally caught fish species; 2) a need to review plans for commercial fisheries between Bonneville and McNary dams by tribal managers, state managers, other governing bodies, and parties to U.S. v. Oregon; 3) a need for reclassification of northern squawfish as food fish by the State of Washington; 4) a need to better define and address regulatory responsibilities and social considerations associated with the development of commercial fisheries; 5) a need to review and interpret regulations by Oregon, Washington and Idaho prohibiting compensation of sport anglers for catch in the sport-reward fishery; 6) a need to examine issues related to the ownership and use of access sites along the Columbia and Snake Rivers on participation in the sport-reward fishery; 7) a need to identify and address safety and security issues related to the access of federal projects for the dam angling fishery.

On the basis of the issues identified, follow-up interviews were held with 1990 survey recipients. Questions were asked of appropriate agencies about actions taken and progress made on any of the identified issues.

Concerns about the safety of human consumption of this fish were addressed in 1990 through the provision of **11** samples of northern squawfish to the Oregon Department of Environmental Quality (DEQ) Division of Water Quality Planning to test northern squawfish tissue and organs for dioxin contamination. Previous tests performed by the DEQ for pesticides (PCB's, chlordane, DDT derivatives) and heavy metals (mercury, aluminum, lead, arsenic) revealed levels safe for human consumption (Hanna **1990**).

Samples of northern squawfish and sediments taken from eleven Columbia River sites (Hanna and Pampush **1991**) were sent to the Environmental Protection Agency (EPA) Laboratory in Duluth, Minnesota for dioxin tests.

Regulatory and other issues related to the development of northern squawfish fisheries from the perspective of the tribes will be addressed through interviews with tribal representatives this fall.

## RESULTS

### Fishery Operation

#### Commercial Fishery

The commercial **longline** fishery was conducted by 30 tribal fishermen selected and outfitted by the UW project. Fishery oversight and management was provided by the Oregon Department of Fish and Wildlife. The fishery was operated as a subsidized "reward" fishery, with fishermen fishing under contract. Data on fisherman operating expenditures is still being entered and edited by ODFW, and will be included in the analysis when complete. Direct agency expenditures by category made by ODFW for the commercial **longline** fishery up to 31 August 1991 are summarized in Appendix H-7.1. Bait was provided to the commercial **longline** free of charge by the CRITFC. Fifteen gear packages were also provided free of charge by the UW project. Bait and gear expenditures are included in Appendix H-7.1.

In contrast to 1990, fishermen were not paid a fixed salary. Payment to fishermen was limited to payments for fish landed were made at a rate of \$4.00 per fish. The total number of fish caught in the **longline** fishery over the 1990 season was 1053, resulting in a total expenditure for fish payments of \$4,212.

As in 1990, indirect expenditures were also made to set up and maintain the operation of the commercial **longline** fishery. The most important of these were the time required of UW project personnel to equip fishermen at the start of the season and the time involved in consultation with fishermen and gear repair throughout the season. CRITFC personnel time was also involved in the purchase and distribution of bait. Due to the difficulty of assigning a fixed amount of time to these activities, these costs are acknowledged but unquantified.

#### Dam Angling Fishery

The 1991 dam angling fishery was conducted on eight Columbia and Snake River dams: Lower Granite, Little Goose, Lower Monumental, Ice Harbor, **McNary**, John Day, The Dalles, and Bonneville. Management and oversight of the dam angling fishery was provided by the Columbia River Inter-Tribal Fish Commission. Start dates varied by project from 6 May to 2 July. The focus of interest for the feasibility project in this fishery are fishing effectiveness (CPUE), incidental catch, and costs for gear, bait, and labor and equipment. The full dam angling data base is not yet complete.

Preliminary figures representing agency (CRITFC) expenditures through 31 August 1991 by dam on 5 dams for which data are available are presented in Appendix H-8.1. Expenditures include all expenditures dedicated to the operation and oversight of various dam angling projects. Billing for all dam angling in the 1991 season will be completed in the fall of 1991.

#### Sport-Reward Fishery

The sport-reward fishery began 24 May 1991. The voucher form developed to collect data on the sport-reward fishery is included in Appendix H-1.1. The angler survey data base is still in the process of being entered and edited.

The sport-reward fishery involved agency expenditures for creel clerk wages, reward payments, uniforms, vehicles, fuel, oil, and miscellaneous equipment. These costs are summarized through 31 August by registration site in Table H-9.2.

Preliminary figures indicate a total of \$442,486 was spent by the WDW to set up and operate the sport-reward fishery between 24 May and 31 August. A complete analysis of agency costs per unit of labor effort and per fish removed will be conducted upon completion of the sport-reward data base and will be included in the final report.

#### Experimental Purse Seine Fishery

Operating costs of the experimental purse seine fishery are detailed in Table H-10.1. For several reasons, cost effectiveness in terms of costs per fish removed is meaningless and will not be calculated for this fishery in 1991. The fishery experienced several difficulties in operation during the 1991 season. River conditions were poor for purse seining. Gear damage and loss ensued. Detailed coordination with dam and fish passage personnel delayed the start of operations. Catches of northern squawfish were low. The fishery was operated as a research fishery rather than a production fishery, meaning that generalization from experimental fishery operations to commercial fishery feasibility is not possible.

#### Distribution of Catch

The development and operation of the collection, storage, and delivery system for the 1991 northern squawfish catch changed mid-season to accommodate large quantities of fish removed by the four fisheries.

#### Collection System

##### May and June (freezer system)

May and June pickups were handled by a two man crew and a 30,000 lb covered truck equipped with a hydraulic lift gate. Typically, the crew would assemble at Rollins Truck Rental in Portland on Monday of each week and drive directly to the Snake River region of the project area, picking up Little Goose Dam, **Starbuck** Field Station, and Clarkston Field Station. The crew would lodge Monday night in Clarkston or Pullman. On Tuesday, Lower Granite, Ice Harbor, and Pasco and would be picked up and all totes would be delivered to Americold in Wallula, WA.

McNary Dam would be picked up after the Americold cold storage drop-off, completing what we refer to as the "upper river" region of the pickup route (Snake River area and McNary Dam). Lodging would be in Umatilla on Tuesday night. On Wednesday, all the remaining freezer locations would be picked up in a downstream order: John Day Dam, Goldendale Field Station, The Dalles Dam, White Salmon Field Station, Cascade Locks Field Station, and Bonneville Dam. These totes were be delivered to Northwest Ice and Cold Storage in Portland, OR., thereby completing the weekly pickup run.

The above itinerary varied greatly depending on the catch rates in a given area and time constraints. Often some freezer locations did not require



weekly visits (particularly the Snake River dams). A typical round trip would log about 1,100 miles.

Toward the end of June it became apparent that the freezer strategy was no longer viable and it was during this period the transition to the insulated tote system began. On July 1 a second crew was hired and the second truck was brought on line. From this point on, the project area was divided into the "upper" (from McNary Dam upstream) and the "lower" (from John Day Dam downstream) river regions.

Each week a crew would operate in one of these two areas and all the insulated totes containing fish would be delivered to Bonneville Fish in Cascade Locks. During the transition period, it was not unusual for the employees to log 70 hour work weeks. Totes of bagged, frozen fish from the remaining freezer locations were either delivered to cold storage or "debugged" (removed from the bags and taken to Bonneville Fish and later picked up for rendering).

#### July through September (insulated tote system)

Typically, the two man crews would assemble in Portland and pick up their trucks. One crew would drive to the upriver area and pick up all tote locations and drop off two or three totes of ice (depending on demand; one tote of ice is approximately 1,000 lbs). Freezer locations (Snake River dams) would be picked up when necessary. The typical itinerary would be similar to the early season schedule except for two variations. First, on July 9, arrangements were made with a local butcher in Clarkston, WA to handle all the fish carcasses for the rest of the season, thereby eliminating Clarkston from the itinerary. Second, a new field station in Kahlotus, WA was added to the "roster" on July 13 to accommodate the new sport reward site at Windust Park on the Snake River (all of the other sport reward sites brought on line on July 15 were able to be operated from existing field stations). A typical upper river run logged an average of 700 miles (This varied greatly depending on whether stops at Snake River dams were necessary).

The lower river itinerary was quite variable and somewhat delayed because the second truck was not available until Monday afternoon. This crew would stop at as many lower river locations possible that would permit a 9:30 p.m. arrival time at the Goldendale Field Station. The crew would then pick up the totes at the field station as well as receive that evenings catch from the sport reward clerks. Lodging was in Goldendale Monday night. On Tuesday the remaining lower river locations were picked up; typically this would be White Salmon Field Station, The Dalles Dam, and Coverts Landing Sport Reward Site. The lower river run was repeated again on Wednesday night because of the generally high catch rates in the lower river area (particularly from the Goldendale Field Station and Coverts Landing).

#### Fish Distribution

#### Equipment

The following is an inventory of the equipment required to collect and distribute the 1991 catch. This list includes all of the equipment used for both the freezer and the insulated tote systems:

<u>Description</u>	<u># Units</u>	<u>Unit Cost</u>	<u>Total Cost</u>
white totes (21 cubic ft)	210	\$175.00	<b>\$36,500.00</b>
insulated totes (24 cubic ft)	50	365.00	<b>18,250.00</b>
small totes (2 cubic ft)	42	15.00	630.00
freezers (23 cubic ft)	26	380.00	<b>9,880.00</b>
pallet jacks	2	380.00	630.00
plastic bags	188 (120 ct)	5.00	940.00
coolers (40 qt)	6	30.00	180.00
extension cords	30	6.00	180.00
miscellaneous			<u>300.00</u>
			<b>\$67,300.00</b>

Most chest freezers and white totes were taken out of use and put into storage once the transition from freezers to insulated totes was complete (third week of July). These items, particularly the white totes, may become useful again depending on the development of squawfish uses in the future.

#### Vehicle Rental

The following is a summary of vehicle miles and costs for the field season through Aug 31, 1991.

#### Rollins Truck Rental, Portland, Or

Initially, a single vehicle was rented from Rollins with the expectation that a second similar vehicle would be rented if necessary. This truck has a covered box and a gross vehicle weight of 33,000 lbs. The bed is approximately 20 feet long and is equipped with a hydraulic lift gate. The truck is legally capable of hauling about 14,000 lbs of cargo.

The following is a breakdown of the charges associated with renting this vehicle (based on 1,000 / week, 3 days/week, for 1 month):

<u>Charge</u>	<u>Rate</u>	<u>Total (monthly)</u>
Rent	\$245.00 / week	\$980.00
Mileage	0.14 / mile (1,000/week)	560.00
Diesel	10 mpg (1.40/gal)	596.00
P. U. C. pass	10.00/10 days (30 days)	30.00
P. U. C. tax*	4,000 miles/month	<u>186.00</u>
		<b>\$2,792.00</b>

\*tax rates vary among States

On July 1, the second truck was rented from Rollins at the same rental rate. Acquiring this second vehicle doubled our weekly truck rental charges (from 245.00 to 490.00 / week) but other charges remained about the same because the total miles travelled did not change appreciably.

The following is a monthly summary of miles driven and costs incurred through Aug 30, 1991:

Vehicles: 33,000 lb Peterbilt with rail lift  
30,000 lb International with rail lift

<u>Month</u>	<u>Total Miles</u>	<u>Total Cost*</u>
May	2,007 Peterbilt	\$2,049.00
June	7,450 Peterbilt	3,223.00
July	5,717 Peterbilt and Int.	3,366.00
August	2,113 Peterbilt and Int.	<u>1,049.00</u>
	17,277 miles	\$11,456.00

\*Monthly cost does not necessarily correspond well with total miles driven because fuel consumed during a month may be billed the following month.

#### Motor Pool Vehicles

Three vehicles are currently being rented from the OSU Motor Pool. These vehicles are intended for the purpose of commuting employees to and from work sites (principally the truck rental locations in Portland) and hauling fresh fish from the field to the Astoria Seafood Laboratory. Due to a lack of current billings, Motor Pool vehicle charges are shown as the average of the three vehicles from May through August, 1991.

<u>Vehicles</u>	<u>cost</u>	<u>Months</u>	<u>Total Miles*</u>	<u>Total Cost</u>
Ford P/U	\$195.00/mon. .24/mile	May - Aug	4,000	\$1,545.00
Chevy Sedan	166.00/month .29/mile	June - Aug	2,400	978.00
Pontiac Compact	160.00/month .20/mile	June - Aug	<u>1,800</u>	<u>780.00</u>
Totals			8,200	\$3,303.00

Contracted Services

Bonneville Fisheries, Cascade Locks, OR

Bonneville Fisheries became the central receiving area for most of the squawfish carcasses. The insulated totes containing fish were delivered to Bonneville Fisheries and held until the rendering contractor picked up the carcasses. The Bonneville Fisheries employees dumped the totes into the rendering truck, steam cleaned the empty totes, filled them with ice and generally prepared them for the next pickup. Cold storage services were provided in early July.

Monthly Summary of Bonneville Fisheries services (through 21 August 1991):

<u>Month</u>	<u>Service</u>	<u>Volume</u>	<u>Cost</u>	<u>Total Cost</u>
July	ice	24.4 tons	\$35.00/ton	\$854.00
	cold sto.	13,000 lbs	.06/lb	780.00
	labor	62 totes	15.00/tote	930.00
Aug	ice	17.5 tons	"	612.50
	cold st.	none	"	0.00
	<u>labor</u>	<u>20 totes</u>	"	<u>\$300.00</u>
Totals to 21 August:	ice	41.9 tons	"	<b>1,464.75</b>
	cold st.	13,000 lbs	"	780.00
	labor	82 totes	"	<b>1,230.00</b>

Americold Cold Storage; Wallula, WA

Americold is a large cold storage facility in Eastern Washington. This facility provided for the bulk of our cold storage needs and at one point had 64 totes (38,400 lbs) of frozen northern squawfish.

<u>Month</u>	<u>Service</u>	<u>Volume (lbs)*</u>	<u>Cost/100 lbs</u>	<u>Total Cost</u>
June	cold st.	34,100	\$1.35	\$736.75
July	"	39,050	"	390.50
Aug	"	<u>37,400</u>	"	<u>383.00</u>
		110,500		<b>\$1,510.25</b>

\*this is not a total weight, but a combined monthly billing weight

Northwest Ice and Cold Storage, Portland, Or

Northwest Ice and Cold Storage provided the cold storage services for totes from the lower river area.

<u>Month</u>	<u>Service</u>	<u>Volume (lbs)</u>	<u>Cost/100 lbs</u>	<u>Total Cost</u>
May	cold st.	9,600	\$ 1.15	\$110.40
June	"	24,300	"	279.45
July	"	73,900	"	848.85
Aug	"	<u>NA</u>	"	<u>NA</u>
Totals through 7/31/91		107,800		\$1,239.70

\*monthly billing weight, not total weight

Darling / Delaware: scrap and waste renderer in Portland, OR

From July through the end of the field season, Darling Delaware picked up all of the squawfish carcasses from Bonneville Fisheries and hauled them to their Portland plant for rendering (conversion to fishmeal). This service allowed a savings of hundreds of vehicle miles and eliminated the cold storage accumulation problem.

<u>Month</u>	<u>Service</u>	<u>Volume (tons)</u>	<u>Cost/ton</u>	<u>Total Cost</u>
July	Rendering	70.5	\$25.00	\$1,751.25
August	"	<u>25.00</u>	"	<u>625.00</u>
Totals through 8/15/91		95.5		\$2,376.00

Heights Meat Market: meat market and butcher in Clarkston, WA

Heights meat market provided a handling service between the Clarkston area sport reward technicians and a regional rendering service. The fish were delivered directly to the market by the sport reward technicians and deposited into 55 gallon drums. The market owner hauled the full drums into his cold room and held them until the rendering truck arrived. This service saved us thousands of vehicle miles.

<u>Month</u>	<u>Service</u>	<u>10.00/drum</u>	<u># drums</u>	<u>Total Cost</u>
July	rendering labor	"	23	\$230.00
August	"	"	<u>31</u>	<u>310.00</u>
Totals 8/31/91			54	\$540.00

### Space Rental

Three additional field sites had to be rented because the existing sites did not meet the requirements of the tote system (a hard, flat surface to allow pallet jack loading of the full totes and wide enough doors). These three sites were near the existing field stations. Warehouse space in Portland was also rented for overwinter storage of equipment.

<u>Rental Space</u>	<u>Rent/Month</u>	<u>Total for season</u>
Wyers Trading Post, White Salmon, WA	\$175.00	\$525.00
Kahlotus Gas Station, Kahlotus, WA	175.00	525.00
Buddy Eaton's garage. Starbuck, WA	175.00	525.00
Intermountain Supply, Portland, OR	<u>525.00</u>	<u>525.00</u>
Totals through 7/31/91	<b>1,050.00</b>	<b>\$2,100.00</b>

#### Northern Squawfish Utilization Participants

The following is a description of the project participants during the 1991 season:

#### Stoller Fisheries, Spirit Lake, Iowa

Stoller Fisheries is a freshwater fish processor that utilizes "rough" fish to process various products including "kosher" fish. Larry Stoller is very interested in the economic development of northern squawfish from the project. On July 26, Stoller shipped 6 totes (3,600 lbs) of frozen squawfish from Northwest Cold Storage to his facility in Iowa. After performing an analysis and customer taste test, he concluded that northern squawfish flesh exhibits promising food quality characteristics. He also received 64 totes (38,400 lbs) from the Americold facility on August 9, 1991 and performed a complete **fishmeal** analysis. Stoller is particularly interested in the program if a successful commercial harvest gear is developed.

#### Inland Pacific Fisheries, Payette ID

Inland Pacific fisheries is an organic fertilizer manufacturer and was the primary consumer of the 1990 northern squawfish harvest. In 1991, however, IPF has only utilized 6 totes (4,200 lbs) to date. This delivery was made on June 12, 1991.

#### Oregon State University Astoria Seafood Laboratory, Astoria Or

The Seafood Laboratory received weekly deliveries of fresh, iced squawfish beginning the first week of July. These fish were used in a variety of food use experiments (deliveries were not made during the last two weeks of August). The average delivery was an estimated 70 - 90 lbs.

Oregon State University Experimental Fur Farm, Corvallis, OR

The Fur Farm is conducting mink feeding trials using squawfish. To date they have received 5 totes (3,500 lbs.).

Darling / Delaware rendering service, Portland, OR

Darling / Delaware handled most of the squawfish carcasses during the 1991 season. They mix the squawfish with other animal byproducts and sell the resulting meal to the poultry and livestock industry. From the perspective of the this project, Darling / Delaware performed a disposal rather than an economic development function.

Idaho Dept. of Fish and Game, Coeur d'Alene, Idaho

In August, one tote (700 lbs) was picked up from the Americold cold storage facility by Wayne Wakkinen, IDFG biologist. He was interested in experimenting with the squawfish carcasses as grizzly bear bait.

#### Catch Utilization

##### OSU Minced Product Experiments

Fresh unfrozen fish were delivered to the OSU Seafood Laboratory on two different occasions, 12 July and 8 August 1991. Appendices H-3.2 to H-3.4 present composite data from these fresh deliveries and give the weight, length and weight-length relationships. The majority of fresh northern squawfish were over 0.6 kg and measured more than 16 inches. It was noted that the majority of the fish were females, especially the larger sizes.

Proximate analyses were conducted. The protein, lipid, ash, and moisture contents for the washed and unwashed mince are given in Appendix H-3.1. As expected, the percent protein decreased with each wash, but there was less dramatic decrease between the first and second wash. In general, the protein content is a little less than 17% for the unwashed mince. This is reduced to less than 15% during the washing procedures. Lipid content is reduced from 2.78% for the raw mince to under 2% for the washed product. The ash content for the mince decreased more than 50%, from 1.21% to approximately 0.5% after the washing procedure. Moisture content increased during washing from 78% for the mince to close to 84% after the second wash. In general, there were only small differences between the first and second washes. Future work with washed mince will be undertaken with a single wash.

Northern squawfish samples were evaluated for freshness using several methods: DSE, Torrymeter, pH, TBA, microbiological, and stress-strain tests.

DSE results are shown in Appendices H-3.5 through H-3.9. All values decreased with time, but at different rates. Statistical analyses as well as correlations between the different tests have yet to be run. It appears that texture, general appearance, gill color and odor have similar slopes. Eye color defects increased more rapidly over time. In general, the DSE showed that squawfish quality characteristic held up fairly well when stored in ice. For the majority of the properties investigated, it took more than 15 days for the northern squawfish to register greater than a score of one in terms of defects (scale: 0-3 with 0 representing highest quality). If fish can be placed on ice as soon as possible, and delivered to a processing plant within one week, the quality of the fish should remain high.

The Torrymeter readings for the head, middle and tail region shown in Appendices H-3.10 through H-3.12 gave results similar to DSE tests. Average readings started at 15 and decreased approximately 1 unit every four days. The Torrymeter measures the electrical current that passes between two points on the instrument when placed on the fish flesh. As the fish deteriorates, a complex set of cellular reactions occur and the ability to pass the current diminishes. The Torrymeter is a fast, objective measurement that can correspond with more costly and time-consuming biochemical tests. A correlation between the DSE and the Torrymeter run can give the industry a valuable tool in rapidly determining freshness and quality in a new fisheries such as the northern squawfish.

Microbiological and chemical changes that occur in the fish after capture may be indicated by changes in pH level. As Appendix H-3.13 illustrates, very little change was noted during the length of this study and pH would not be a good indicator of freshness.

The TBA test is often used to determine oxidative rancidity during storage. The fattier the fish the more susceptible to oxidation. Northern squawfish is a moderate-to-low fat fish with muscle lipids between 2.5 to 3%. There was a gradual increase, as shown in Appendix H-3.14, in the TBA values of the fish kept on ice, but the changes were small and off-flavors due to rancidity should not be a factor in fresh fish.

Microbiological tests were also performed. Appendix H-3.15 shows the changes in the total plate count of northern squawfish kept on ice for 25 days. There was a gradual increase (with the exception of day 15 and 18) during storage. Above  $10^6$ , products begin to undergo organoleptic changes with regard to taste and odors. By extrapolating a straight line from the graph we can estimate that close to day 15, these changes may occur.

Stress-strain tests were performed to determine changes in gel properties of minced northern squawfish products over time. The values in Appendix H-3.16 demonstrate the gel forming ability of northern squawfish kept on ice for 24 days. Gels were made from raw mince that was produced each day of testing. There was remarkably little drop in the strain value during this period. Strain values are more indicative of gel strength and are critical for forming textured products from minces. Stress decreased more rapidly but the values were still high after 15 days and one can assume that good products can be made.



## Stoller Minced Food Product

The process consisted of removing the fish heads by mechanical header, removing the entrails and washing the fish by mechanical gutting machine, and then introducing the headed and gutted fish to a "Beehive" mechanical deboner. The weight of the heads was determined to be 26.9% of the total weight. **Entrail** weight was 19% of the total weight. The headed and gutted yield of the fish was approximately 54%.

The total weight of food grade minced (mechanically deboned) flesh was 144.2 kgs., which yielded a ratio of finished weight to starting weight of 43.7%. Final yield against headed and gutted weight was approximately 75%.

Processing occurred on 1 August **1991**. Total processing time was 25 minutes. On the basis of this processing time, it is estimated that in full scale production 682 -1136 kgs. per hour could be processed using Stoller Fisheries equipment. Processing time is determinate in the size of fish. Efficiency increases are realized with increasing volumes of fish. Maximum capacity of Stoller Fisheries mechanical deboner is 682 kgs. per hour which would be roughly equal to 1364 kgs. of whole fish per hour.

## Fish Meal

Output from the dryer was observed for a two-hour period to determine if there was any visual disparity between the standard meal produced by Stoller Fisheries and the northern squawfish meal. No observable difference was detected, leading to the preliminary conclusion that northern squawfish would be readily suitable for fish meal processing.

Preliminary results of the second batch of fish meal processing indicate that nutritional content is very similar to carp combined with other species, and is therefore suitable for fish meal processing by this processor. Slight variation from standard fish meal products is detectable in the slightly darker color of the fish meal and fish oil. No unusual odor problems were detected.

Samples of fish oil and meal have been sent by Stoller Fisheries to testing laboratories to determine nutritive content and presence of pesticide-PCB contamination. Appendix H-12.2 and H-12.3 contain comparative information of the nutritive composition of northern squawfish meal and carp fish meal.

## Grizzly Bear Bait

Use of northern squawfish in the Idaho grizzly bear recovery program was successful. The entire 600 lbs. of frozen northern squawfish were used in the experiment. The 10-15 lb. packages of northern squawfish were deemed a convenient size to handle. Radio collars were attached to four out of a total population of nine grizzly bears in the recovery zone (Wakkinen **1991**).

## Liquid Fertilizer

Incorporation of northern squawfish into the liquid fertilizer production line followed much the same pattern as last year. The difference was that a much smaller quantity of northern squawfish was processed in **1991** than in **1990**. The primary reason for this change was equipment difficulties by the

processor which prevented him from accepting full quantities of available fish. All costs of operation were the same as last year, with the exception of labor costs which have risen to \$5-\$7 per hour over \$4-\$5 per hour in 1990. The processor sees the potential for northern squawfish processing as limited to flesh and possibly skin.

#### Mink feed

Feeding experiments are still in progress, and no final results are available at the time of this report. However, preliminary conclusions based on weight gains in the test and control groups, is that the test group (n. squawfish feed) is growing at a rate equal to that of the control group and other mink in the OSU herd. Weight gains to date of the two groups are detailed in Appendix H-5.2. Results of the laboratory analysis of northern squawfish for thiaminase enzyme are not yet available.

#### Shad Bycatch

A report summarizing the results of the assessment of shad utilization possibilities is presented in Appendix H-6.

### Social Issues

Surveys of fisheries participants, staff and enforcement personnel are still in process. Presented below is a summary of information gathered to date of social issues, both negative and positive, associated with the four northern squawfish fisheries conducted in 1991: the tribal commercial **longline** fishery, the dam angling fishery, the sport-reward fishery, and the experimental purse seine fishery.

#### Commercial **Longline** Fishery

Three information sources will be used to construct a complete picture of social issues associated with the tribal commercial **longline** fishery: a survey of commercial fishermen participating in the fishery, a survey of commercial fishery observers, and an informal survey of enforcement personnel of ODFW, WDW, and CRITFC.

A sample of commercial fishermen participating in the commercial **longline** fishery were interviewed by the ODFW and the University of Washington. Of the thirty fishermen participating in the 1991 commercial **longline** fishery, 11 fishermen were interviewed, or 37%. Participation in the commercial **longline** fishery was low in 1991, and many of the questions directed to the fishermen were designed to address the issue of participation.

A number of negative aspects of the fishery were identified by the fishermen. From the fishermen's perspective, the on-board observer system established for the commercial fishery was overly intrusive. It was not understood why the commercial **longline** fishery and not other fisheries would be subject to this level of oversight. Check-in and other paperwork procedures were also seen as overly burdensome. The fishery for northern squawfish also competed with other fishing opportunities for the fishermen, particularly after the start of the salmon season. Weekend fishing conflicts

with sport anglers were identified as an unpleasant aspect of the program fishing schedule. Finally, finances became a problem for some of the fishermen: without a base pay, start-up costs for items such as fuel were a problem and hindered participation.

A telephone survey of the commercial fishery observers is in process, and will be reported on in the final report. Also in the final report will be an assessment of social issues related to the commercial **longline** fishery as seen from the perspective of enforcement personnel.

#### Dam Angling Fishery

Three information sources will be used to assess social issues related to the conduct of the dam angling fishery. The first is telephone interviews with personnel of the U.S. Army Corps of Engineers (**USACE**), **Walla Walla** and **Portland** districts. The second is a summary provided by personnel of **CRITFC**, which provided management oversight of the dam angling project. The third is a summary assessment of **ODFW** personnel employed on the dams.

Personnel of the **Walla Walla** and **Portland** districts of the U.S. Army Corps of Engineers were asked to provide their assessment of dam angling fishery operations in 1991, and to identify any issues related to this fishery. Responses were similar in both **USACE** districts. Dam security and safety, identified in 1990 as potential issues with a dam angling fishery, were deemed not to be a problem. The increased number of people on the dams as a result of fishery operations was also not considered a problem. Isolated negative interactions between personnel were observed, but these were dealt with on an individual basis and were not considered to be a system-wide problem.

The following summary of issues from the perspective of the managers and participants of the dam angling fishery was provided by **CRITFC** personnel. Overall, interactions between anglers working on the dams and the public were positive. Dam anglers often served as a source of information on the predator control program and on other fishery and cultural matters in the **Columbia River Basin**. In the early weeks of the sport-reward fishery, some dam anglers were verbally accosted by members of the public who were concerned that anglers on dams were catching "their" fish. Awareness of and support for the program improved over time in some areas. This resulted in large part from the manner in which the organization and its employees conducted their business in small communities.

In general, cooperation between dam anglers and other personnel was good. Some conflicts of a personal nature arose, but these were dealt with on a case-by-case basis. Close coordination between dam anglers and the **USACE** was required to ensure safety and security considerations were addressed. The most frequent issue arising between anglers and **USACE** personnel were related to clothing policies and the degree to which they should be enforced. In general, dam anglers were welcomed by **USACE** personnel.

A summary assessment of **ODFW** personnel employed on the dams is in process and will be incorporated in the final report.

## Sport-Reward Fishery

Four sources of information will be used to evaluate issues associated with the operation of the sport-reward fishery: a summary of angler comments from the angler surveys; a survey on anglers who did not return to the registration sites with catch and who therefore did not fill out an angler survey; a telephone survey of creel clerks who worked at fishery registration sites; assessments of enforcement personnel of ODFW, WDW, and CRITFC.

Over 10,000 angler surveys were filled out in the 1991 season. Angler comments on the first 1,667 surveys received have been summarized by topic of comment. The summary will be completed when the sport-reward fishery database is completed. The angler survey and voucher form is presented in Appendix H-1.1. Comments to date apply to the following components of the fishery operation: check-in location, registration process, fishery operation, voucher forms, money, and conflicts.

**Checkin** locations were considered to be too few and far between by many anglers. More downriver registration sites nearer to Portland and Vancouver were deemed necessary. In assessing these comments it is important to keep in mind that the sample of angler surveys summarized were from the beginning of the fishing season, in June and July, before the number of registration sites was expanded.

The registration process and the voucher forms associated with it were a cause of concern to some anglers. The registration process was described as too awkward, involving too little flexibility in time of day and location, and too much paperwork. Many suggestions were made to allow self-registration in the predawn hours and at night. Repeated completion of the voucher form (angler survey portion) was burdensome to frequent participants.

Issues associated with fishery operation were perhaps the most common identified. Many anglers felt that the season should be extended, and others felt that the fishing day should be extended, particularly to allow dawn fishing. Suggestions were made to streamline the registration and check-in processes to allow more people to be processed in shorter periods of time. Many anglers requested that more information be provided to them, such as information on the program, identification of northern squawfish as opposed to squawfish look-alikes, successful fishing methods, good bait, and good fishing locations.

Money was the focus of many angler comments. Perhaps the most common was a positive aspect that anglers enjoyed the opportunity to earn money while fishing and while participating in a salmon enhancement effort. Other anglers objected to the difference in per-fish payment between the sport-reward and commercial fisheries, asking for an increase in payment per squawfish. Many anglers objected to the policy of payment for only those fish over 11" in length, feeling that payment should be made for all squawfish landed, even if small fish received a reduced payment.

The second source of information used to assess issues related to the 1991 sport-reward fishery will be a survey on anglers who registered to fish in the reward fishery but did not return to the registration site. Although the sport-reward fishery data base is not yet complete, it appears at this time

that approximately 60% of the 25,000t registrants did not return to register catch of northern squawfish.

We have begun to survey the population of 15,000t nonreturning anglers in coordination with the Washington Department of Wildlife. The population had been sorted by registration site. A systematic 2% sample has been drawn from each registration site population. A short questionnaire has been developed to question anglers about hours fished, number of people in party, catch, and reason for not returning to site. A telephone survey of nonreturning anglers has begun. The questionnaire form is presented in Appendix H-1.2.

The third source of information used is a survey of creel clerks who worked at sport-reward fishery registration sites during **1991**. We designed a survey form to be administered by telephone to the 15 creel clerk supervisors. The questionnaire is presented in Appendix H-1.3. To date, **11** of the 15 have been interviewed about complaints and compliments heard from anglers and their evaluation of several parts of the sport-reward fishery operation.

Angler complaints reported by creel clerk supervisors on boat ramps, fishing, and the registration process form some common themes. Boat ramp complaints were not heard in large number, but when expressed were about crowded boat ramps and ramps in disrepair. Complaints expressed about the fishing experience were all related to concentrations of people in one area: crowding with other anglers on the water and gear damage resulting from crowding; interference from jet skiers, water skiers, and boats passing too fast; litter on the water and on the banks where large numbers of people were fishing. Complaints heard about the registration process included objections to the amount of paperwork and the time required to process it, the requirement of daily registration, fish quality requirements, the repetition of filling out the voucher every day, and having the registration sites in locations which were not good fishing areas.

A summary creel clerk assessment of various components of the sport-reward fishery operation is presented in Table H-9.3, Appendix H-9. From the point of view of the creel clerk supervisors, a majority evaluated the operating hours at sites, the registration process used, and staffing levels as good. However, a third to a half evaluated these same components as only fair or poor. The check-in procedure, data forms, and the data collection process were evaluated as good by a strong majority of the creel clerk supervisors. A slight majority (55%) evaluated equipment at sites as only fair or poor. Detailed recommendations of creel clerk supervisors concerning the above fishery components are listed in Appendix H-9.4.

Phone contact of enforcement personnel of the ODFW, WDW, and CRITFC is in progress. Enforcement representatives are being asked their assessment of any enforcement issues which arose during the conduct of the **1991** sport-reward fishery. Results of this survey will be included in the final report.

#### Experimental Purse Seine Fishery

Three sources of information will be used to assess issues related to the operation of the **1991** experimental purse seine fishery: summaries of National Marine Fisheries Service (NMFS) and UW investigators involved in the two purse

seine research projects, an assessment of dam personnel coordinating with these projects, and an assessment of enforcement personnel.

NMFS and UW researchers reported three major issues related to the operation of the 1991 experimental purse seine fishery: coordination with dam operations, designing operations to minimize the incidental catch of salmonids, and severe river conditions.

The two experimental purse seine operations were designed to operate in close proximity to dams in order to target on concentrations of northern squawfish. Shutting down turbines to allow purse seining to proceed in **forebay** areas requires energy loads and water flow to be shifted to other areas, and therefore depends on a high degree of coordination between the two purse seine projects, the **USACE**, and BPA.

Several restrictions were placed on the experimental fishery to accommodate dam operations and minimize incidental catch of salmonids. The time required to gain authorization for purse seine fishing diminished actual fishing time in the experimental fishery.

High spring river flows created difficult conditions for purse seining, resulting in damaged and lost gear.

#### Regulatory Issues

##### Contaminant Tests

Dioxin test results have not yet been received from the Oregon Department of Environmental Quality. Processing delays at the Environmental Protection Agency Lab in Duluth, Minnesota, have delayed results beyond the expected due date of late April 1991. The prior expectation, based on other contaminant testing of northern squawfish, is that dioxin presence in both flesh and whole fish is likely to be below FDA action levels and will therefore not be an impediment to the development of food uses of northern squawfish. The current estimated delivery date is unknown, although continuing efforts are being made to expedite this analysis. Results will be summarized in Appendix H-12.1.

##### Regulatory Review **Followup**

The first issue identified in the 1990 survey was the need to determine the full-scale effects of northern squawfish fisheries on incidentally caught fish, especially salmon and steelhead. This issues was identified by the NMFS.

To address the concern about incidental catch in the northern squawfish fishery, the following response was taken by the research project. Each project delivers a full accounting of incidental catch on a monthly basis. Monthly reports are sent from ODFW to the Compact. A representative of the NMFS was contacted to determine whether the response taken to date is adequate. Fisheries specific and species specific tabulations on incidental catch were deemed to be an adequate monitoring of incidental catch. Other concerns on general fishery operation were raised at the time of this interview. The first is the problem of too much fishing pressure on river banks in some location and the concern for the riparian zone in general and

aquatic bird habitat in particular. The second concern raised was for the ability of the project to continue to perform adequate evaluation of fishery effects under the large scale operations. A question was raised as to the quality of data received in 1991 under full implementation.

The second issue raised in the 1990 survey was the need for tribal and state fishery managers, governing bodies, and U.S. v. Oregon parties to review plans for commercial fisheries in Zone 6. This issue was identified by the CRITFC.

All commercial fisheries regulations and operating plans are presented to Compact for review. To date, a representative of CRITFC enforcement division was contacted to ask whether this is an adequate procedure. The assessment was that although Compact provides a thorough review of plans, the review is missing an enforcement perspective. Because fishery operations directly affect how enforcement personnel carry out their responsibilities, they would like to be brought into the review process before a fishery is implemented. Enforcement input into fishery design could minimize enforcement difficulties and conflicts after the fishery is implemented. Contact will be made this fall with other CRITFC representatives to gather further information.

The third issue identified was the need for the State of Washington to reclassify northern squawfish as a food fish in order to implement a commercial fishery. To date, information from Washington Department of Wildlife indicates the following: food fish classification may not be a requirement for the implementation of a commercial fishery for northern squawfish. A proposal was being considered to join the WDW and Washington Department of Fisheries, but has since been discarded. Still under consideration is a proposal to require a fishing license to fish for northern squawfish. Further information on efforts in this area will be added as received through further contacts in Washington State government.

The fourth issue identified was the need to define and address regulatory responsibilities and social considerations associated with the development of the commercial fisheries. To address this issue, three sources of information are being collected from tribal interests: a survey of commercial fishermen, interviews with Fisheries Divisions of the Nez Perce, Yakima, Warm Springs, and Umatilla, and questions put to CRITFC commissioners. To date, the survey of commercial fishermen has been completed. Issues identified by the fishermen participating in the 1991 fishery are the following: the need to design the fishery to minimize conflict with other commercial fisheries and with weekend sport fishing, the need to design fishery oversight systems that are less intrusive on fishery operations, more flexibility in the operation of the fishery, and some level of base payment in addition to the per fish payment, in order to cover start-up costs.

The fifth issue identified in the 1990 survey was the need to review and interpret regulations in Washington, Oregon and Idaho for prohibitions against compensation of sport anglers for catch in the context of the sport-reward fishery. Payments for northern squawfish in the context of the predator control fishery has been determined allowable by the Commissioners of both the ODFW and the WDW. The Idaho Department of Fish and Game has yet to be contacted.

The sixth issue identified was the need to examine the effects of issues related to ownership and use of "in-lieu" access sites along the Columbia and Snake Rivers by sport reward anglers. To follow up on this issue, a representative of the USACE was contacted and asked for an assessment of the state of access site "swaps". Twenty-three sites on the Columbia River have been identified as treaty fishing access sites. Twenty-one of these sites are on The Dalles and John Day pools, eight in developed parks. New access sites are in the process of being selected. In the interim, the tribes have agreed for the past two years to allow public use of the access sites. This arrangement is likely to continue until alternative sites are developed.

The final issue identified in the 1990 survey was the need to identify safety and security issues related to access of federal projects by personnel involved in the dam angling fishery. Representatives of the USACE Portland and Walla Walla Districts were contacted to ask what the 1991 experience with safety and security issues had been. In both districts, it was felt that safety and security concerns were adequately addressed through fishery design and rules governing fishery implementation. No outstanding issues remained

#### Tribal Assessment

Information on issues related to the development of fisheries for northern squawfish from the tribal perspective will be added as soon as interviews are completed this fall.

### DISCUSSION

#### Fishery Operation

##### Commercial Fishery

The full evaluation of the commercial longline fishery operations will take place on the basis of cost per unit effort and cost per fish removed as soon as data are complete this fall.

##### Dam Angling Fishery

The full evaluation of the dam angling fishery operations will take place on the basis of cost per unit effort and cost per fish removed by dam, as soon as data are complete this fall.

##### Sport-Reward Fishery

The evaluation of the sport-reward fishery operations will take place on the basis of cost per unit effort and cost per fish removed by site as soon as data are complete this fall.

##### Experimental Purse Seine Fishery

Evaluation of the experimental purse seine fishery is limited to an accounting of costs of operation compared to catch. Difficulties experienced in the operation of the fishery, including short operating times, poor river conditions, and coordination difficulties, make it difficult to assess the cost-effectiveness of this gear. Extrapolation of costs from the experimental



fishery to a potential commercial fishery is not possible due to significant differences in operation.

#### Distribution of Catch

The report is preliminary; nevertheless, from the analysis to date of the **1991** operations, several important conclusions can be reached. These conclusions have strong implications for the design and implementation of the collection and delivery system in the **1992** fishery.

Once the insulated tote system was fully implemented, the collection and delivery network worked quite smoothly. With a few refinements the new insulated tote system will be capable of handling virtually any volume in the future. The following are the major problems encountered during the **1991** season and improvement recommendations:

1. Many of the field stations proved to be poor facilities for the storage and handling of the unexpectedly large volumes of squawfish. Also, many of field stations are in logistically poor locations, particularly in the Columbia River Gorge area (Goldendale and White Salmon).

Recommendation: In the Columbia River region, the fish drop off facilities would be better located in Oregon along Interstate 84 where possible. Such locations would greatly reduce travel time and expensive mileage charges associated with truck rental. These facilities should have concrete floors with drains and doors wide enough to allow the passage of a large tote. Finding such locations in the Gorge area could prove to be difficult.

2. The impressive June and July catch rate seemed to catch everyone by surprise, causing some fish handling problems such as spoilage. First, the freezer network proved to be inadequate for such volumes, and second, the fish handlers were unable to chill such volumes before they were placed in the freezers. This situation worked itself out by mid-season once everyone adopted the tote and ice system.

Recommendation: For the most part, handling problems have been corrected. Next season all the involved agencies should be prepared for the early season harvest by providing adequate fish handling implements (totes, coolers, etc). Should Stoller Fisheries become a major consumer of the squawfish, then fish handling must become a high priority.

3. **In April of 1992**, new federal trucking regulations will come into effect across the country. These regulations will require the fish truckers to be properly licensed (commercial driving licenses) and will effect the number of hours a crew can drive in one day.

Recommendation: License drivers before the season begins. The long driving days of the **1991** season will probably not be

necessary in 1992 because the teams will be prepared for the early season fish volumes.

During the course of the **1991** field season, the squawfish transportation network evolved into an efficient system capable of handling commercial scale quantities of squawfish. Should the **1992** Columbia River Northern Squawfish Control Program operate unchanged from the **1991** season, then the current transportation system should be utilized. However, if major changes in the program be implemented, then the transportation network may need modification. Below are a few possible changes that may affect the transportation network:

1. A greatly expanded program will require an expansion of the current transport system.
2. If a commercial fishery below Bonneville Dam is implemented and is successful, the transport network may require a few accommodating alterations. The necessary changes will not be identifiable until a design is developed for the new fishery.
3. If a commercial processor such as Stoller Fisheries becomes actively involved in squawfish utilization, and hopefully they will, then some changes may be required to accommodate his operation. Again, these changes cannot be identified until a new program is defined.

It is important to note that this draft report is somewhat incomplete since it was written during the end of August and the beginning of September, several weeks before the end of the **1991** field season. Some information that does not appear in this draft will be available in the final report.

First, the increase in scale of operation in **1991** led to the development of a fish collection, storage, and delivery system which approximates systems used in established commercial fish buying operations. For future planning, it is important to note that the choice of appropriate scale and design of the fish handling operation is sensitive to the mix of fisheries and to the overall scale of operation.

Second, expansion of the scale of the collection, storage and delivery system took place very rapidly in **1991** in response to large increases in overall scale of fishery operations. The very short adjustment period afforded for redesigning the scale of operation was in part a function to late decisions made about the scale of fishery operations. Proper planning and design of the **1992** collection, storage and delivery system will depend on an early decision about the scale and mix of fishery operations.

Third, mechanisms need to be developed to maintain quality control over northern squawfish catch. An array of utilization possibilities exist for northern squawfish. Food uses are likely to be the highest value uses with the greatest potential for recovering costs of removal. However, food utilization of northern squawfish is dependent on maintaining a high level of quality control of catch. The oversight system used in **1991** was not sufficient to ensure the collection of food-quality fish.

## Catch Utilization

### OSU Minced Product Experiments

The northern squawfish, when evaluated by standard seafood science practices, keeps well on ice and one can expect a shelf-life of 15 days or more. Only minor changes occur in appearance, odor, and texture. The gel forming properties of the fish, as measured by the torsion test, also hold up well during storage, especially when compared to salt-water fish such as Pacific whiting or pollack. The key to a successful operation in dealing with fresh fish will be at the catch point. The above results will only be achieved if the fish is put in ice immediately after capture. In general, adverse reaction rates, such as bacterial growth and enzymatic reactions, will double with every 10 degree C temperature rise. Consequently, fish that are left on the bank or in the summer heat will deteriorate rapidly and its usefulness for human food will diminish accordingly.

The food potential of northern squawfish was also evaluated. The northern squawfish is a bland tasting whitefish with firm texture. The muscle meat has good eating qualities. The main problem is the amount of bones and the difficulty in obtaining a boneless fillet. One potential for squawfish is the use of minced flesh, both washed and unwashed, in the production of engineered seafoods. There has been a remarkable increase in product development in this area, especially with underutilized species such as northern squawfish. Some of the advantages of these products are the elimination of bones, extended shelf life of minces in frozen storage with addition of cryoprotectants and versatility of the raw material in forming gels and a variety of products.

A key factor in product development, in this area, is ability of the mince to form a gel. The northern squawfish gels for the unwashed mince as reported in figure 15 demonstrate that the squawfish has remarkable strength for forming gels. For comparison in our work with Pacific whiting, we obtained stress and strain data that was 50% in value with what we are seeing with northern squawfish. Moreover, the values remain fairly high over a two week period which is unlike most ocean caught fish. Consequently, we are confident that a high quality product can be obtained from fresh minced fish. We have made some Chinese style fish balls on a very small experimental basis and the results were very good.

There are several experiments underway and several more are planned. Currently, the shelf-life quality of unwashed mince and washed mince in frozen storage is being investigated. Work will also be done in the production of minces from frozen rather than fresh fish. Product development, with organoleptic evaluation, will also be undertaken.

### Stoller Deboned Minced Product

Northern squawfish tested by Stoller Fisheries processed very easily on equipment originally designed to process fresh water suckers and various other small fresh water fish. Although the heads of northern squawfish are different from heads of suckers, the cylindrical bodies are very similar. The cylindrical body shape imposes unique equipment requirements on processing. Most fish processing equipment is designed for fish with more defined body shapes for proper alignment of the fish.

Because of the limited quantity of food grade northern squawfish supplied to Stoller Fisheries, filleting tests were not performed. To fillet northern squawfish by machine, a larger portion of the head would have to be removed. Filleting of northern squawfish may be feasible, but is likely to be a secondary application given the bony nature of the fish.

Processing yields of northern squawfish were very similar to suckers. Standard expectations of processing loss include 30% from heading and **10-15%** from gutting. Entrail loss can be affected by season, depending on the proportion of females in the processing population and the extent to which roe accumulation has proceeded.

Other characteristics of northern squawfish which were noteworthy included its natural odor and coloration. Northern squawfish exhibited a slight natural odor somewhat similar to Fresh Water Drum, although not as pronounced. The odor is not deemed objectionable, and was not carried through to the flesh. The minced flesh of northern squawfish has a coloration slightly lighter than minced suckers and was deemed acceptable. If northern squawfish were to be used to produce minced blocks for portioning and breading it is anticipated that the flesh would have to be washed to remove residual blood. The washing process has a tendency to denature the product and affect its binding capabilities, and also adds additional yield loss. Yield loss results in lower return per unit cost. In general, marketing advantages of rough fish are very sensitive to increases in processing costs.

A sample of 45 lbs. of the minced fish product was sent by Stoller Fisheries to a major East Coast customer. Later samples were sent to two other customers. The frozen minced northern squawfish are now being tested in various product forms. Initial reports indicate a flavor similar to Boston Blue Fish or Fresh Water Pike. Preliminary indications are for market acceptance depending on a price competitive with other fresh water minced fish products.

Stoller Fisheries has concluded on the basis of preliminary tests that marketability of northern squawfish as food fish will be determined not on the basis of product attributes such as color or flavor but instead on price. For northern squawfish to find markets as food products, it must be bought and processed at prices competitive with substitutes.

#### Fish Meal

Preliminary analysis indicates that northern squawfish are suitable for processing into fish meal, and that the nutritive content of northern squawfish fish meal is very similar to meal made from carp. Northern squawfish may therefore be considered a substitute for carp in the production of fish meal from fresh water rough fish. Unlike 1990 experiments with the introduction of northern squawfish into a marine fish meal processing line, no unusual or offensive odor is produced by northern squawfish in this process. Fuller analysis of the large-scale fish meal processing with northern squawfish will be forthcoming in fall **1991**.

Processing results to date of both deboned minced fish and fish meal products indicate that commercial processing of northern squawfish is feasible. Feasible processing in this context is defined as profitable

production using existing equipment which allows for the disposal of fish waste in a profitable - or at least no loss - manner.

### Grizzly Bear Bait

The Idaho grizzly bear recovery program is an ongoing research effort. The successful use of northern squawfish in this program has created interest on the part of the Idaho Department of Fish and Game in continued use. Northern squawfish are needed in August, when the trapping efforts are undertaken. The optimal packaging form for this use is in frozen **10-15 lb.** packages.

### Liquid Fertilizer

Trial runs of northern squawfish in a liquid fertilizer production line were successful in both 1990 and 1991. This product form is a feasible outlet for supplies of northern squawfish on a technical basis, but since full-scale processing has not taken place it is not clear whether liquid fertilizer processing is an economically feasible outlet. The estimated price the processor would be willing to pay was **\$.02-.05** per pound. The processor was not willing to estimate a comparable price in 1991.

### Mink Feed

At the end of the mink feeding experiments in late fall 1991, final animal size, detailed pelt color, and fur characteristics will be statistically analyzed to determine the effects of feeding northern squawfish as a component of mink rations.

### Shad **Bycatch**

A discussion of the potential for utilization of shad **bycatch** is contained in a separate report in Appendix H-6.

## Social Issues

As noted above, several data sources used to assess social issues related to the operation of the four fisheries are still being compiled. The following discussion is based on results to date. Further information from completed surveys will be added to the final report.

### Commercial Fishery

The commercial **longline** fishery was plagued by low levels of participation in 1991. On the basis of what is known to date, it is clear that several factors contributed to the low participation levels in this fishery. The registration process and the level of oversight was considered obtrusive by fishermen. Northern squawfish fishing competed with other fishing activities. Fishermen felt that weekend fishing created unwelcome conflicts with sport fishermen. Fishing for per-fish payment only meant that start-up costs were difficult for some fishermen to cover. These difficulties suggest that the commercial **longline** fishery, if continued to be operated as it has been to date, will continue to be a fragile operation. Planning around some of the more objectionable characteristics of the fishery may provide the opportunity to continue this fishery on a larger scale in 1992.

Further information about social issues associated with the commercial fishery will be added when the surveys of commercial fishery observers and enforcement personnel are complete.

#### Dam Angling Fishery

To date, information on issues associated with the dam angling fishery suggests that the fishery operated in good cooperation with other agency personnel and with the public. No fishery-wide problems to avoid in 1992 planning were identified.

Further information about issues related to this fishery will be added when the summary from ODFW personnel has been completed.

#### Sport-Reward Fishery

Information received to date from the creel clerk supervisors and some angler surveys suggest a number of areas in which the **1991** experience can be used for **1992** planning. Several suggestions have been made for streamlining the registration, data collection, and check-in process. Staffing levels and equipment needs have also been assessed. Advance planning for the scale of operation in **1992** should enable the design of a system which takes advantage of recommendations made this year.

Further information will be added when the nonreturning angler survey is complete, and when the angler data base is received.

#### Experimental Purse Seine Fishery

Poor river conditions and difficulties in coordinating operations with dam operations and incidental catch concerns hindered the operations of the purse seine fisheries in **1991**. Low catches of northern squawfish per unit operating cost were a further attribute. Relatively **high** catches of shad in this fishery indicate a continuing need to identify **utilization** possibilities for this species.

#### Tribal Fishery Development

Information will be added on issues related to the development of tribal fisheries for northern squawfish when interviews are completed this fall.

### Regulatory Issues

#### Contaminant Tests

Planning for long term utilization possibilities for northern squawfish rests on sufficiently low levels of dioxin contamination in squawfish flesh. The results of tests for the presence of dioxin should be completed this fall.

#### Regulatory Review **Followup**

Issues identified in the **1990** survey are being addressed through a number of channels. To date, project responses address these issues appear to be adequate. Some new issues have arisen in **1991**. Further identification of these issues will continue throughout the fall as surveys of all interested

parties are completed. Perhaps the most indefinite unresolved issues are the statutory issues related to the long term operation of fisheries for northern squawfish and constraints on commercial operations, and the long term access to river sites. Future endangered species actions also introduce some uncertainty into the planning for long term fisheries on northern squawfish, although at present the monitoring system established for incidental catch has been deemed adequate.

#### Tribal Assessment

Information will be added on tribal assessments of issues related to the development of fisheries for northern squawfish when interviews are completed this fall.

## REFERENCES

- Association of Official Analytical Chemists. 1990. Official Methods of Analysis, 15th edition. Washington, D. C.
- Hanna, S. 1990. Feasibility of Commercial and Bounty Fisheries for Northern Squawfish. Pages 79 - 141 in A.A. Nigro, ed., Developing a predation index and evaluating ways to reduce **salmonid** losses to predation in the Columbia River Basin. 1990 Final Report. Contract **DE-A179-88BP92122**, Bonneville Power Administration, Portland.
- Hanna, S. and J. Pampush. 1991. Economic, Social and Legal Feasibility of Commercial and Bounty Fisheries for Northern Squawfish. Report B in A. A. Nigro, ed., Developing a predation index and evaluating ways to reduce **salmonid** losses to predation in the Columbia River Basin. 1991 Final Report. Contract **DE-A179-88BP92122**, Bonneville Power Administration, Portland.
- Jason, A. C. and Lees, A. 1971. Estimation of fish freshness by dielectric measurement. Department of Trade and Industry Report No. 71/7. Torry Research Station, Aberdeen.
- Lanier, T. C., Hamann, D. D. and Wu, M. C. 1985. Development of methods for quality and functionality assessment of surimi and minced fish to be used in gel type food products. Report to the Alaskan Development Foundation, Anchorage, AK.
- Wakkinen, W. 1991. Personal Communication. Idaho Department of Fish and Game, Couer d'Alene, Idaho.
- Woyewoda, A. D. and Shaw, S. J. 1984. Operational Groundfish Grading and Laboratory Methods Guide. Canadian Institute of Fisheries Technology, Halifax, N. S.
- Yu, T. C. and Sinnhuber, R. 1957. 2-thiobarbituric acid method for measurement of rancidity in fishery products. Food Technology **11:104**.





APPENDIX H-1

Sport-Reward Fishery Data Forms



Appendix H-1.1. Sport-Reward Fishery Survey Form

Members of a **single household fishing and submitting voucher together**: Main angler in household answer questions for entire household. **Members of separate households fishing individually or together, submitting separate vouchers**: Each registered angler should answer questions for him/her self. (If group expenditures made for #7,8,9, enter amount of your individual expenditure only.)

**PLEASE FILL IN OR CIRCLE THE APPROPRIATE ANSWER**

- |   |  |
|---|--|
| <p>1. Number of anglers in your party:<br/>PEOPLE</p> <p>2. Number of hours spent fishing for squawfish: HRS (PER PERSON)</p> <p>3. Miles traveled (one way) to fish at this reservoir:<br/>         1. &lt;20                    4. 60-79<br/>         2. 20-39                   5. 80-99<br/>         3. 40-59                   6. 100 or more</p> <p>4. If staying away from home, number of days you stayed in the area this trip:<br/>         1. &lt;1                        5. 4<br/>         2. 1                            6. 5<br/>         3. 2                            7. &gt;5<br/>         4. 3</p> <p>5. If you stayed overnight, type of accomodation:<br/>         1. MOTEL<br/>         2. STATE PARK<br/>         3. NATIONAL PARK CAMPGROUND<br/>         4. PRIVATE CAMPGROUND<br/>         5. FRIEND OR RELATIVE<br/>         6. OTHER (please specify)<br/>         _____</p> <p>6. Total amount spent on accomodations:<br/>         _____</p> <p>7. Approximate amount spent to purchase food on this trip:<br/>         1. RESTAURANT!% \$ _____<br/>         2. GROCERY STORE: \$ _____<br/>         3. OTHER (please specify)<br/>         _____</p> <p>8. Other expenditures in the area:<br/>         1. GAS: \$ _____<br/>         2. FISHING SUPPLIES: \$ _____<br/>         3. BAIT: \$ _____<br/>         4. OTHER (please specify):<br/>         \$ _____</p> | <p>9. Primary method you/(your party) used: (circle one)<br/>         1. BOAT, ANCHORED<br/>         2. BOAT, DRIFTING<br/>         3. BOAT, TROLLING<br/>         4. SHORE<br/>         5. ANGLING, SURFACE<br/>         6. ANGLING, BOTTOM<br/>         7. OTHER (please specify): _____</p> <p>10. Primary bait or tackle you/(your party) used: (circle one)<br/>         1. WORMS<br/>         2. CUT FISH BAIT<br/>         3. SPINNERS<br/>         4. SPOONS<br/>         5. FLATFISH<br/>         6. SURFACE PLUGS<br/>         7. HOOK AND LINE WITH 1 HOOK<br/>         8. HOOK AND LINE WITH &gt;1 HOOK<br/>         9. OTHER (please specify): _____</p> <p>11. Approximate purchase price of any tackle used:<br/>         \$ _____</p> <p>12. Primary reason for this trip: (circle one)<br/>         1. SQUAWFISH<br/>         2. OTHER FISH<br/>         3. COMBINATION OF OTHER FISH/ SQUAWFISH<br/>         4. NONFISHING ACTIVITY<br/>         5. OTHER (please specify)<br/>         _____</p> <p>13. Have you fished for squawfish before?<br/>         1. YES<br/>         2. NO</p> <p>14. Have you ever caught squawfish while fishing for another species?<br/>         1. YES, OFTEN<br/>         2. YES, OCCASIONALLY<br/>         3. NO</p> |
|---|--|

15. What did you most often do with the squawfish you caught before? (Circle one)
1. ATE
  2. GAVE AWAY FOR OTHERS TO EAT
  3. FED TO ANIMALS
  4. USED AS FERTILIZER
  5. THREW AWAY
  6. RELEASED BACK TO RIVER
  7. OTHER (please specify): \_\_\_\_\_
16. Have you ever eaten squawfish in any form?
1. YES
  2. NO
17. If answer to #16 is yes, how would you rate squawfish quality (taste and texture)?
1. VERY SATISFACTORY
  2. SATISFACTORY
  3. UNSATISFACTORY
18. How many fishing trips do you usually make per year?
- |          |          |
|----------|----------|
| 1. 0     | 5. 16-20 |
| 2. 1-5   | 6. 21-25 |
| 3. 6-10  | 7. >25   |
| 4. 11-15 |          |
19. Of these trips, number in this reservoir:
- |          |          |
|----------|----------|
| 1. 0     | 5. 16-20 |
| 2. 1-5   | 6. 21-25 |
| 3. 6-10  | 7. >25   |
| 4. 11-15 |          |
20. Years you have fished at this reservoir:
- |        |        |
|--------|--------|
| 1. C1  | 3. 4-5 |
| 2. 1-3 | 4. >5  |
21. State of residence:
1. OREGON
  2. WASHINGTON
  3. IDAHO
  4. OTHER (please specify): \_\_\_\_\_
22. Age:
- |          |          |
|----------|----------|
| 1. 14-20 | 5. 51-60 |
| 2. 21-30 | 6. 61-70 |
| 3. 31-40 | 7. >70   |
| 4. 41-50 |          |
23. Any problems encountered while fishing:
1. ON BOAT RAMP (please specify):-  
\_\_\_\_\_  
\_\_\_\_\_
  2. ON WATER (please specify): \_\_\_\_\_  
\_\_\_\_\_  
\_\_\_\_\_
24. How did you hear about the squawfish bounty program?
1. NEWSPAPER
  2. RADIO
  3. TV
  4. WORD OF MOUTH
  5. STATE FISHERY AGENCY
  6. OTHER (please specify)  
\_\_\_\_\_
25. What is your opinion of this fishing experience?
1. SATISFIED
  2. INDIFFERENT
  3. NOT SATISFIED
26. COMMENTS:  
\_\_\_\_\_  
\_\_\_\_\_  
\_\_\_\_\_  
\_\_\_\_\_

THANK YOU FOR YOUR HELP AND TIME.



Appendix H-1.2. Sport-Reward Fishery Nonreturning Angler Survey Form



**Telephone Questionnaire for Non-returning Anglers  
Northern Squawfish Sport-Reward Fishery 1991**

Angler Name: \_\_\_\_\_ Interviewer Name: \_\_\_\_\_ Date: \_\_\_\_\_

Our records show that you registered to fish for northern squawfish at \_\_\_\_\_ (location) but did not return to the site to register your catch. We would like to ask you a few follow-up questions about your fishing experience to help us identify any areas of needed improvement in our program.

1. How many hours did you fish in total that day? \_\_\_\_\_ HRS.
2. Of the total hours you spent fishing, how many hours did you fish for northern squawfish?  
\_\_\_\_\_ HRS.
3. How many anglers fished using this registration form? \_\_\_\_\_
4. What fishing method(s) did you use to fish for northern squawfish?  
\_\_\_\_\_

5. Did you catch any northern squawfish?

Y ES                      NO - - - -

If yes: Number <11" \_\_\_\_\_ Number >11" \_\_\_\_\_

6. Did you catch any species other than northern squawfish?

Y ES                      NO \_\_\_\_\_

Name species: \_\_\_\_\_

7. Reason for not returning to site:  
\_\_\_\_\_

8. Will you continue to fish in the sport-reward fishery for northern squawfish?

YES \_\_\_\_\_ NO \_\_\_\_\_

Reason: \_\_\_\_\_

Thank you for your time.

Appendix H-1.3. Sport-Reward Fishery Creel Clerk Survey Form

**Telephone Questionnaire for Creel Clerk Evaluation  
of the 1991 Sport-Reward Fishery**

Interview date: \_\_\_\_\_

We would like your help in evaluating the operation and conduct of the sport-reward fishery this summer. Your answers will be confidential. Information from this survey **will** be reported in summary form only. Individual respondents will not be identified.

1. Please tell us how many complaints in the following categories you heard from anglers.

	<b>Many</b>	<b>Some</b>	<b>Few</b>	<b>None</b>	<b>NA</b>
<b><u>Boat Ramps</u></b>					
overcrowding on boat ramps	___	___	___	___	___
size of boat ramps					
time waiting to launch			___	___	___
other (specify)					
_____	___	___	___	___	___
_____					
<b><u>Fishing</u></b>					
crowding with other anglers	___	___	___		
crowding with commercial fishermen		___	___	___	
gear damage from crowding with anglers	___	___			___
gear damage from crowding with <b>comm.</b> fishr.			___		___
boats passing too fast	___				
jet skiers					
water skiers				___	
litter in water	___				
litter on banks			___		
other (specify)					
_____		___		___	
_____					
<b><u>Registration and Check-In</u></b>					
registration processing time	___	___	___	___	___
registration processing paperwork	___	___	___		
problems with other anglers					
check-in time					
check-in paperwork	___	___	___	___	___
fish quality requirements	___	___	___	___	___
other (specify)					
_____	___	___	___	___	___
_____		___	___	___	___

2. We would like your evaluation of several parts of the sport-reward fishery operation, and any recommendations you have for change.

a. operating hours: good - fair - poor -

recommendations: \_\_\_\_\_  
\_\_\_\_\_

b. registration process: good \_\_\_ fair \_\_\_ poor \_\_\_

recommendations: \_\_\_\_\_  
\_\_\_\_\_

c. fish check-in process: good \_\_\_ fair p\_o\_o\_r \_\_\_

recommendations: \_\_\_\_\_  
\_\_\_\_\_

d. data forms: good \_\_\_ fair p\_o\_o\_r \_ \_

recommendations: \_\_\_\_\_  
\_\_\_\_\_

e. data collection process: good \_\_\_ fair \_\_\_ poor \_\_\_

recommendations: \_\_\_\_\_  
\_\_\_\_\_

f. staffing: good \_\_\_ fair \_\_\_ poor \_\_\_

recommendations: \_\_\_\_\_  
\_\_\_\_\_

g. equipment: good \_\_\_ fair \_\_\_ poor \_\_\_

recommendations: \_\_\_\_\_  
\_\_\_\_\_

h. interaction with public: good \_\_\_ fair \_\_\_ poor \_\_\_

recommendations: \_\_\_\_\_

\_\_\_\_\_

i. station security: good \_\_\_ fair p o o r \_ \_

recommendations: \_\_\_\_\_

\_\_\_\_\_

j. other recommendations: \_\_\_\_\_

\_\_\_\_\_

\_\_\_\_\_

\_\_\_\_\_

3. Did you or your crew hear any complaints about the sport-reward fishery from townspeople near your site? YES \_\_\_ NO \_\_\_

If yes, please specify:

\_\_\_\_\_

\_\_\_\_\_

\_\_\_\_\_

4. Did you or your crew hear compliments about the operation of the sport-reward fishery? YES \_\_\_ NO \_\_\_ If yes, please specify:

\_\_\_\_\_

\_\_\_\_\_

\_\_\_\_\_

\_\_\_\_\_

THANK YOU FOR YOUR HELP.

APPENDIX H-2.

Experimental Purse Seine Fishery Logbook Form

**NORTHERN SQUAWFISH PURSE SEINE FISHERY DAILY LOG**

Date: \_\_\_/\_\_\_/\_\_\_

Name: \_\_\_\_\_

Day Start Time:     hh mm  
                  \_\_\_:\_\_\_

Day End Time:     hh mm  
                  \_\_\_:\_\_\_

N Crew (excluding captain):

N S e t s :

**Expenditures:**

	<u>Quantity</u>	<u>Total Cost</u>
Fuel	_____	_____
Oil	_____	_____
Ice	_____	_____
Bait	_____	_____
Gear Repair		_____
Engine Maintenance		_____
Crew Payment (total)		_____
Food		_____
Misc. Supplies (specify)		_____
Other (specify)		_____
Other (specify)		_____
Other (specify)		_____

**Crew Pavment Formula:** (If wage, specify wage. If crew share, specify how calculated.)

---



---

For each set, I will need the following info:

Start Time: : \_\_\_\_\_ hh mm      End Time: : \_\_\_\_\_ hh mm

Northern Squawfish Catch: (number)

Incidental Catch:

Species 1: \_\_\_\_\_ N u m b e r :  
Species 2: \_\_\_\_\_ N u m b e r :  
Species 3: \_\_\_\_\_ N u m b e r :  
Species 4: \_\_\_\_\_ N u m b e r :  
Species 5: \_\_\_\_\_ N u m b e r :

Gear Performance Comments: \_\_\_\_\_  
\_\_\_\_\_  
\_\_\_\_\_  
\_\_\_\_\_  
\_\_\_\_\_

If gear damage, time spent repairing gear: \_\_\_\_\_ hh mm

Gear specification information: mesh size, other variables.





APPENDIX H-3.

OSU Seafood Laboratory Experiments



Appendix H-3.1. Proximate Analysis of N. Squawfish Mince

Table 1. Proximate Analysis of Unwashed and Washed Mince from Northern Squawfish

	Protein		Moisture		Lipid		Ash	
	Ave %	SD	Ave %	SD	Ave %	SD	Ave %	SD
Raw Mince	16.65	.171	78.47	.534	2.78	0.31	1.12	.0081
Mince First Wash	14.41	.267	83.07	.520	1.99	.056	.51	.0126
Mince Second Wash	14.06	.098	83.78	.450	1.74	.019	.41	.0153

## Appendix H-3.2. Weight Distribution of Squawfish

FIGURE 1

# Weight Distribution of Squawfish

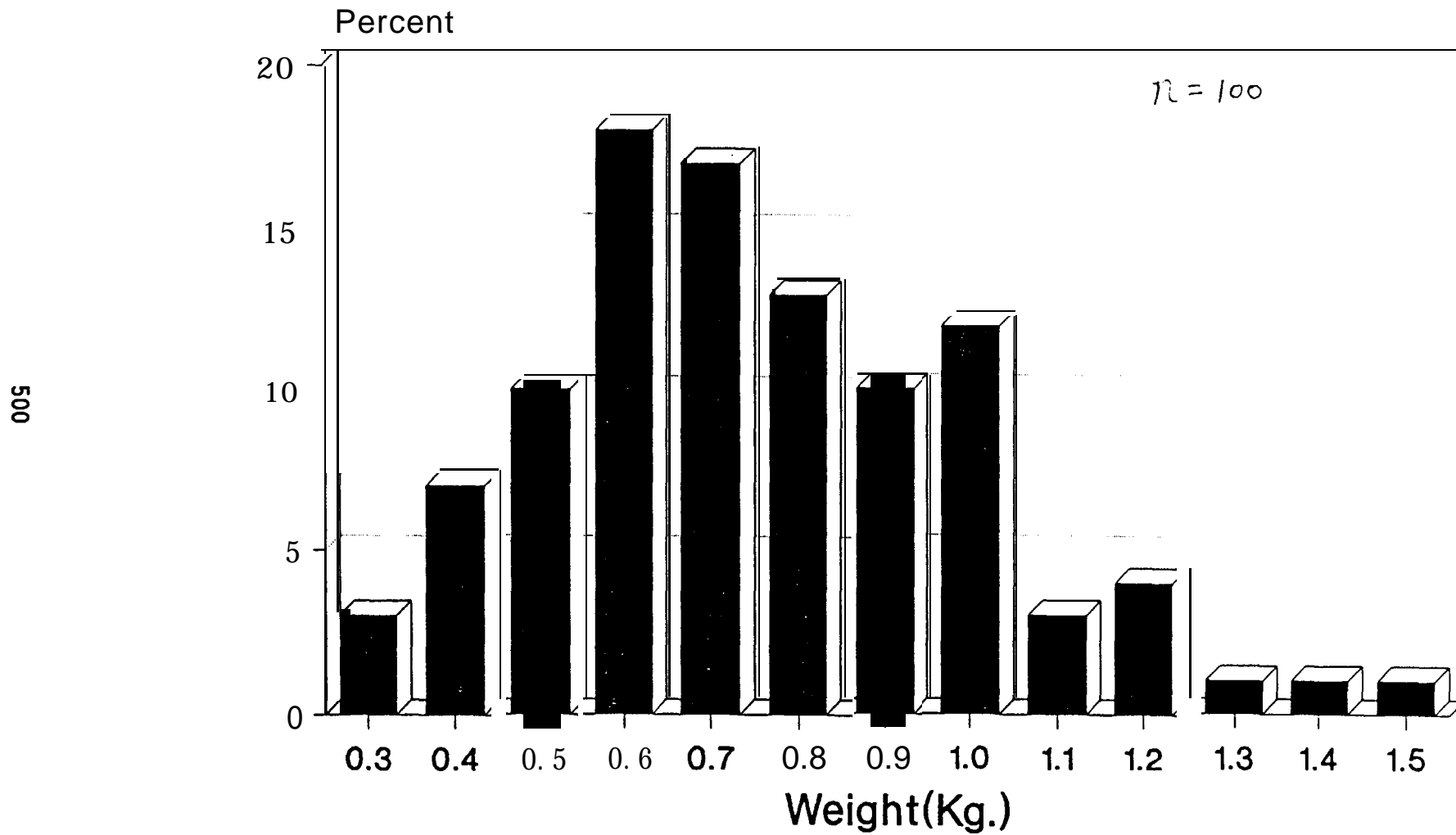

### Appendix H-3.3. Length Distribution of Squawfish



FIGURE 2

# Length Distribution of Squawfish

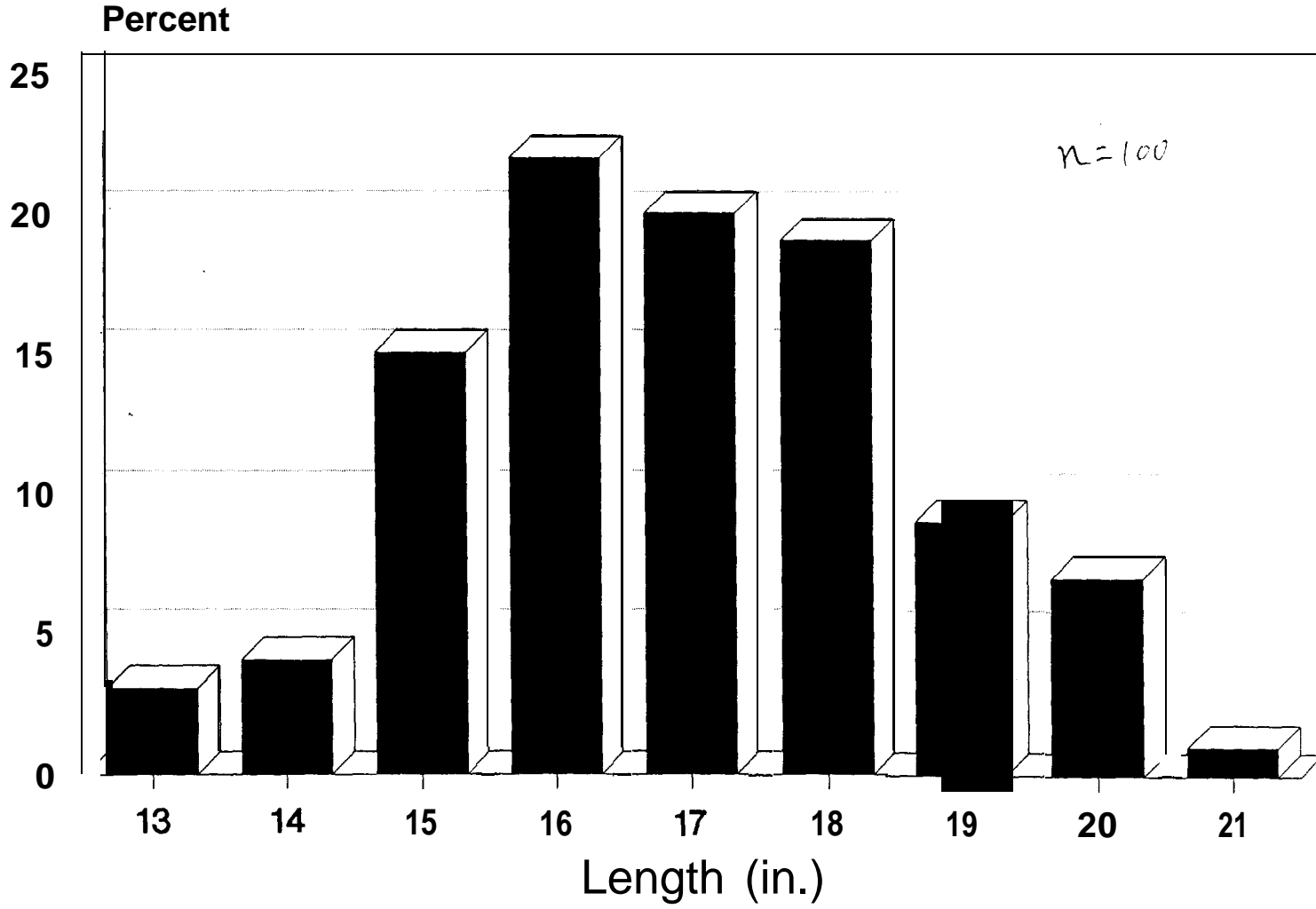

Appendix H-3.4. Weight/Length Relationship of Squawfish

FIGURE 3

# Weight/Length Relationship of S

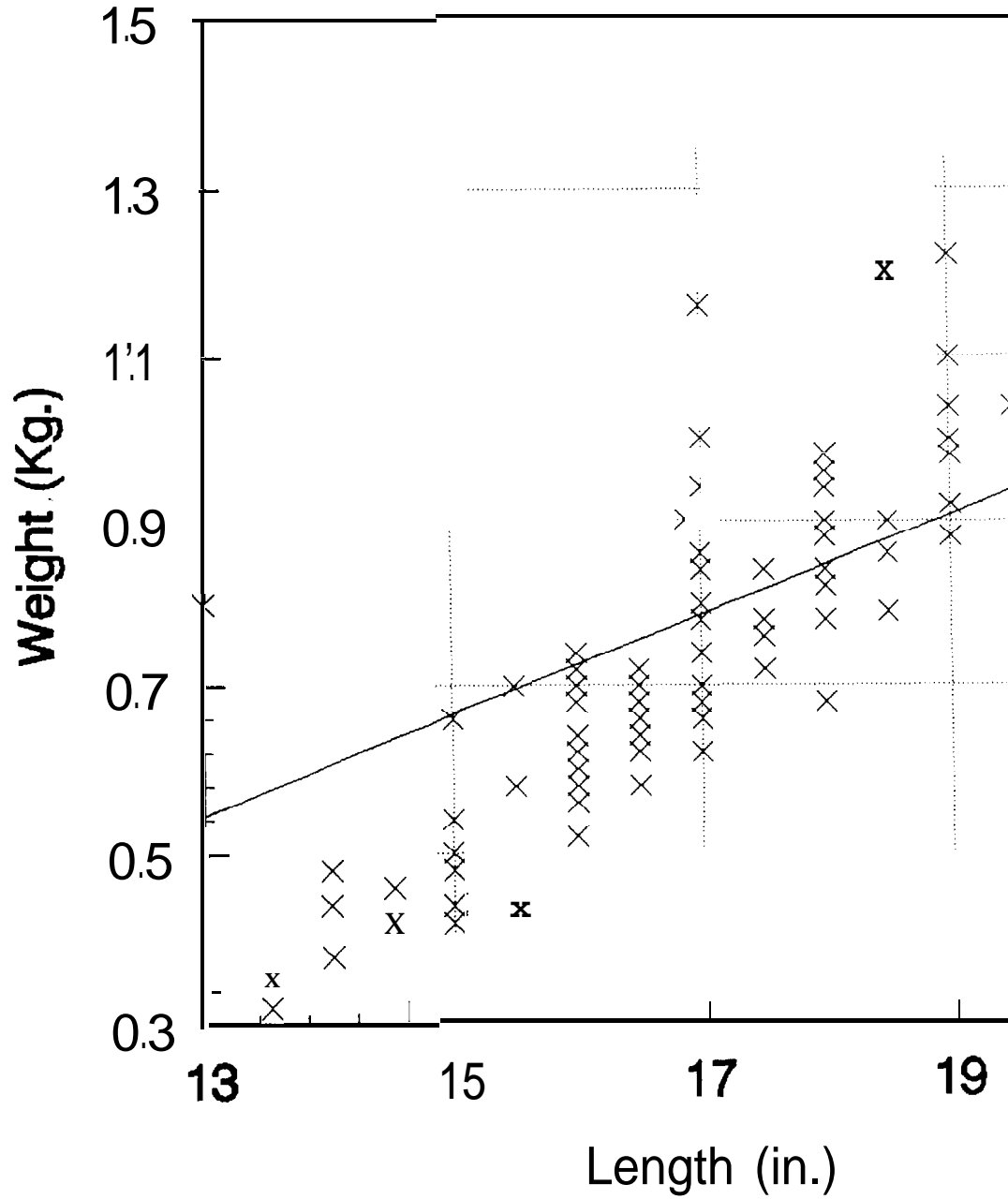

Appendix H-3.5. Gill Color with Days on Ice

FIGURE 4

# Gill Color

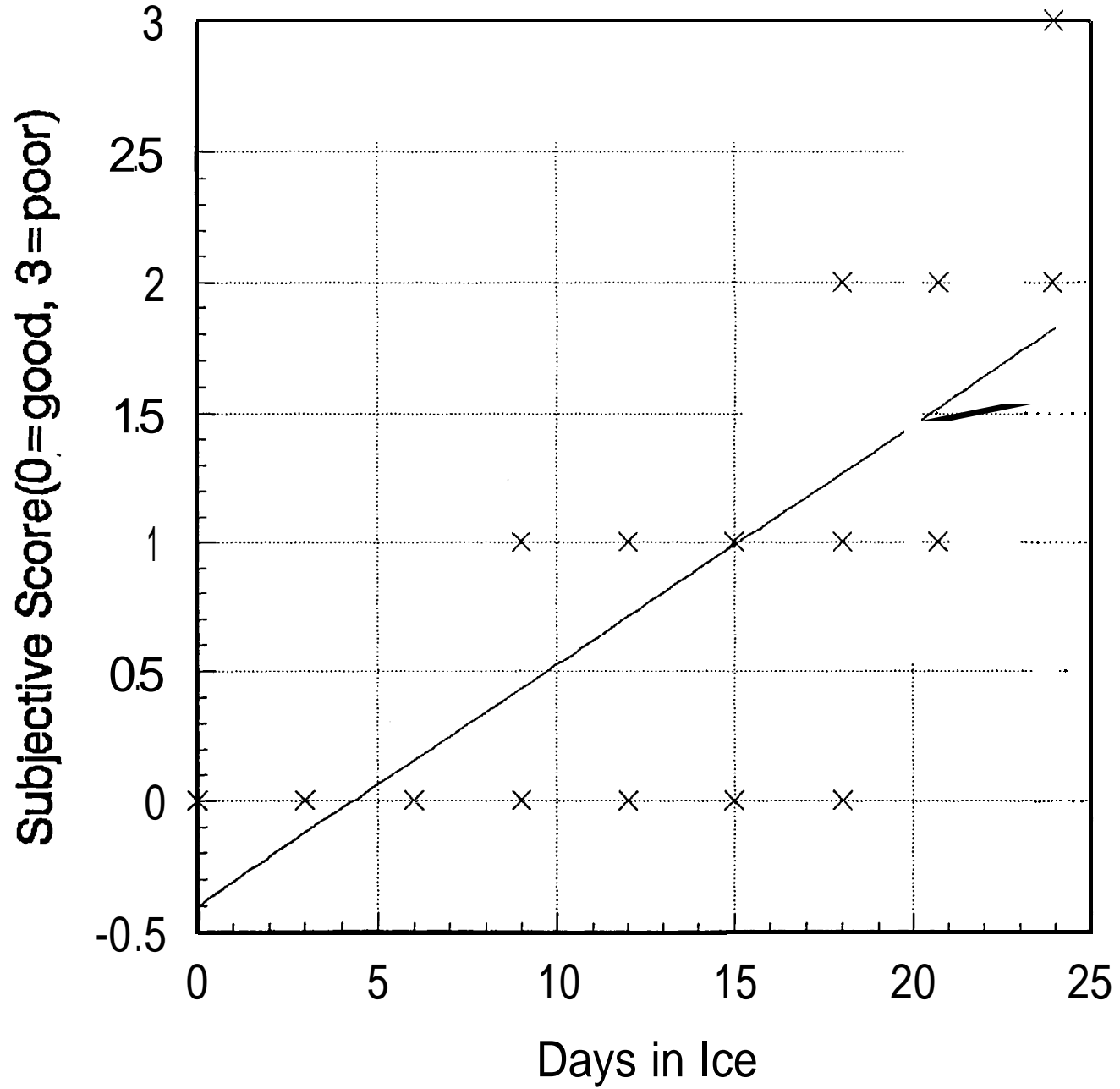

Appendix H-3.6. Gill Odor with Days on Ice

FIGURE 5

# Gill Odor

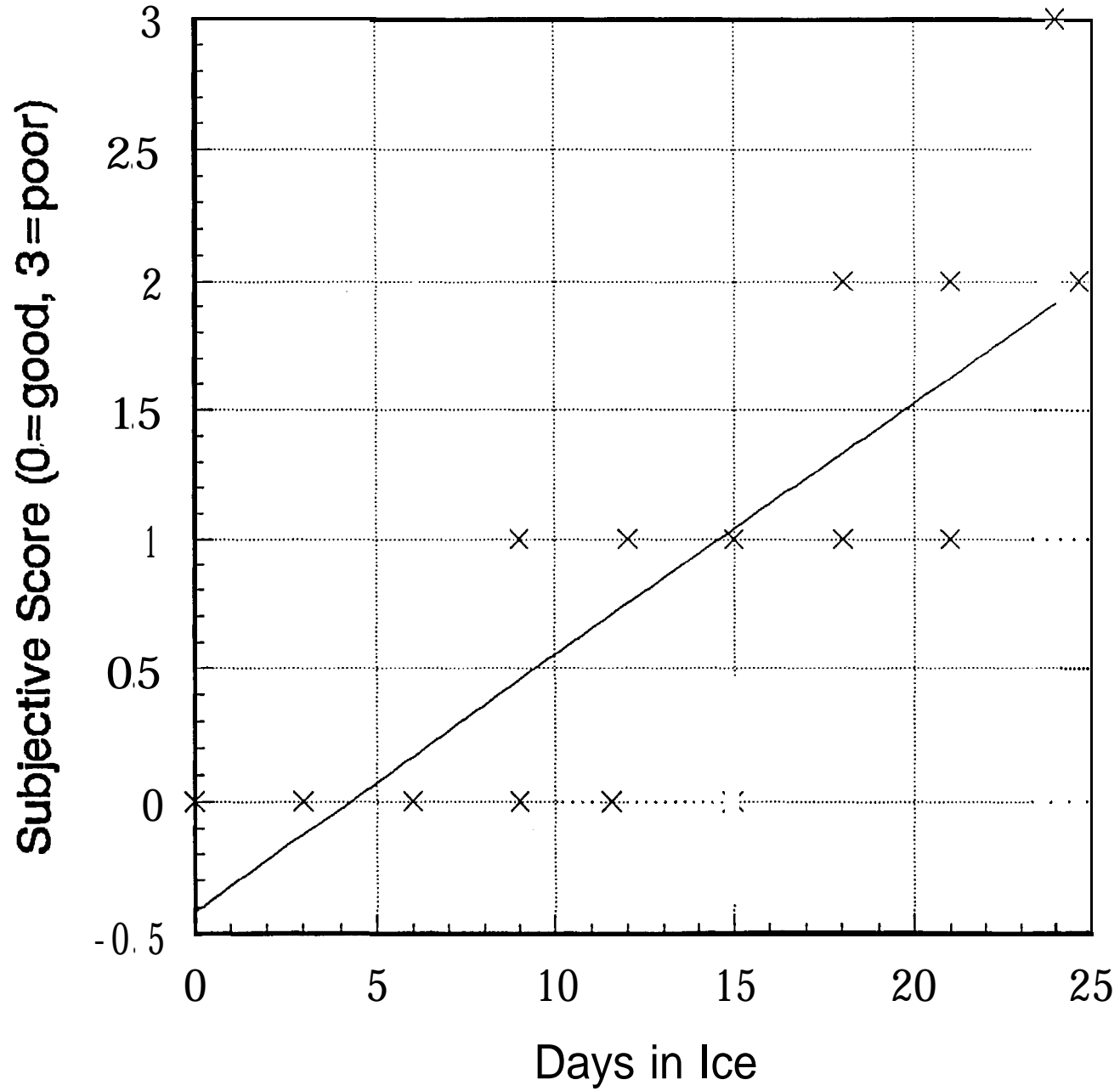

Appendix H-3.7. Eye Color with Days on Ice



FIGURE 6

# Eye Color

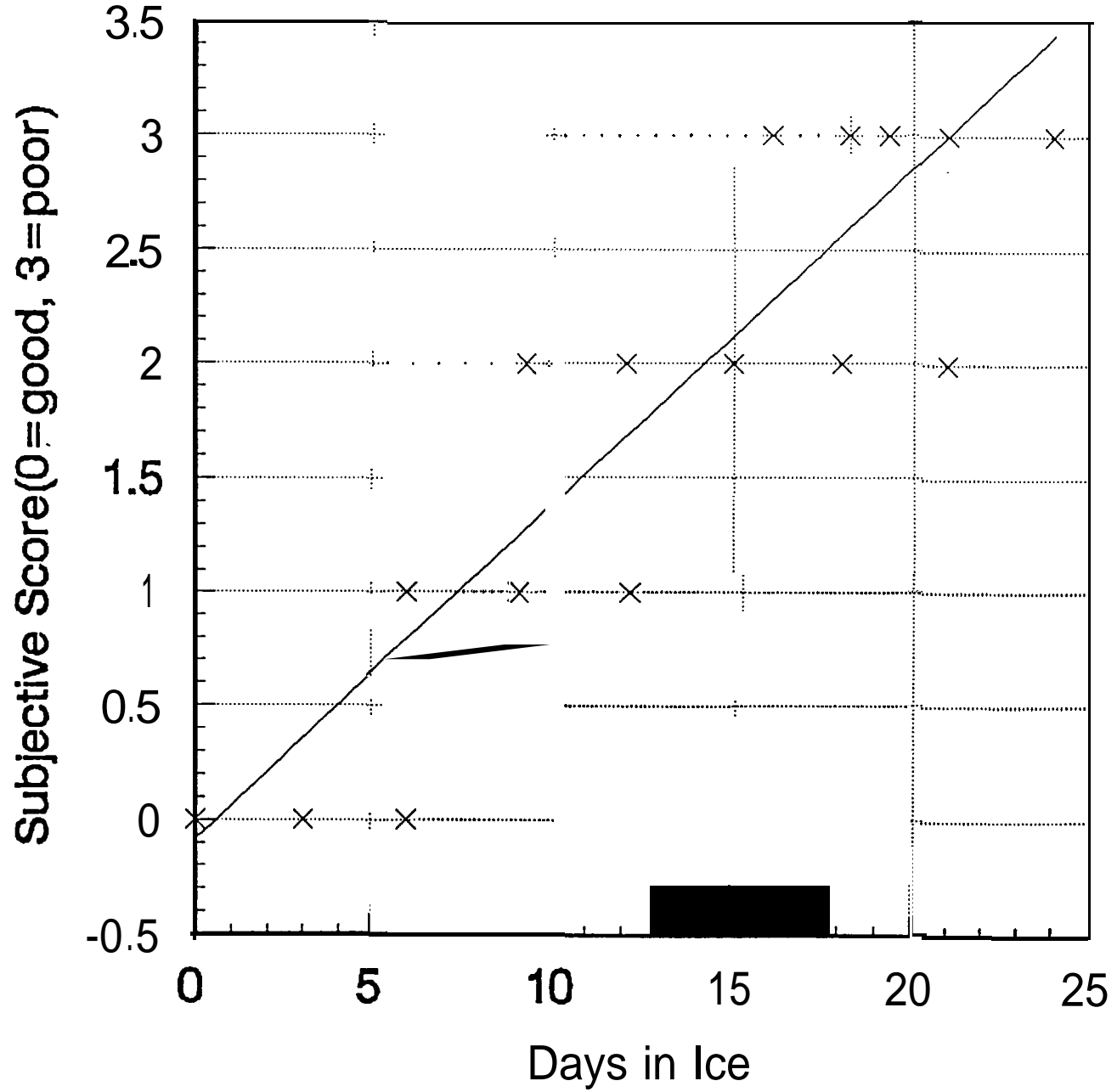

Appendix H-3.8. Texture with Days on Ice

FIGURE 7

# Texture

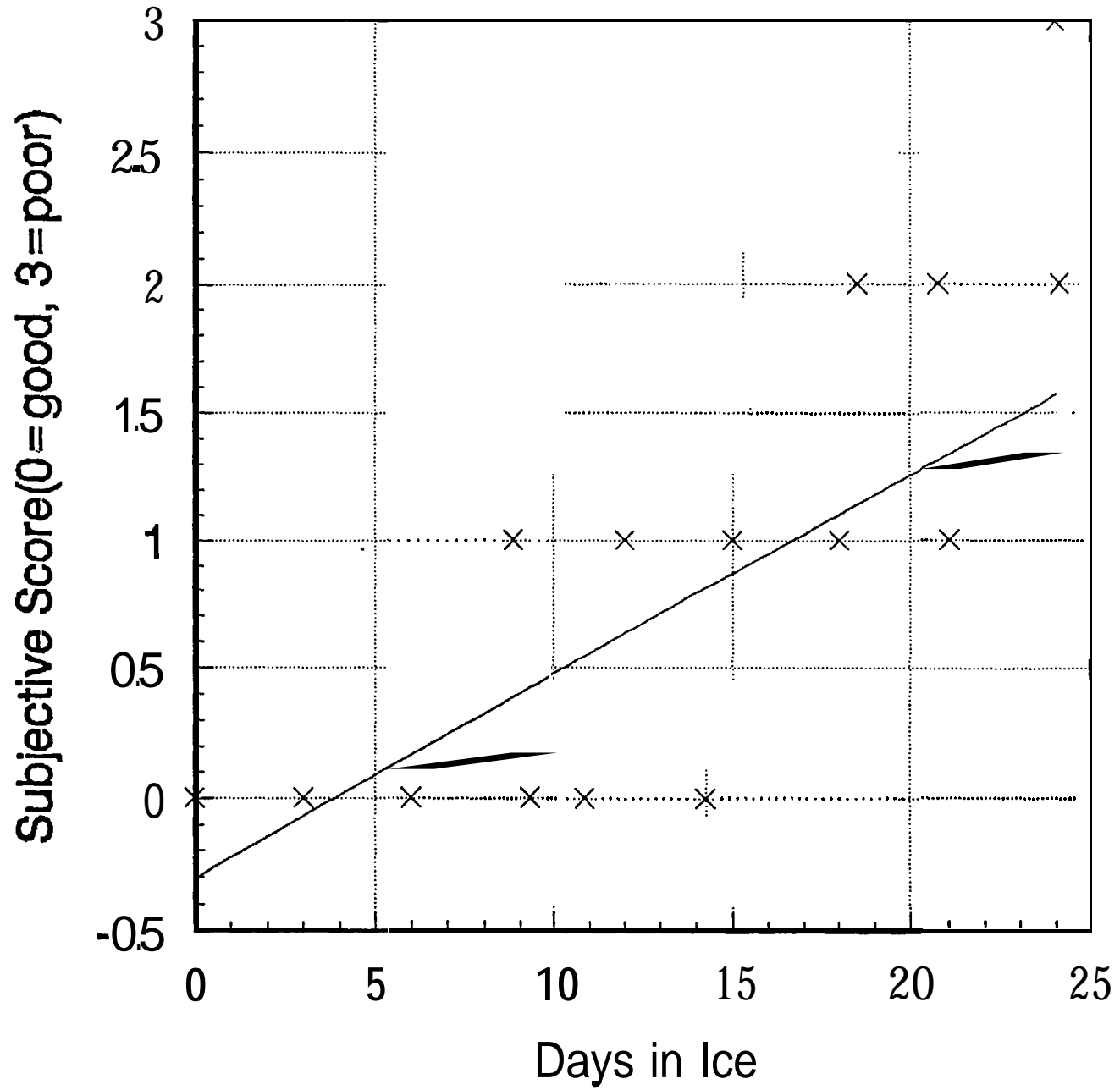

Appendix H-3.9. General Appearance With Days on Ice

FIGURE 8

# General Appearance

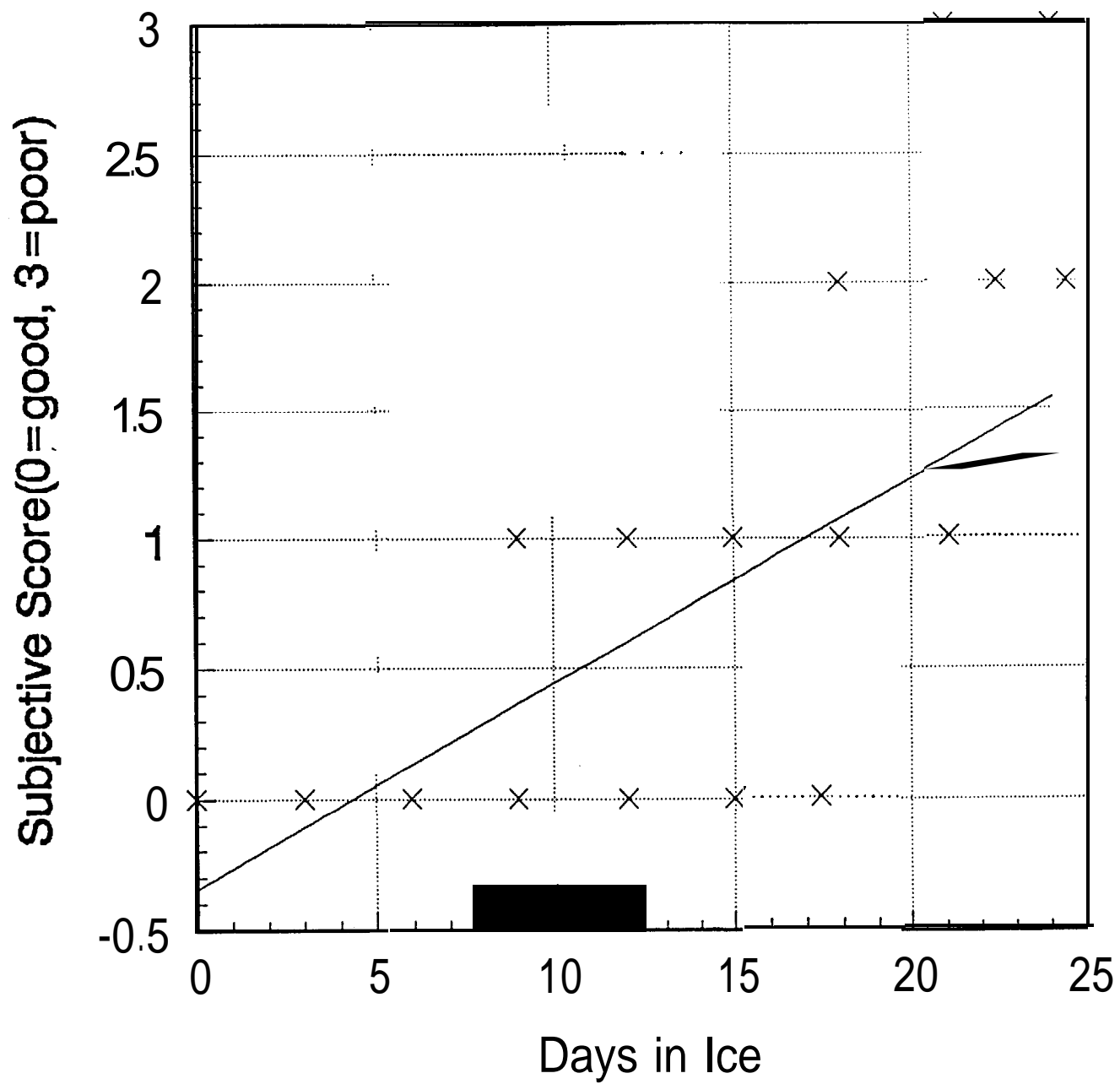

Appendix H-3. 10. Torrymeter Reading for Head Region

FIGURE 9

# Torrymeter Reading for Head Region

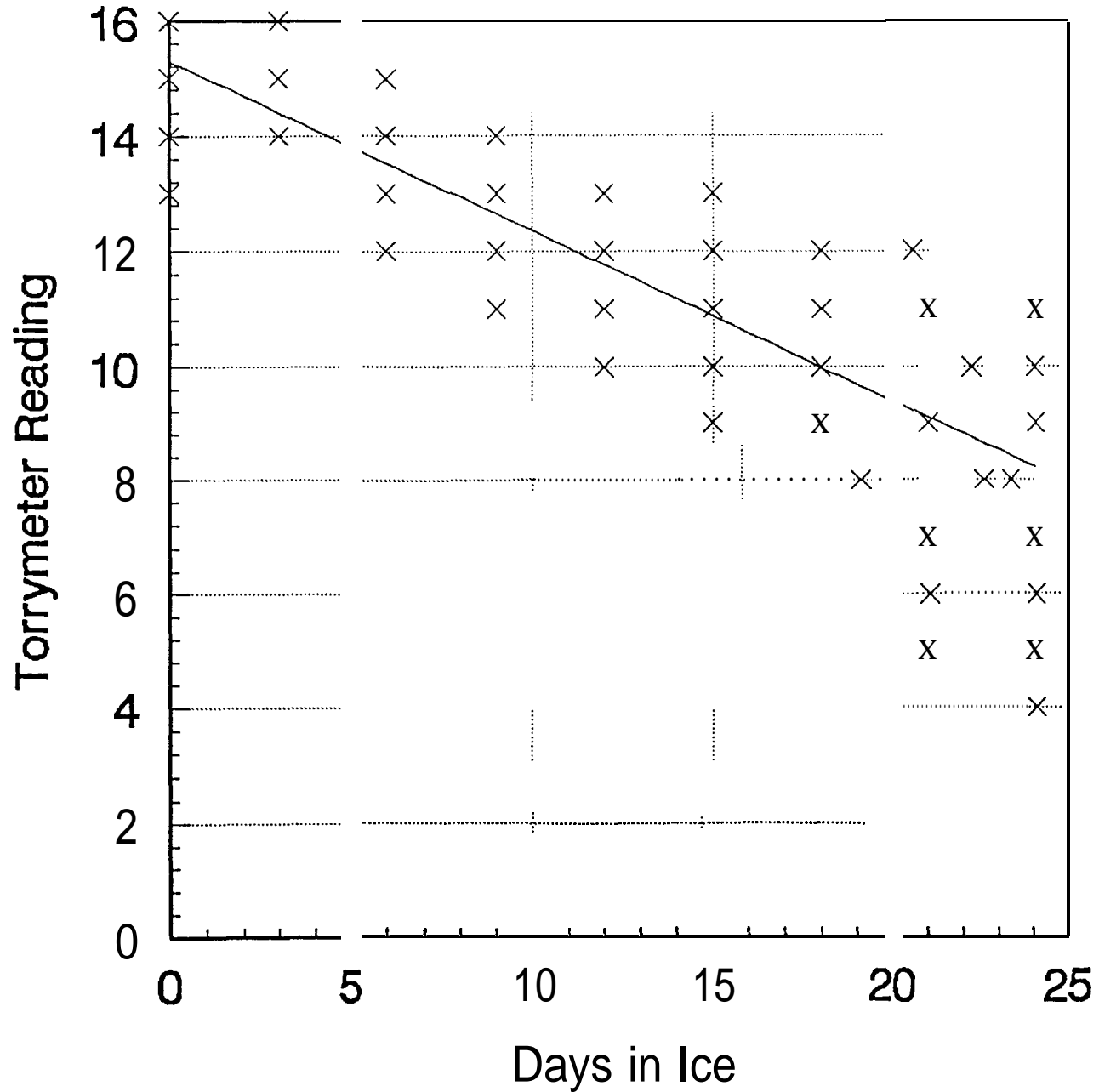

Appendix H-3.11. Torrymeter Reading for Middle Region



FIGURE 10

# Torryster Reading for Middle Region

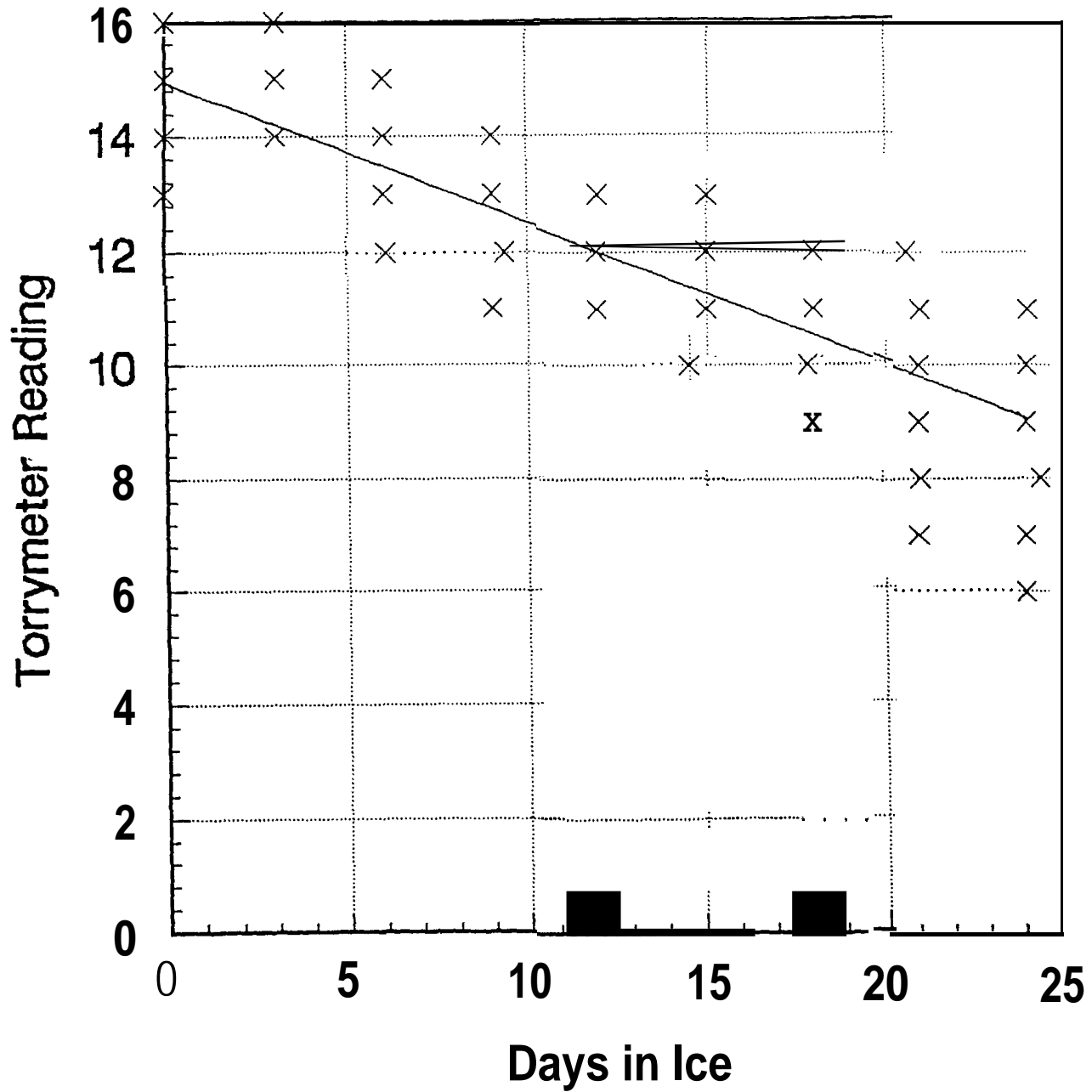

### Appendix H-3.12. Torrymeter Reading for Tail Region

FIGURE 11

# Torryster Reading for Tail Region

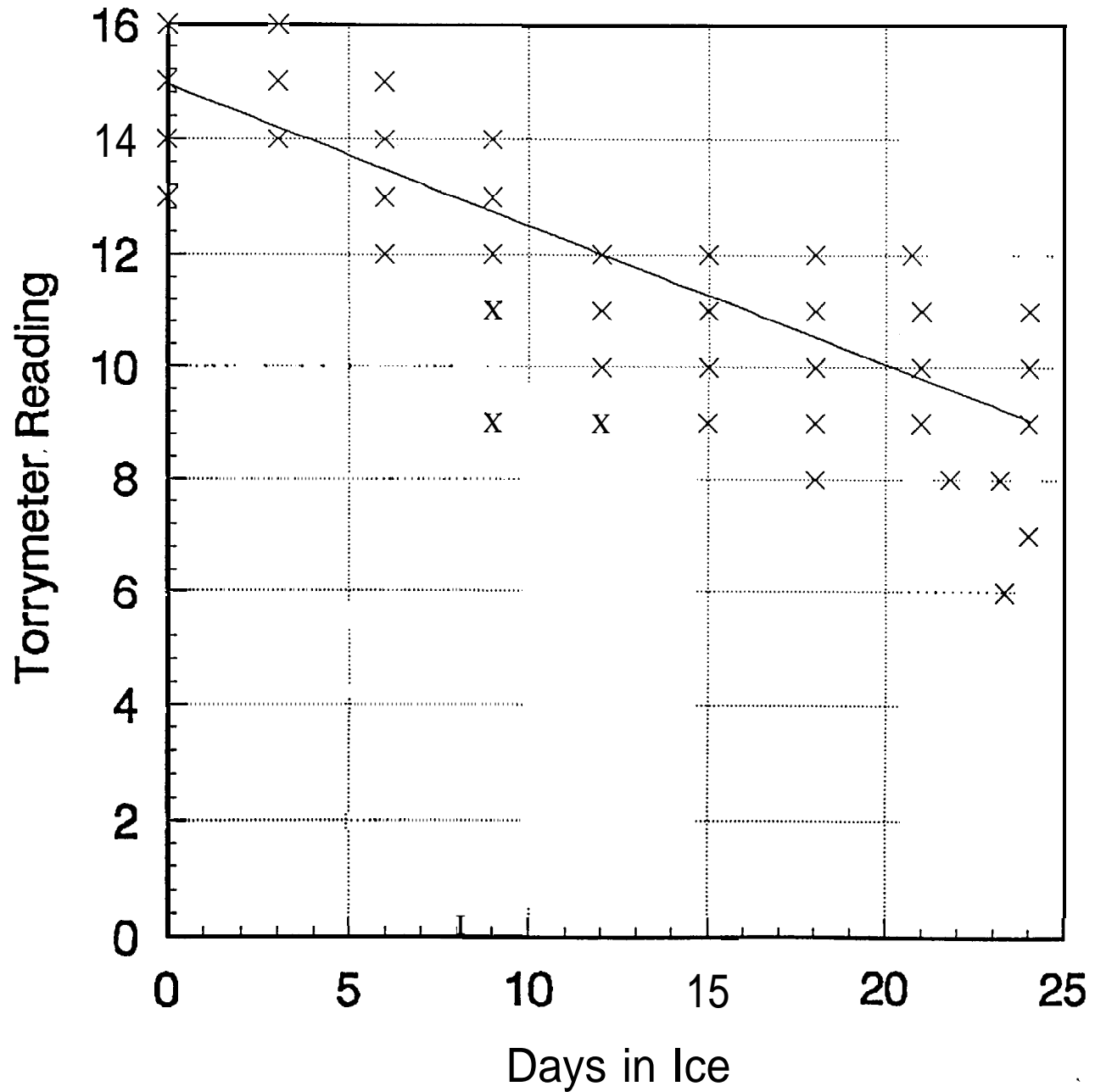

Appendix H-3. 13. Muscle pH of Squawfish

FIGURE 12

# Muscle pH of Squawfish

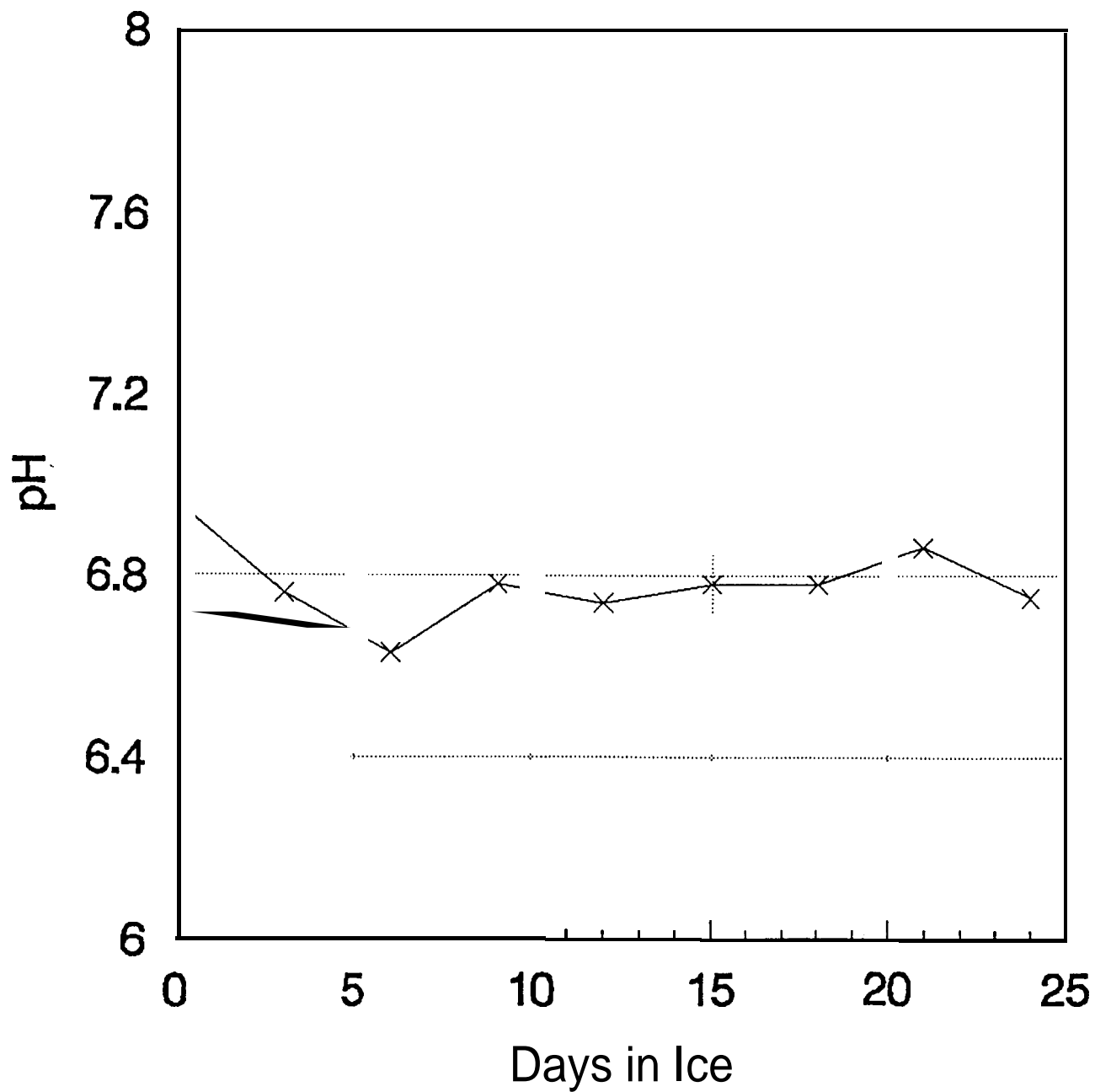

Appendix H-3.14. TBA of Squawfish

FIGURE 13

# TBA of Squawfish

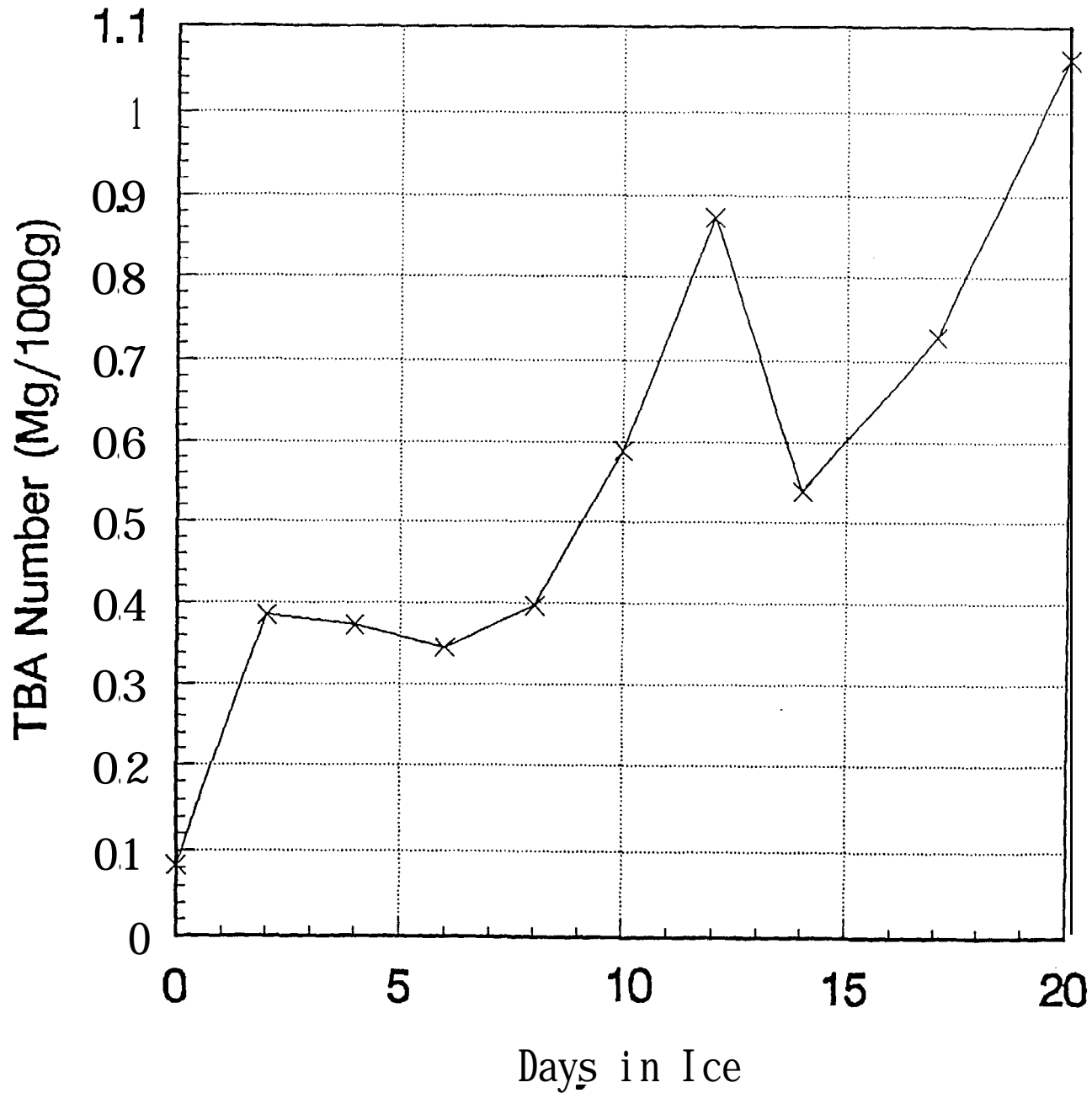

### Appendix H-3. 15. Changes in Total Plate Count



FIGURE 14

# Changes in Total Plate Count

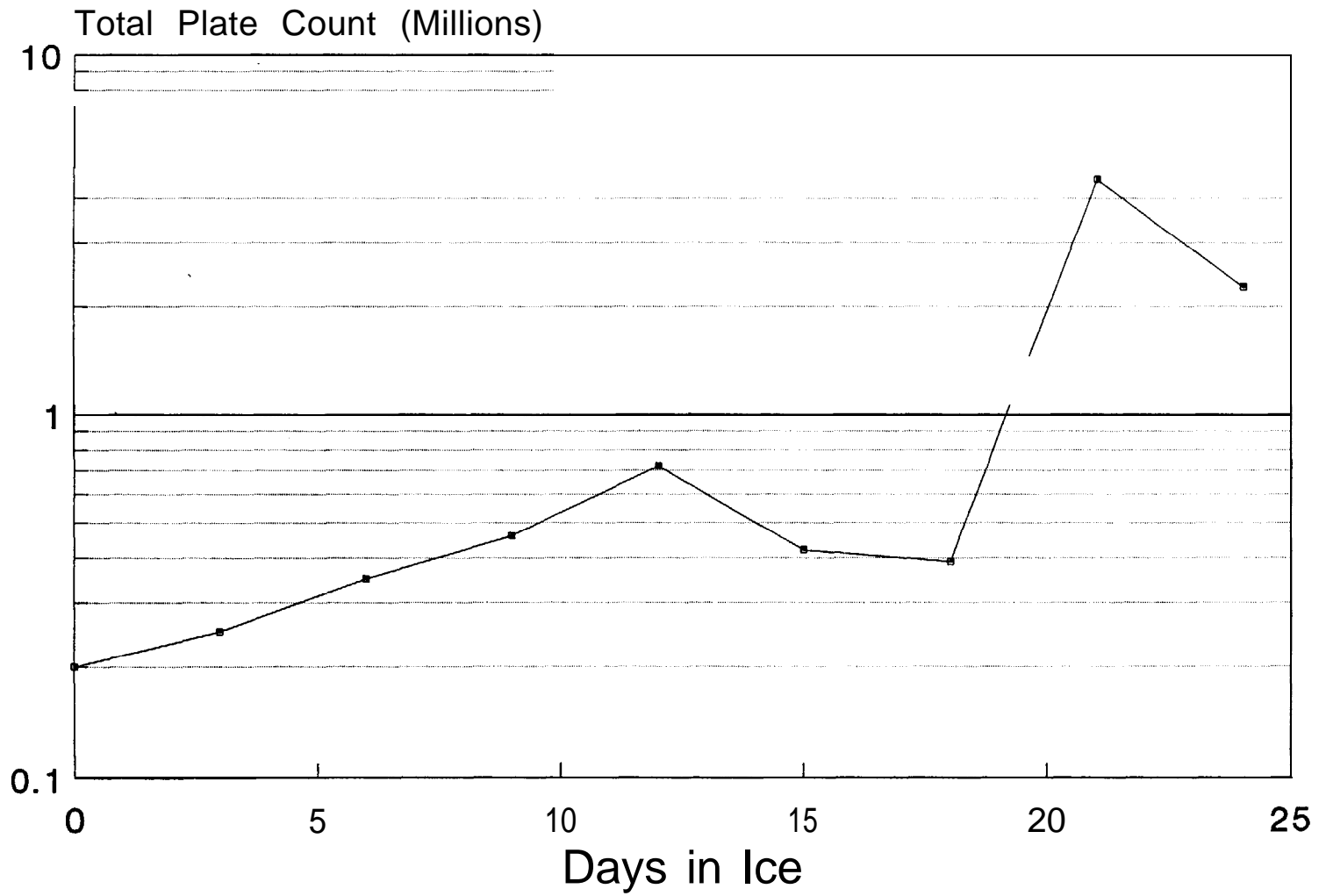

Appendix H-3.16. Stress/Strain for Squawfish

FIGURE 15

# Stress/Strain for Squ

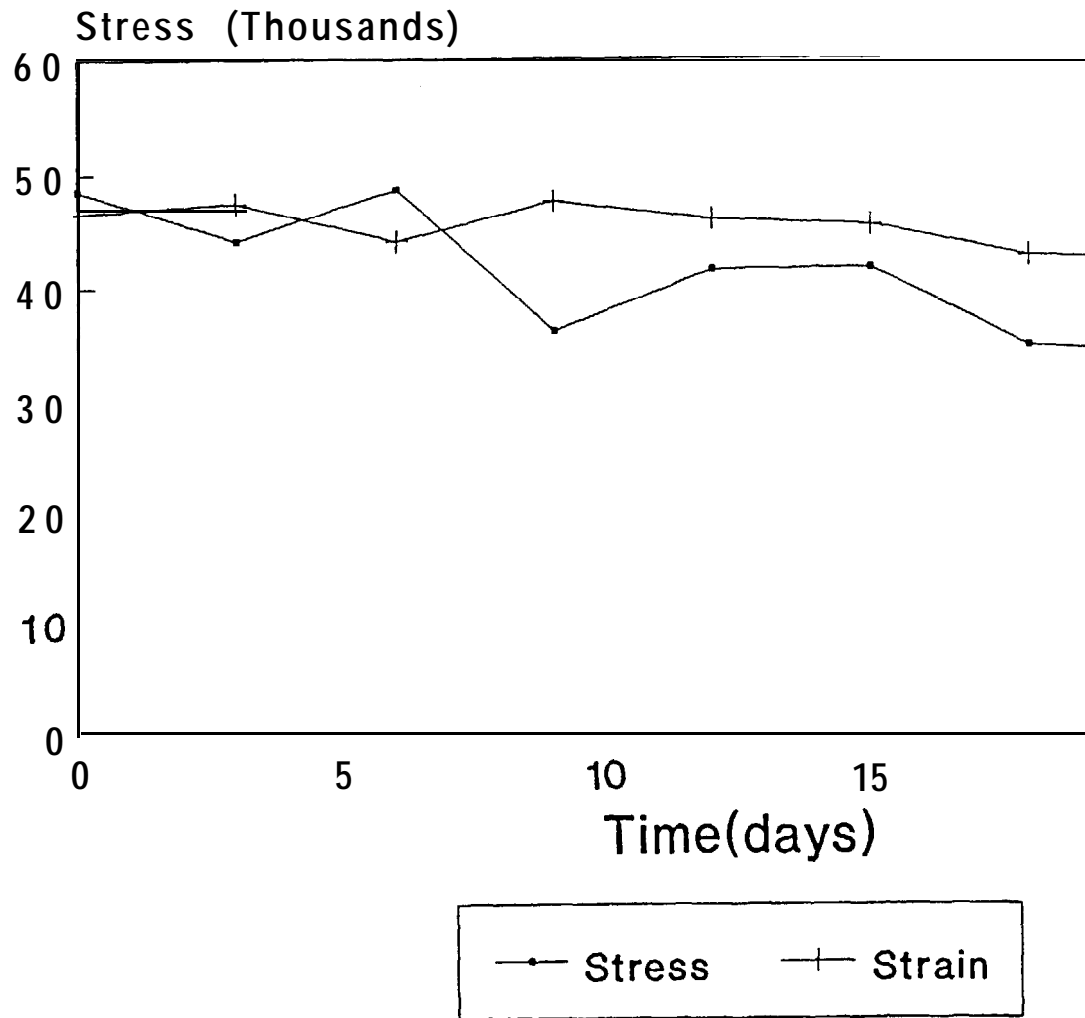

## Appendix H-3.17. Squawfish Grading Guide

## SQUAWFISH GRADING GUIDE

### 1. Record temperature

In order to assess whether fish has been properly iced at sea, determine its temperature. Insert a thermometer into the collar of the fish and push it through the flesh to a point midway down the flank.

Ensure that the tip of the thermometer is completely embedded in the flesh. Leave it in place for about 1 minute before reading and recording temperature.

Any accurate thermometer that can be inserted into the flesh is suitable. A dial or probe type may provide the least resistance. Accuracy of thermometer should be checked; temperature of ice and freshwater mixture is 0°C.

PROCEDURE

GRADE

### 2. Assess texture of fish flesh

Press thumb along lateral line for the anterior two-thirds of the fish. Do not press **along** the tail section, as it contains little flesh and mostly bones, and will not give a true indication of texture.

0 - flesh is firm and resilient, and springs back immediately when released.

1 - reasonably firm, some loss of resiliency, thumb indentations slowly fill out.

2 - moderately soft, thumb indentations may remain in flesh.

3 - excessively soft flesh.

## SQUAWFISH GRADING GUIDE

### 3. Assess odor at neck

For squawfish, using a sharp knife, make a 1 to 2 cm deep cut across the back of the neck just behind the gills. Spread the cut apart and determine odor by placing exposed flesh within 1 cm of nose. Do not cut more than 2 cm into the neck, because gill odors may be detected through the flesh.

- 0 - characteristic odor, fresh
- 1 - neutral, total absence of odor; characteristic odor no longer detectable but off-odors haven't developed.
- 2 - slight detection of off-odors
- 3 - off-odor, sour, putrid, bilgy, ammonia, unnatural odor.

### 4. Assess odor of gills

Grasp the bony coverings of the gills and pull them apart to expose and separate the gills. Examine the odor by placing the gills within 1 cm of the nose.

- 0 - characteristic of species, fresh
- 1 - Neutral - total absence of odor, characteristic odor no longer detectable but off-odors haven't developed
- 2 - slight to moderate sour odor
- 3 - very sour, strong, or putrid

### 5. Examine general appearance of fish

**Look at both** sides of the fish and examine its overall condition, giving particular attention to the skin.

- 0 - good overall appearance; skin lustrous and shiny, no fading
- 1 - good overall appearance, very slight bleaching of skin
- 2 - some **loss** of metallic **lustre**, some bleaching
- 3 - bloom gone from skin, color faded and bleached

**SQUAWFISH GRADING GUIDE****6. Examine eyes**

Closely examine the eyes on both sides of the head. It is essential to consider both eyes, so that a damaged eye (punctured by ice or fork; frozen; or flattened by other fish) is not mistaken for an eye which is sunken or cloudy from poor handling or aging. Assign the grade for the best eye.

- 0 - clear, bright, convex eyes
- 1 - slightly sunken or somewhat dull
- 2 - dull and/or cloudy
- 3 - very dull, sunken, and cloudy

**7. Note the appearance of the gills**

Pull the bony gill coverings apart and examine the gills closely for color and presence or absence of mucus.

- 0 - bright red, little mucus
- 1 - red, some mucus
- 2 - pinkish red to brownish, some mucus
- 3 - brown, may be covered with mucus

Fish Number										
Weight										
Length										
Iced/Temp (F)										
Texture										
Odor of Gills										
General Appearance										
Eyes										
Color of Gills										
<b>Torrymeter Reading</b>										
Head Region										
Middle Region										
Tail Region										

Fish Number										
Weight										
Length										
Iced/Temp (F)										
Texture										
Odor of Gills										
General Appearance										
Eyes										
Color of Gills										
<b>Torrymeter Reading</b>										
Head Region										
Middle Region										
Tail Region										





APPENDIX H-4.

Nutritive Composition of Stoller Fisheries Fish Meal

Table H-4. Nutritive Composition of Fish Meal Produced by Stoller Fisheries from Northern Squawfish and Carp.

	<u>Meal Percent Composition</u>		
	N. Squawfish Meal %	Carp Mixed Meal % 9/17/90	Carp Mixed Meal % 2/14/91
<hr/>			
<u>Component</u>			
Protein	<b>54.75%</b>	<b>56.1</b>	<b>55.2</b>
Fat	<b>14.94</b>	<b>20.6</b>	<b>18.6</b>
Moisture	13.1	12.2	12.4
Ash	<b>16.26</b>	<b>18.2</b>	<b>17.3</b>
NaCl *	.4	.36	.3
* Salt, expressed as Sodium chloride, NaCl			
<hr/>			

APPENDIX H-5.

OSU Mink Feeding Experiments

Table H-5. 1. Diet Composition of Experimental and Control Groups of Mink, Oregon State University **1991** Feeding Test.

Ingredient	% Composition	
	#1 (Control)	#7 (N. Squawfish)
Poultry by-products	<b>20</b>	20
Beef by-products	23	23
Fish (marine)	35	—
N. Squawfish	—	35
Cereal (50% wheat, 50% barley)	<b>11</b>	<b>11</b>
Water	<b>11</b>	11

Table H-5.2. Mean Weights of Control and Experimental Mink Groups by Time Period, Oregon State University **1991** Feeding Test.

	Weight (g)					
	<u>July 16</u>		<u>Aug. 13</u>		<u>Sept. 10</u>	
	M	F	M	F	M	F
Control	960	697	<b>1191</b>	<b>812</b>	<b>1569</b>	<b>1038</b>
N. Squawfish	938	659	<b>1289</b>	<b>793</b>	<b>1606</b>	<b>957</b>



APPENDIX H-6.

Report on Columbia River Shad Fisheries





Update on Columbia River Shad Fisheries and Markets and the Potential Impact  
of the Columbia River Northern Squawfish Predator Control Program

Jonh Pampush  
Sept 17, 1991

## INTRODUCTION

Each spring, millions of American shad (*Alosa sapidissima*) ascend the Columbia River and its tributaries, but a number of problems have precluded the development of a significant commercial shad fishery. The underutilization of Columbia River shad runs has been a longstanding frustration for the commercial fishing industry as well as fishery managers, especially since shad is a significant commercial fishery on the East Coast.

Currently, several factors are preventing the development of a large, sustained commercial shad fishery on the Columbia, and foremost among these problems is the lack of a product market. Other problems include the timing of the run and incidental mortality in shad **gillnets** of potentially endangered salmon and stealhead.

In 1991, as part of The Columbia River Northern Squawfish Predator Control Program, several technologies intended to remove northern squawfish were tested, and shad often appeared as **bycatch**. Because the current Columbia River shad fishery is still characterized as underutilized, it is unlikely that the incidental shad harvest by the Northern Squawfish program will affect the existing shad fisheries or markets.

### Life History of American Shad

The American shad is an anadromous fish that spawns in the **mainstem** of large rivers in late spring; adults return to the ocean after spawning. After hatching in about a week the young drift downstream and enter the estuaries in the fall. (Scott, W. and Crossman, E, 1973). Shad is a herring like fish with a strongly depressed body and large, silvery scales. Mature males average 2 to 3 pounds, mature females 3 to 4 lbs, and large individuals once weighing up to 15 pounds (Cheek, 1968).

### History of West Coast Shad Runs

Shad are native to the Atlantic coast of North America. Two major shad introductions occurred in western rivers that are thought to be primarily responsible for the current shad distribution on the Pacific Coast. The first of these introductions occurred in the Sacramento River in 1871 and the second in the Columbia in 1885. West coast shad now occur from the Mexican border to Cook Inlet, Alaska.

Shad were abundant in the Columbia below Celilo Falls prior to the construction of The Dalles Dam. The completion of The Dalles Dam in 1957 effectively removed Celilo Falls as a migration barrier and shad runs increased dramatically to current levels in excess of 1,000,000 fish annually (Young, 1970). The 1990 shad run was over 4,000,000 fish and is the largest on record, Table 1 summarizes Columbia River shad run size estimates and percentage of the run commercially harvested.

### History of West Coast Shad Fisheries

The first commercial shad landings on the Columbia occurred in 1889 and produced a 50,000 pound harvest (Browning, 1974).

Table 1. Columbia River Shad Run Sizes (in 1,000' s) and Percentage of Run Commercially Landed from 1977 - 1990 in 1,000' s (from ODFW summary data).

<u>Year</u>	<u>Min. Run Size</u>	<u>% Run Landed</u>
		7
1978	1,369.8	8
1979	1,546.0	8
1980	1,223.8	2
1981	1,159.9	2
1982	1,133.7	7
1983	2,082.6	4
1984	1,336.1	1
1985	1,445.0	2
1986	1,474.9	6
1987	1,417.9	8
1988	2,155.0	5
1989	3,105.0	2
1990	4,009.4	4

The Columbia river shad fishery peaked during the years 1926-1930 and 1946-1947 during which 1 to 1.5 million pounds were harvested in each of these years (Elwell, no date).

In recent decades, Columbia River shad runs have been greatly underutilized; since 1977, an average of only 5 % of each run has been commercially harvested (from Table 1). In 1981, due to poor market conditions and heavy fishing restrictions intended to protect adult salmon and steelhead, the shad harvest in the Columbia had fallen to 17,100 fish (Bowers 1981).

In 1990, 168,000 shad were commercially harvested from the Columbia, and another 113,000 were removed by sport anglers. Table 2 is a summary of Columbia River commercial shad landings from 1960-1990 (1991 data is not yet available). Table 3 is a summary of the lower Columbia shad sport fishery landings from 1974-1990. It is interesting to note that sport landings constitute a relatively high percentage of the overall fishery, but the combination of the two fisheries only harvested seven percent of the total run in 1990:

#### History of West Coast Shad Markets

In the eastern U.S., roe is the principal commercial shad product, where it is considered a delicacy. In the West, however, shad roe has never gained widespread acceptance. Earlier in this century, Columbia River shad were harvested for food (Craig and Hacker, 1940), but today most shad are sold as crab bait, mink food, or other low value products.

In 1990, Bonneville Fisheries, a fish processor in Cascade Locks, Oregon, purchased 131,000 pounds of Columbia River shad and processed a smoked product for marketing in southern California. The smoked shad did not sell well and Bonneville Fisheries did not buy any shad in 1991.

Table 2. Columbia River Commercial Shad Landings (in Thousands), Zones 1-6, **1960-1990** (from ODFW summary data)

Year	Pounds	Numbers	Year	Pounds	Numbers
<b>1960</b>	<b>170.3</b>	45.4	<b>1975</b>	<b>269.7</b>	73.0
<b>1961</b>	406.2	108.3	<b>1976</b>	<b>303.9</b>	80.3
<b>1962</b>	<b>894.4</b>	238.5	<b>1977</b>	243.3	62.5
<b>1963</b>	<b>859.3</b>	<b>229.1</b>	<b>1978</b>	460.3	<b>119.2</b>
<b>1964</b>	305.3	81.3	<b>1979</b>	<b>493.0</b>	<b>128.2</b>
<b>1965</b>	<b>354.9</b>	<b>94.6</b>	<b>1980</b>	<b>89.6</b>	23.4
<b>1966</b>	786.4	209.7	<b>1981</b>	66.7	21.8
<b>1967</b>	853.2	227.5	<b>1982</b>	<b>297.4</b>	76.5
<b>1968</b>	310.8	82.9	<b>1983</b>	<b>271.4</b>	85.3
1969	178.8	47.6	<b>1984</b>	<b>65.9</b>	<b>21.2</b>
<b>1970</b>	250.7	65.5	<b>1985</b>	<b>111.1</b>	35.4
<b>1971</b>	180.0	47.0	<b>1986</b>	<b>310.9</b>	<b>88.9</b>
<b>1972</b>	233.5	60.2	<b>1987</b>	350.0	121.0
<b>1973</b>	<b>210.7</b>	53.8	1988	385.2	127.5
<b>1974</b>	<b>195.2</b>	<b>49.5</b>	<b>1989</b>	<b>144.0</b>	<b>51.7</b>
			<b>1990</b>	450.7	168.0

Table 3. Lower Columbia River sport shad landings, **1974-1990**, (from ODFW data)

Year	# kept	# released	Year	# kept	#released
<b>1974</b>	<b>12,263</b>	--	<b>1981</b>	28,689	--
<b>1975</b>	<b>14,497</b>	--	<b>1982</b>	<b>33,914</b>	<b>1,428</b>
<b>1976</b>	<b>15,877</b>	--	<b>1983</b>	28,744	<b>4,960</b>
<b>1977</b>	2,804	--	<b>1984</b>	22,270	<b>1,700</b>
<b>1978</b>	15,683	--	<b>1985</b>	13,666	<b>3,950</b>
<b>1979</b>	12,442	--	<b>1986</b>	<b>18,914</b>	5,046
<b>1980</b>	24,280	--	<b>1987</b>	<b>14,349</b>	<b>1,940</b>
			<b>1988</b>	27,455	2,566
			<b>1989</b>	64,351	<b>18,966</b>
			<b>1990</b>	113,831	<b>21,841</b>

### Factors Limiting the Columbia River Shad Fishery

Poor West Coast market potential for shad products, principally roe, is the primary reason Columbia River shad runs are underutilized. Even in the face of dwindling East Coast runs, Columbia River shad have not been marketed successfully to Easterners because East Coast shad run earlier, are larger, and yield a larger roe skein than the Columbia River fish. The earlier runs on the East coast tend to satisfy the market before Columbia River shad become available to commercial fisherman. Currently, the West Coast market for shad products is nearly non-existent (conversation with D. Hobbs).

Those interested in establishing a significant Columbia River shad fishery are also faced with gear and season restrictions because the shad run coincides with potentially endangered summer chinook, summer steelhead, and sockeye runs. Typically, shad are caught in gillnets that often cause

**salmonid** mortality. Declining salmon and stealhead runs have forced fishery managers to restrict the timing and length of the shad commercial fishing season in an attempt to reduce salmon and stealhead mortality (Robbins, no date). The 1990 commercial shad season in the lower Columbia was only 19 days long (Between May 21 and June 15). In the last decade, however, the **salmonid** mortality problem has improved somewhat with the advent of more selective harvest gear (the market has remained depressed, however).

#### Attempts to Improve Selectivity of Shad Harvesting Methods

In response to the salmon and stealhead **bycatch** problems, several new harvest technologies have been investigated in an effort to find replacement gear for the non-selective **gillnets** typical of the shad fishery.

**Robbins** (no date) evaluated the effectiveness of a haul seine run from the shore in slackwater areas, and **Martin (1987)** explored the usefulness of a selective fish trap. Neither of these experimental gear types proved to be effective on a commercial scale.

**Robinson (1976)** compared various web strengths (denier) to determine if a lighter **gillnet** breaking strength might allow entangled salmon and stealhead to escape unharmed (at that time, maximum web strength regulations were in place but were not greatly reducing **salmonid** mortality). The experiment did not reveal a web strength that was strong enough for the effective harvest of shad and at the same time weak enough to allow a reduction in the **salmonid** mortality.

The development of the unflackered (straight hanging) floating **gillnet** has greatly reduced **salmonid** mortality during shad season. This gear utilizes a maximum ten pound breaking strength monofilament web with a four inch mesh size; **gillnets** of this type are mandatory for commercial shad fishing today. Salmon and stealhead that come in contact with the net are usually too large to become entangled in the four inch mesh, and the unflackered design usually allows them to "back off" and swim around the net (**Frazier, October 1991**).

Other harvest suggestions have been put forward, including modification of fish ladders, but the low market value of Columbia shad tend to preclude expensive harvest alternatives (**Young 1971**).

#### Future Shad Market Possibilities

Since the Columbia shad market has been poor for many years, very little current literature exists on the subject. Consequently, the information in this section is based on a conversation with Dalton Hobbs, Seafood Marketing Manager, Oregon Department of Agriculture. According to Hobbs, it appears Columbia River shad markets, at least for the near future, are not showing signs of noticeable improvement. However, the Japanese have shown interest in shad roe recently and marketing efforts in that direction are currently under way. The Koreans have also expressed some interest but have been unclear about specific products.

American shad, according to Hobbs, is a difficult item to market because this species possesses many undesirable seafood qualities such as "fishy" smell, strange appearance, and very bony skeleton. For now, it appears that

the small Columbia River shad fishery will not improve dramatically, and the shad harvested in the existing fishery will continue to be utilized as low value bait and animal food products.

#### Market and Fishery Effects of the Columbia River Northern Squawfish Predator Control Program

Several of the **1991** experimental Northern Squawfish Predator Control Program harvesting technologies (electro-fishing, Merwin trapping, and seining) had a tendency to harvest shad as well as squawfish. Since the final reports are not available at the time of this writing, the shad **bycatch** numbers can only be estimated to be several thousand, of which an unknown percentage became mortalities (for the most part, shad caught in these tests were released). Based on the current state of the West Coast shad markets and fisheries, it does not appear that the loss of this unknown number of shad will produce any adverse market/fishery effects.

## Literature Cited

- Bowers, W. 1981. Columbia River Commercial Shad Fisheries, 1981. Oregon Department of Fish and Wildlife Anadromous Fish Section, Columbia Management, Information Report 81-2.
- Browning, R. J. 1974. Fisheries of the North Pacific, Alaska Northwest Publishing Company, Anchorage, Alaska.
- Cheek, R. P. 1968. The American Shad. United States Department of the Interior, U. S. Fish and Wildlife Service Bureau of Commercial Fisheries Fishery Leaflet 614, Washington D. C.
- Craig, J. and Hacker, R. 1940. The History and the Development of the Fisheries of the Columbia River. Bulletin U. S. Bureau of Fisheries 49: 133-216.
- Elwell, T. No Date. American Shad as an "Underutilized" Species in Oregon. Marine Resource Management Program, School of Oceanography, Oregon State University, Corvallis, Oregon.
- Frazier, P. 1991. Oregon Department of Fish and Wildlife Biologist, personal conversations, October 3, 1991
- Hobbs, D. 1991. Seafood Marketing Manager, Oregon Department of Agriculture, Portland, Oregon. Personal Conversations.
- Martin, K and Martin, I. 1987. Development of an Alternative Gear for Harvesting Columbia River Shad: Final Report, 1987 - 1988. National Coastal Resources Research Development Institute, Newport, Oregon.
- Robbins, T. W. No Date. Evaluation of the Haul Seine for Commercial Shad Harvest, Columbia River, Oregon-Washington. Progress Report, National Environmental Services, Inc. Lancaster, Pennsylvania.
- Robinson, W. 1976. Evaluation of 46 and 69 Denier Gill Nets for Commercial Shad Fishing on the Columbia River, Information Report 76-3, Oregon Department of Fish and Wildlife Fish Division.
- Scott, W. and Crossman, E. 1973. Freshwater fishes of Canada. pp. 128-132, Fisheries Research Board of Canada, Ottawa, Bulletin 184.
- Young, F. 1970. Biology of Columbia River Shad and the Development of Selective Commercial Fishing Gear. Fish Commission of Oregon Research Division, Progress Report, January 1969 - September 1970.
- Young, F. 1971. Considerations for the Future Harvest of Shad in the Columbia River, Information Report, Fish Commission of Oregon Research Division.





APPENDIX H-7.

Commercial **Longline** Fishery

Table H-7. 1. Agency Expenditures by Category in the Commercial Longline Fishery for Northern Squawfish, preliminary data through 31 August 1991.

Expenditure Category	Total Expenditure through 31 August
Salaries/Wages	\$83,667
Fringe Benefits	17,052
Supplies	5,720
Operation and , Maintenance	6,468
Travel	43,132
Bait	1,850
Gear	<u>27,000</u>
TOTAL	\$184,889

Appendix H-7.2. Commercial Fishery Observer Survey Form

**Telephone Questionnaire for Commercial Fishery Observers  
Northern Squawfish 1991**

Interview date: \_\_\_\_\_ Interviewer: \_\_\_\_\_

We would like your help in evaluating the operation and conduct of the commercial longline fishery for northern squawfish this summer. Your answers will be kept confidential. Information from this survey will be reported in summary form only. Individual respondents will not be identified.

1. We would like your evaluation of several components of the commercial fishery operation, and any recommendations you have for change.

a. operating hours:                      good\_\_\_ fair- poor\_\_\_

recommendations: \_\_\_\_\_  
\_\_\_\_\_

b. registration process:                      good\_\_\_ fairpoor\_\_\_

recommendations: \_\_\_\_\_  
\_\_\_\_\_

c. data forms:                      good- fair- poor\_\_\_

recommendations: \_\_\_\_\_  
\_\_\_\_\_

d. data collection process:      good- fair- poor---

recommendations: \_\_\_\_\_  
\_\_\_\_\_

e. staffing:      good- fairpoor\_\_\_

recommendations: \_\_\_\_\_  
\_\_\_\_\_

f. equipment:            g o o d - f a i r - p o o r\_\_\_

recommendations: \_\_\_\_\_

g. interaction with fishermen:            g o o d - f a i r\_\_\_p o w - -

recommendations: \_\_\_\_\_

h. other recommendations:    g o o d - f a i r\_\_\_p o o r\_\_\_

2. We would like to have your assessment of any areas needing improvement in the operation of the commercial fishery.

3. We would like to have your assessment of areas which worked well in the operation of the commercial fishery.

4. We are interested in any thoughts you have as to why fisherman participation in the commercial fishery was at such a low level.

5. In your opinion, what was the most difficult part about being a commercial fishery observer?

---

---

---

6. What was most rewarding about being a commercial fishery observer?

---

---

---

THANK YOU FOR YOUR TIME.

APPENDIX H-8.  
Dam Angling Fishery



**Table H-8.1. Agency Expenditures for Dam Angling Fishery Operation by Site, preliminary data through 31 1991\*.**

Project	Cost
Lower Granite	NA
Little Goose	\$57, 972
Lower Monumental	60, 688
Ice Harbor	51, 979
McNary	NA
John Day	NA
The Dalles	49, 720
Bonneville	88, 523

. Project oversight costs not yet included

APPENDIX H-9.

Sport-Reward Fishery

**Table H-9.1. Agency Expenditures for Sport-Reward Fishery Operation by Site, preliminary data through 31 1991.**

Sport-Reward Site	Total Expenditure
Hamilton Island	\$37, 744
Covert's Landing	38, 023
Cascade Locks	34, 177
Bingen	35, 501
The Dalles	22, 784
Maryhill	26, 052
Le Page	36, 383
Plymouth Boat Ramp	28, 046
Columbia Point Park	22, 370
Hood Park	18, 029
Windust Park	21, 032
Central Ferry Park	32, 877
Lyons Ferry Park	22, 337
Chief Timothy Park	32, 026
Greenbelt Boat Ramp	<u>\$35, 105</u>
TOTAL	\$442, 486

**Table H-9.2. Total Agency Expenditures for Sport Reward Fishery Operations,  
All Sites, preliminary data through 31 August 1991.**

Expenditure Item	Total Expenditure
Salaries/Wages	\$304, 068
Supplies	11,009
Operation and Maintenance	55, 827
Indirect Costs	<u>71,580</u>
TOTAL	\$442, 484

Table H-9.3. Creel Clerk Assessment of Various Sport-Reward Fishery Components, 1991 Season.

<u>Component</u>	<u>Assessment</u>			<u>Recommendation</u>
	Good	Fair	Poor	
operating hrs.	6	3	2	<ol style="list-style-type: none"> <li>1. expand daily hrs.</li> <li>2. no midday break</li> <li>3. more advertis.</li> </ol>
regis. process	7	4	0	<ol style="list-style-type: none"> <li>1. shorten time</li> <li>2. one-time regis.</li> <li>3. automate regis.</li> <li>4. phone regis.</li> <li>5. regis I.D.</li> <li>6. better info to GP</li> <li>7. rolodex good</li> </ol>
check-in proc.	7	2	1	<ol style="list-style-type: none"> <li>1. more clerks</li> <li>2. more flexibility</li> <li>3. prior eve. regis</li> <li>4. exit diff. site</li> <li>5. elim. repeat vouch</li> <li>6. totes good</li> </ol>
data forms	7	2	2	<ol style="list-style-type: none"> <li>1. increase supply</li> <li>2. enlarge boxes</li> <li>3. prestamp <b>doc.#</b></li> <li>4. larger biod. frms.</li> <li>5. more info on reg. frm.</li> <li>6. make tech quest. consistent</li> <li>7. separate biosheet or put on front</li> <li>8. make room for <b>&gt;25</b> fish</li> <li>9. include I.C.</li> <li>10. shorten voucher</li> </ol>

Table H-9.3. (ctd.) Creel Clerk Assessment of Various Sport-Reward Fishery Components, **1991** Season.

<u>Comoonent</u>	<u>Assessment</u>			<u>Recommendation</u>
	Good	Fair	Poor	
data collection process	9	1	1	<ol style="list-style-type: none"> <li>1. increase time</li> <li>2. standardize for all sites</li> <li>3. accurate scales</li> <li>4. fish ID photos</li> <li>5. more info on form</li> <li>6. shorten forms or increase staff</li> <li>7. consist. training</li> <li>8. clarify data goals</li> <li>9. more scale cards</li> </ol>
staffing	7	3	1	<ol style="list-style-type: none"> <li>1. more training</li> <li><b>2.</b> tech 2 each site</li> <li>3. clarify lines of authority (<b>1&amp;2</b>)</li> <li>4. consist. superv.</li> <li>5. more eve. staff</li> <li><b>6.</b> more bios</li> <li>7. consist. data training</li> <li>8. reg. staff mtgs.</li> <li>9. increase #'s</li> </ol>
equi pment	5	5	1	<ol style="list-style-type: none"> <li>1. electronic scales</li> <li>2. lights</li> <li>3. sturdy tables</li> <li>4. organiz. misc.</li> <li><b>5.</b> scissors (clip)</li> <li><b>6.</b> \$ for incident.</li> <li><b>7.</b> less \$ on vans</li> <li>8. industrial weight equi pment</li> <li>9. sorting bins</li> </ol>

Table H-9.3. (ctd.) Creel Clerk Assessment of Various Sport-Reward Fishery Components, **1991** Season.

<u>Comoonent</u>	<u>Assessment</u>			<u>Recommendation</u>
	<u>Good</u>	<u>Fair</u>	<u>Poor</u>	
interaction with public	<b>10</b>	<b>1</b>	<b>0</b>	<ol style="list-style-type: none"> <li><b>1.</b> give crew positive attit.</li> <li><b>2.</b> more crew train.</li> <li><b>3.</b> more info for GP</li> <li><b>4.</b> fish ID photo</li> <li><b>5.</b> posters with answers to common questions</li> </ol>
stn. security	<b>9</b>	<b>2</b>	<b>0</b>	<ol style="list-style-type: none"> <li><b>1.</b> locking gas tanks</li> <li><b>2.</b> elect. on site</li> <li><b>3.</b> more lighting</li> <li><b>4.</b> no clerks work alone (esp. night)</li> </ol>

Table H-9.4. 1991 Creel Clerk Supervisor Recommendations for changes in Sport-Reward Fishery Operation, Public Complaints and Public Compliments.

Creel Clerk Recommendations

1. Open season earlier in the spring.
2. Extend season to 6 months, 5 days per week.
3. Expand daily hours.
4. Design 24 hr. sign-up.
5. Locate sites closer to Portland.
6. Increase publicity for program.
7. Let Tech 2's help evaluate throughout.
8. Create ID cards for repeat anglers.
9. lake all fish <11".
10. Improve and intensify creel clerk training on data, fish ID procedures.
11. Give more info about project to clerks and the public.
12. Standardize interview procedure on site.
13. Handle totes better.
14. Find places to drain totes.
15. Use freezers when catch is slow.
16. Cover sites so clerks are out of the weather.
17. Keep sites cleaner.
18. Have shuttle vehicles for techs.
19. Hire techs locally.

Complaints About Sport-Reward Fishery

1. Rate payers are the ultimate funders of the bounty.
2. WA merchants want a license required to fish n. squawfish.

Compliments on the Sport-Reward Fishery Operation

1. Creel clerks' relations with the public.
2. Public likes involvement with **salmon/steelhead** enhancement.
3. Local jobs.
4. Tackle and supply purchases
5. Money earned.





APPENDIX H-10.

Experimental Purse Seine Fishery

Table H-10.1. Expenditures by Category in the 1991 Experimental Purse Seine Fishery.

Expenditure Item	Total Season Expenditures	Ave. Expenditure per Set
Fuel	\$1,392	\$12.21
Oil	50	.44
Gear Repair and Replacement	6,540	57.47
Engine Maintenance	450	3.95
Insurance	2,700	23.68
Crew Pay	8,880	77.90
Food & Lodging	5,100	44.74
Misc. Supplies	200	1.75
Ground Transport	950	8.33
Telephone	<u>150</u>	<u>1.32</u>
TOTAL	\$26,412	\$231.68

APPENDIX **H-11.**

Comparison of Commercial, Sport, and Dam Fisheries

Table B-11.1. Expenditures for Monitoring Systems in the Commercial, Sport-Reward, and Dam Angling Fisheries, preliminary data through 31 August 1991.

	Commercial Fishery	Sport-Reward Fishery	Dam Angling Fishery
Total Agency Expenditure	\$184,889	\$442,486	\$385,887
Total Reward Payments	\$4,212	\$440,118	NA
Total Catch (N fish)	1,053	146,706	19,814
Expenditure per Fish Removed	\$179.58	\$6.02	\$19.48
Cost per Unit Effort**	NA	NA	NA

\*\* Effort units:  
Commercial = longline sets  
Sport Reward = angler hour  
Dam angling = angler hour

APPENDIX H-12.

Contaminant Tests

Table 1. Proximate Analysis of Unwashed and Washed Mince from Northern Squawfish

	Protein Ave. %	Moisture Ave % S	Lipid Ave % SD	Ave % SD	Ave % SD	Ave % SD		
Raw Mince	16.65	.17	78.4	.534	2.78	0.31	1.12	.0081
Mince First Wash	14.41	.267	83.07	.520	1.99	.056	.51	.0126
Mince Second Wash	14.06	.098	83.78	.450	1.74	.019	.41	.0153



Appendix H-12.1. Results of Dioxin Tests

Results of dioxin tests not received as of **9/30/91**





Table H-12.2.

Results of Hydrocarbon and **Organo** Phosphate Screen  
Performed on Northern Squawfish Oil Produced by  
Stoller Fisheries, Inc.



American Chemical Society, American Oil Chemists' Society  
American Feed Industry Association  
National Feed Ingredients Association  
Iowa Fertilizer and Chemical Association  
Iowa Grain and Feed Association

FAX 515-448-3102  
Since 1945

Reference Chemist, American Oil Chemists' Society  
Approved Chemist, American Oil Chemists' Society

LABORATORY REPORT NO.

25742

Date October 1, 1991

STOLLER FISHERIES  
P. O. Box B - Highway 9 & 71  
Spirit Lake, IA 51260

SAMPLE OF: Fish Oil  
MARKINGS: (Rec'd Y-10)  
METHOD OF ANALYSIS: Upon Request

CHLORINATED HYDROCARBON & ORGANO PHOSPHATE SCREEN

ANALYSIS:

RESULTS:

PCB - TOTAL	2.44 ppm
HEXACHLOROBENZENE - HCB	less than 0.01 ppm
RHC	less than 0.01 ppm
LINDANE	less than 0.01 ppm
HEPTACHLOR	less than 0.01 ppm
ALDRIN	less than 0.01 ppm
HEPTACHLOR EPOXIDE	less than 0.01 ppm
DDE	5.77 ppm
DIELDRIN	less than 0.01 ppm
ENDRIN	less than 0.01 ppm
DDD	less than 0.01 ppm
DDT	1.37 ppm
MIREX	less than 0.01 ppm
METHOXYCHLOR	less than 0.01 ppm
CHLORDANE	less than 0.01 ppm
TOXAPHENE	less than 0.10 ppm
DIAZINON	less than 0.10 ppm
METHYL PARATHION	less than 0.10 ppm
MALATHION	less than 0.10 ppm
ETHYL PARATHION	less than 0.10 ppm
ETHION	less than 0.10 ppm
RONNEL	less than 0.10 ppm

This assay completes report #25742.

NOTE: The above analysis was sub-contracted to an outside laboratory.

Respectfully submitted,

IOWA TESTING LABORATORIES, INC

Appendix H-12.3. Results of PCB Screen on Fish Meal



IOWA TESTING LABORATORIES, INC.

CONSULTING AND ANALYTICAL CHEMISTS

FERTILIZERS • OILS • FEEDS • PHARMACEUTICALS • SOILS • WATER

PHONE 515-448-4741 P.O. BOX 188 EAGLE GROVE, IOWA 50533



American Chemical Society, American Oil Chemists' Society  
American Food Industry Association  
National Feed Ingredients Association  
Iowa Fertilizer and Chemical Association  
Iowa Grain and Feed Association

FAX 515-448-3402

Since 1945

Reference Chemist, American Oil Chemists' Society  
Approved Chemist, American Oil Chemists' Society

LABORATORY REPORT NO. 25585

Date October 1, 1991

┌ 1  
STOLLER FISHMEALS  
P. O. Box B - Highway 9 & 71  
Spirit Lake, IA 51360  
└ ─┬─┘

W

Sample of: Fish Meal  
Sample Markings: (Rec'd 9-6)  
Method of Analysis: Upon Request  
ANALYSIS: RESULTS:  
Total PCB 0.29 ppm

This assay completes report #25585.

NOTE: The above analysis was sub-contracted to an outside laboratory.

**ORIGINAL** The above results reported on "as received" basis unless otherwise stated.  
The use of this report for advertising purposes is not permitted without our written consent.

Respectfully submitted,  
IOWA TESTING LABORATORIES, INC.





REPORT I

Columbia River Ecosystem Model (CREM) -- Modeling Approach  
for Evaluation of Control of Northern Squawfish Populations Using  
Fisheries Exploitation

Prepared by:

Lewis J. Bledsoe  
Helen Rudd  
Anderson F. Johnston  
Center for Excellence in  
Space, Earth and Life Sciences  
Computer Sciences Corporation





## CONTENTS

	<u>Page</u>
ABSTRACT .....	585
INTRODUCTION .....	586
OBJECTIVES.....	586
METHODS .....	587
Temperature Dependence .....	587
Estimation of Parameters .....	588
Theory .....	588
Objective function .....	589
Optimization spaces .....	591
Input Data .....	591
RESULTS .....	592
DISCUSSION.....	596
Optimizations .....	596
Final Parameter Values .....	597
Further Research Needed.....	597
LITERATURE CITED.....	599



## ABSTRACT

In order to accurately simulate the predation of juvenile salmonids and project their subsequent mortality it is necessary to have a model which accurately describes the change in the predator population due to the predator control fishery. The Columbia River Ecosystem Model (CREM) incorporates parameters (catchability coefficients) which describe the relationship between catch and predator fishing effort, for a given level of predator population. The observed catch rates, together with the known fishing effort by different gear types and in different reservoir areas, form a data base from which the CREM catchability coefficients may be determined. The criterion for determination is a set of coefficients which produce simulated catch patterns over time which are as close as possible to those which were observed. A mathematical optimization procedure which automatically operates the CREM simulator was programmed to determine the best values of coefficients according to this criterion.

This Parameter Estimation Procedure used with the CREM simulator (PEP/CREM) was employed to determine the best catchability coefficients for the 1990 predator control fishery. Since water temperature seemed to have a significant effect on catch rate, CREM was modified to include this effect and a temperature control parameter was also estimated by PEP/CREM. Because of the uncertainty in predator population size and distribution in the reservoir, these CREM parameters were also examined by PEP/CREM to determine if different values would improve the goodness-of-fit of predicted to observed catch data.

PEP/CREM was able to improve the model's average error in simulating each week's fishery catch from 12% (of the total catch of approx. 10,000 squawfish) to **1.1%**. Of the thirteen different gear type by area fisheries, catch errors ranged from **51%** to 2%; fisheries with the largest catch had the smallest error percentages. The mean error over all fisheries, weighted by total fish catch was **11%**. Use of the temperature effect parameter, as opposed to the previous CREM version without it, resulted in a 27% improvement of the catch error. However PEP/CREM was unable to improve the catch error significantly by variation in the initial predator population estimate or the estimates of predator distribution by reservoir area. Simulations with the optimized parameter values did not result in significant changes in **salmonid** mortality estimates, confirming the validity of earlier mortality estimates. However other model configurations must be analyzed with PEP/CREM before this result is conclusive. A major value from use of the PEP/CREM program is that it will provide numbers which are necessary in determination of confidence limits for **salmonid** mortality estimates.

## INTRODUCTION

The objectives of this study include the development and application of the Columbia River Ecosystem Model (CREM) to estimate **salmonid** mortality in the Columbia River under a range of possible conditions. In order to use the CREM effectively, parameters relevant to **salmonid** mortality, particularly those related to the predator population, must be estimated as accurately as possible.

This report describes the implementation of CREM into a computer based parameter estimation procedure (PEP/CREM), and the use of this procedure to refine initial estimates of predator population and of the effect of fishing on that population. The effect of a given amount of fishing effort under specified conditions (gear type, area of the reservoir, local predator density) is determined in CREM using a parameter called the catchability coefficient. The catchability coefficient determines, in a model, how the type of gear and the behavior of the predator interact with predator density to determine the effectiveness of a unit of fishing effort. The initial estimates of predator population, from Beamesderfer and Riemann (1988) and of catchability coefficients, as described in Bledsoe and Johnston (1991), are used as a starting point for the application of PEP/CREM. The initial values are refined to produce an optimal agreement between predicted catch and catch observed in the 1990 fishing season. The optimal parameters are then used as input to CREM to project future predator population levels and prey mortalities using different predator removal scenarios.

## OBJECTIVES

The objectives of this study are to determine:

1. the parameter values which allow the CREM to best describe the dynamics of predator populations under the predator control fishing effort of 1990;
2. the predator population sizes, densities and distributions in John Day reservoir which are most consistent with the dynamics of the predator control fishing effort and previous population estimates;
3. the accuracy of CREM with parameters determined in 1. for description of predator population dynamics under the 1991 control fisheries; and
4. the appropriate revised estimates of **salmonid** mortality due to predator interactions in lower Columbia reservoirs.

This preliminary report will address only objectives 1. and 2. Current **salmonid** mortality estimates, including a projection of future mortality in response to the predator control effort, are contained in last year's (1990) final project report. The final report for this year (1991) will address all four objectives.

## METHODS

The Columbia River Ecosystem Model, version 2.1, was described and documented completely by Bledsoe et al (1990) and Bledsoe and Johnston (1991). The model used in this report is the same except for the number of discrete areas used to describe John Day reservoir. In this application of the model, five areas are used rather than the three used in the latter reference. The input parameters describing these areas are detailed in Table 1.

Table 1. Input parameters describing the divisions of John Day reservoir used in the model. The values for predator distribution are the initial values for the optimization procedure.

Subdivision	Area (m <sup>2</sup> , X10 <sup>6</sup> )	Initial number of predators
<b>Tailrace</b>	<b>.46</b>	2817
<b>Midbay</b>	166.	65092
Near shore	21.	8250
Channel	21.	8250
<b>Forebay</b>	2.3	907
Total	210.76	85316

### Temperature Dependence

To test the effects of temperature dependence of catchability, modifications were introduced into CREM version 2.1, as described below. This modified version will be referred to as CREM 2.11. In order to perform the parameter optimization procedures (PEP) for initial predator parameters and for catchability coefficients, a driver was added to version 2.1 to produce PEP/CREM version 1.0.

CREM 2.1 uses constant catchability coefficients, indexed on gear type and reservoir area, in determining the rate of predator catch given predator density, area of the reservoir, type of gear being used and amount of effort expended with that gear. Catchability is the catch rate produced by a unit of effort applied to a unit predator density within a gear-area subdivision. The coefficient reflects the interaction of the predator's behavior with a certain type of gear. Implicit in the concept are certain assumptions about the time stationarity (i.e., constancy) of fish behavior with respect to fishing.

Predator behavior is affected by water temperature. Since one of the objectives of this study is to model the predator's behavior and its effect on catchability more accurately, the CREM 2.1 catchability coefficient parameter  $pq$  was modified to become an intermediate system variable scaled according to temperature. The resulting version of the model is CREM **2.11**. The scaling function was defined using parameters that could be estimated by PEP/CREM to determine the optimal shape of the function.

The underlying relationship is **modelled** by an exponential function. That is, catchability coefficients are assumed to increase exponentially as a **function** of the water temperature at the time of the catch. The function is defined as follows:

$$q_{ij} = pq_{ij} \exp( ptl T )$$

where:

$q_{ij}$  is the temperature varying catchability coefficient for area  $i$ , gear  $j$ ;

$T$  is the water temperature in degrees Celsius;

$pq_{ij}$  is a parameter describing the area and gear variation of catchability;

$ptl$  is a parameter describing the temperature variation of catchability.

The parameter  $ptl$  is varied to determine the optimal form for the relationship and the catchability of the predator species. The same value of  $ptl$  is assumed to apply to all gear types and areas, though the catchability coefficients themselves vary with gear and area.

Temperature data

Temperature data for the John Day reservoir in for the **1990** season were provided by the Fish Passage Center of the Columbia Basin Fish and Wildlife Authority. These data were used for each year in the subsequent projections, assuming that the annual temperature profile would not alter significantly in the near future.

#### Estimation of Parameters

Theory

The general theory used for determination of model parameters in this study is that a necessary condition for predator population based estimates of **salmonid** mortality to be credible is that the **model must correctly describe** dynamically the observed pattern of fishery catches. Fishery catch rate is assumed to be proportional to predator population density at an instant of time. The proportionality constant, or catchability coefficient, is assumed to either not vary in time, for a given fishing gear and type of effort, or to vary only systematically with some uncontrollable environmental or behavioral variable (eg temperature or fish spawning condition). Credibility of mortality

estimates is also dependent upon other factors, such as the model description of the predation process and correctness of driving functions. However validity of these factors has previously been treated by comparison with research results or is assured in other ways.

Correct description of fishery dynamics is measured by the square root of the average, over time, area and gear type, of squared differences between a predicted and an observed catch. Averages are taken over weeks of time for each area-gear combination for which data is available. This number is called a root mean square (RMS) error criterion for "goodness of fit" or, simply, "the fit", to the data.

The general method used to determine the parameters (catchability coefficients, initial population size, relative distribution in space, or any other model parameter or initial condition) which give the best fit (least RMS error) to the catch data is as follows. Beginning with any initial parameter set, such as that used in the previous CREM reports, simulate the system (i.e. execute or run the model) and calculate the RMS error. Each parameter is then individually modified slightly, the model is re-run, and the new error is calculated. The resulting set of RMS error values, one more than the number of parameters being estimated, are used by a mathematical optimization procedure to calculate a new set of parameter values which should result in a smaller error. This new parameter set is used for a simulation run and the new error is evaluated. Whether the new error value is an improvement or not, the procedure is repeated so that a series of RMS error values are produced, one for each iteration of the optimization procedure. At some point in these iterations, the optimization procedure uses a completion rule to determine that no further reduction in RMS error is possible. The optimization procedure, when applied as described to the problem of parameter estimation, may be called a parameter estimation procedure; when used with the CREM we will refer to the procedure as PEP/CREM.

There are a number of different continuous variable **mathematical** optimization methods that may be used as a part of PEP/CREM. We chose the modified Levenburg-Marquardt method (Dennis and Schnabel 1983) as programmed in the IMSL, Inc. (1990) Mathematics Library. The main driver procedure of the CREM version 2.1 simulation program was modified to a subroutine, SUBCREM, with arguments which included input parameters for predator population and for catchability coefficients. Output parameters were added to include a vector of the differences between CREM predicted predator catches and the catch data observed in 1990. A new driver was written incorporating the routine UNSLF from IMSL Math Library Version 1.1. The driver allowed the IMSL routine to execute SUBCREM using input parameters from the specified optimization space, and to take SUBCREM output ( the vector of predicted and observed catch differences) as the value to be minimized. This system is PEP/CREM 1.0, in which CREM 2.1 is treated as a function whose output is to be optimized.

PEP/CREM is implemented in the **Fortran** programming language on a Sun Microsystems, Inc., **SPARCstation 2** workstation. It was purchased specifically for the purpose of enhancing execution of earlier versions of PEP/CREM implemented on a Digital Equipment Corp. VAX 11/780. Execution is seven to 10 times faster on the workstation.



## Objective function

The objective function for an optimization procedure is the mathematical function whose value is to be minimized (or maximized) over the optimization space, or set of parameters for which estimates are desired. A least-squares parameter estimation procedure is a special case of an optimization procedure in which the objective function includes a sum of squared error terms, such as the RMS error. Since catch values are indexed over time, area and gear or fishery, the summation in the objective function can be calculated in a variety of ways. If the catch is completely aggregated, PEP produces only a fit of predicted total catch to that observed; if catch is **completely** disaggregated over all indices, PEP can optimize for a good fit to each individual fishery-area combination. This latter method, which provides the most data points to be used in the fit, is the most sensitive to parameter values and is the objective function used for PEP/CREM estimates. Mathematically, this is defined as follows, using the notation described in Bledsoe et al. (1990):

(Objective function 1)

$$\{(S_{ijk} [ (C^*_{ijk} - C_{ijk})^2 ])/n\}^{1/2}$$

where:

C is the predicted cumulative catch for gear i, area j and week k;

C\* is the observed cumulative catch for gear i, area j and week k; and

n is the number of elements in the summation.

The optimization method requires substantially greater amounts of computer time for an objective function with a greater number of terms in the sum of squares, therefore preliminary explorations with PEP/CREM have involved the use of aggregated catch measures, as described below.

There are two objective functions used for the runs described in this preliminary report. The first is defined by calculating the squared difference between the total (over all gear types and areas) predicted and observed catch at each one week time step. These differences are consecutively summed over one week time steps through the fishing season, yielding cumulative total catch, and the square root is taken of that sum. Mathematically, this is:

(Objective function 2)

$$(S_k [ (S_{ij} [ (C^*_{ijk} - C_{ijk})^2 ] ) ])^{1/2}$$

The second form of objective function is defined by calculating the squared difference between predicted and observed catch for each gear at each one week time step. These differences are consecutively summed over one week time steps through the fishing season, yielding cumulative total catch, and the square root is taken of that sum. Mathematically, this is defined as follows:

(Objective function 3)

$$(S_{jk} [ S_i [ (C^*_{ijk} - C_{ijk})^2 ] ] )^{1/2}.$$

The subtle differences between these two objective functions determines whether the PEP is sensitive to errors only in total fishery catch over time or catch by area over time as well.

#### Optimization Spaces

Explorations of several different optimization spaces were made with PEP/CREM in order to examine the behavior of the optimizer. The purpose of these explorations was to determine the extent to which the catch data from the predator control program contained information which was useful for determination of CREM parameters. If a data set contains no information concerning the values of the components of a parameter space, the optimization procedure will be unable to reduce the error, or the reductions will be insignificant. The mathematical equations of CREM contain some terms, particularly in the catch equations, in which catchability coefficients are partially confounded with predator population distribution. The confounding is not complete because of the different kinds of dynamics for these two variables. However, if the observed data does not contain the right kind of variability, the optimizer will not be able to distinguish catchability coefficients from initial population sizes and it will be impossible to make estimates of both parameter subsets. For this reason, some exploration of properties of the system are required.

The spaces can be classified as follows:

1. the estimate of initial predator population size;
2. subsets of the catchability coefficients;
3. the parameter  $p_{tl}$  defining the temperature dependency relationship of catchability coefficients in CREM 2.11.
4. combinations of 1., 2. and 3., including an optimization over all parameters.

#### Input Data

Initial values for predator population and distribution, as well as for catchability coefficients, are, except where noted, those described in Bledsoe and Johnston (1991). Driving inputs, such as passage numbers, fishing effort, catch and temperature were also described in that paper.

The division of the John Day reservoir into five parts, as in previous models, was also incorporated into these runs, as shown in Table 1. Fishing effort and catchability coefficients were assumed to be zero in the near shore and channel regions of the reservoir.

Initial estimates for the temperature dependency parameter **ptl** were derived from examination of the temperature data and the estimated catchability coefficients. The coefficients were assumed to be representative of the temperature of the water at mid-summer, about 16 degree centigrade. **It** was also estimated that the catchability would double over the range from **10** degrees centigrade to **21** degrees centigrade. From these assumptions, values for the **ptl** parameter was derived mathematically.

## RESULTS

Table 2 contains a summary of the executions of the PEP/CREM computer program, giving the optimization space, model version, number of CREM executions required (i.e. iterations), objective function used, initial and final RMS error and the percentage change in the error. The first **10** executions were made using the aggregated objective function **2**; the latter five used the disaggregated function **1**.

Table 2. Summary of optimization space, model, objective function, initial and final catch errors for executions of PEP/CREM. Initial and final RMS error values are percentages of the total catch; Iter. means number of iterations or executions of the CREM simulator required for the optimization; Obj. refers to the number of the objective function as defined in the text. "N" refers to the size of the initial predator population; "N<sub>i</sub>" refers to the spatial distribution of the predator population.

No.	Optimization space	CREM Version	Iter.	Obj.	Initial RMS	Final RMS	Per Cent Change
1	3 pq's	2.1	52	2	11.56	5.00	-57
2	ptl	2.11	24	2	3.74	2.93	-22
3	3 pq's, N	2.11	48	2	2.93	2.63	-10
4	3 pq's	2.11	42	2	2.93	2.91	-1
5	13 pq's	2.11	196	2	2.93	2.72	-7
6	13 pq's, N <sup>a</sup>	2.1	1184	2	31.00	2.35	-92
7	13 pq's, N	2.11	528	2	2.93	1.66	-43
8	13 pq's, ptl, N	2.11	539	2	2.93	1.66	-43
9	13 pq's	2.1	198	1	2.44	1.55	-36
10	13 pq's, ptl	2.11	238	1	3.20	1.09	-66
11	N, N <sub>i</sub>	2.11	23	1	1.11	1.12	+1
12	13 pq's, ptl, N, N <sub>i</sub>	2.11	1485	1	1.11	1.10	-1

Notes:

<sup>a</sup> Initial value for N set to 1.5X ODFW estimate.

Table 3 shows, for the parameter sets which have the smallest catch error with the disaggregated objective function, optimum values of all parameters in the optimization spaces of Table 2. For the catch coefficient parameters, RMS error for the relevant fishery is also reported, both in catch units and as a fraction of the total catch in the fishery. The average RMS error over all fisheries was 5.1% of the catch in each fishery, however the RMS average error weighted by the catch in each fishery was 1.9%. By contrast, the RMS average error over all fisheries, weighted by catch, was 27.1% using the preliminary estimates of catchability coefficients (as used in previous analyses with CREM).

Table 3. Optimum values of parameters; RMS error for predicted catch in each fishery - area combination. Abbreviations: FWS, U.S. Fish and Wildlife Service; ES, electroshock gear; OR, Oregon Dept. Fish and Wildlife; Comm., commercial longline gear.

Parameter	Value	Catch error (RMS)	Catch error (% of catch)
FWS ES Tailrace pq1	<b>888.0</b>	<b>19.3</b>	<b>8.3</b>
FWS ES Reservoir pq2	<b>888.3</b>	<b>14.7</b>	<b>9.1</b>
FWS ES Forebay pq3	<b>2340.</b>	<b>11.8</b>	<b>23.1</b>
OR ES Tailrace pq4	<b>208.5</b>	<b>16.7</b>	<b>26.9</b>
OR ES Reservoir pq5	<b>694.8</b>	<b>1.32</b>	<b>10.1</b>
OR ES Forebay pq6	<b>105.7</b>	<b>18.2</b>	<b>51.9</b>
Comm. Tailracepq7	<b>262.9</b>	<b>43.4</b>	<b>7.2</b>
Comm. Reservoir pq8	<b>3874.</b>	<b>27.1</b>	<b>3.3</b>
Sport Tailracepqg	<b>35.06</b>	<b>41.8</b>	<b>2.7</b>
Sport Reservoir pq10	<b>1714.</b>	<b>73.8</b>	<b>73.8</b>
Sport Forebay pq11	<b>1373.</b>	<b>217.</b>	<b>7.0</b>
Dam Tailrace pq12	<b>789.5</b>	<b>334.</b>	<b>8.8</b>
Dam Forebay pq13	<b>14.51</b>	<b>12.2</b>	<b>39.5</b>
Temp. coeff. pt1	<b>.06706</b>		

Figure 1 shows a graph of the time series of observed and predicted catch in each of the four fisheries with the largest catch (Dam tailrace, 3819; Sport forebay, 3115; Sport tailrace, 1564; Commercial reservoir 814).

Figure 1. Time series of observed and predicted cumulative catch using PEP/CREM optimised parameters.

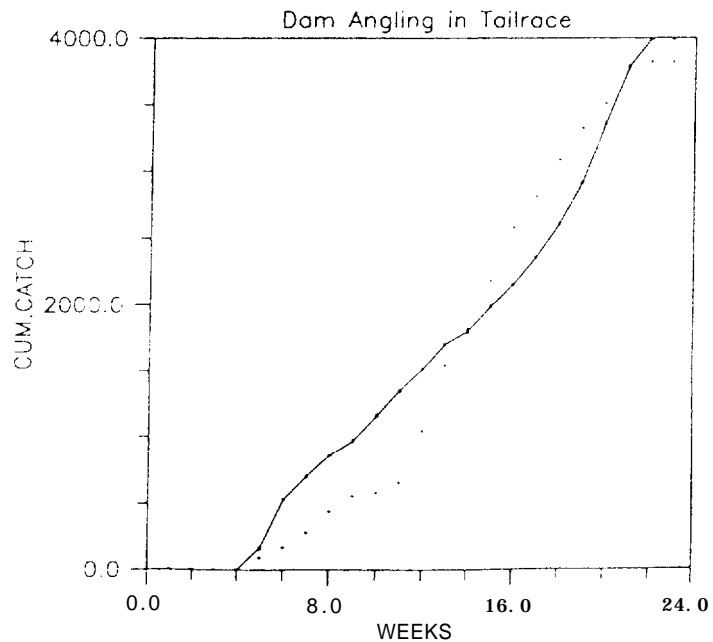
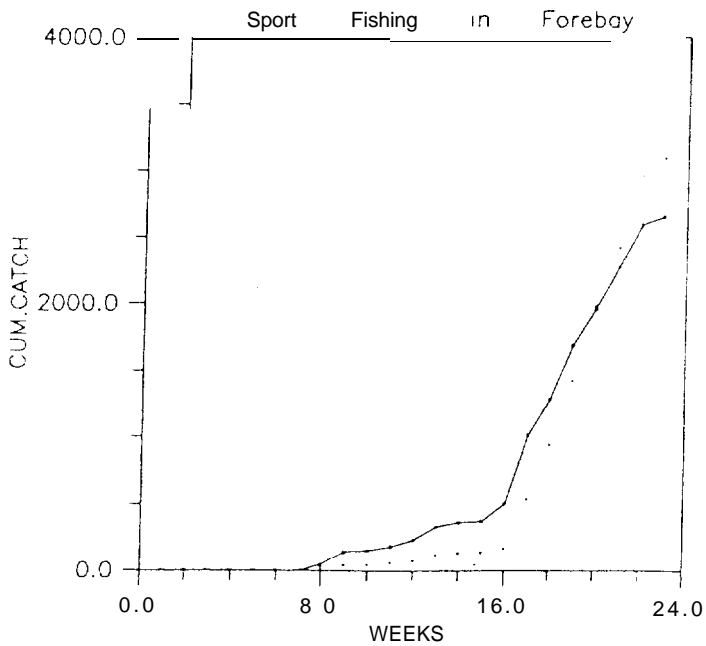
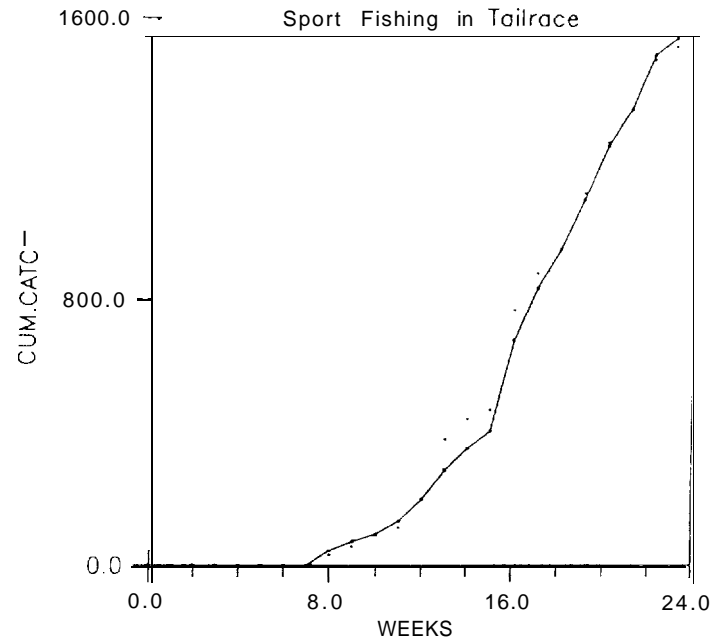
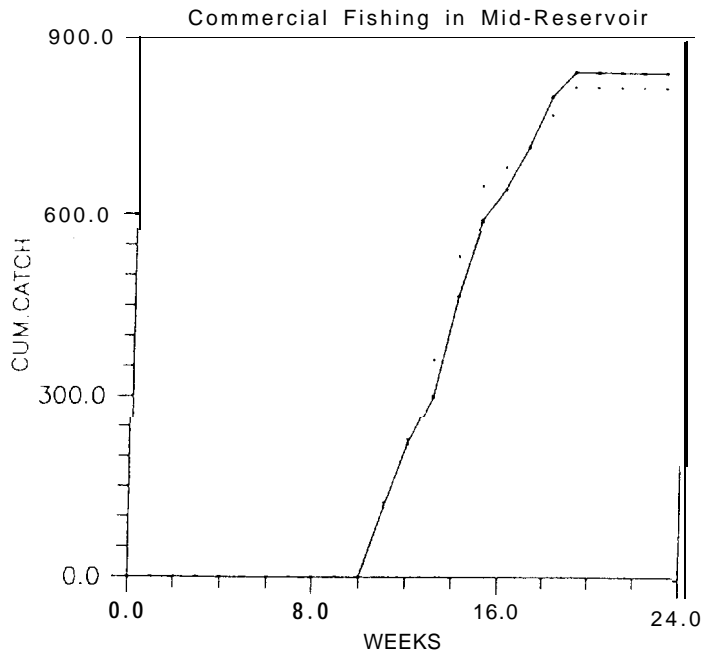

## DISCUSSION

### Optimizations

The first 10 optimizations were performed with objective function number 2 which is sensitive only to the time series of total catch by all fisheries and not to the catch time series within each gear - area combination. These were done in order to investigate the characteristics of the parameter estimation system using small optimization spaces and small sets of observed data. The catch time series utilised the weekly total catches of all gear - area fisheries, a total of 23 data points. By contrast, the total catch data set included 23 weekly time points times 13 fisheries, or 299 data points.

The first three runs, demonstrate the effectiveness of incorporating temperature dependence into the catchability coefficients. The optimization is on a small set of parameters but produces a considerable improvement in fit to the observed data. The last run of the series, incorporating the results of optimization on the *ptl* temperature dependence parameter, achieved an optimal fit with just over half of the error inherent in the fit of the first run. The value of *N*, the initial predator population size, was not substantially modified by the optimization. The initial estimate of population was 84800 and the optimized estimate was 84844.

In optimization 4, the results of estimation of three of the catchability coefficients alone are compared, for the temperature dependent model, with optimization 3, in which the initial predator population and the catchabilities are jointly estimated. This illustrates the optimization principle that optimization over a sub-set of a previous optimization space must yield an error which is no better or worse than the initial optimization.

In optimizations 5, 6 and 7, the complete set of catchability coefficients with and without the initial predator population are estimated for the temperature dependent and independent models. The RMS error decreases (2.72% of total catch to 2.35%) for the addition of predator population to the optimization space, then further decreases for the use of the temperature dependent model (using previously estimated *ptl*, run no. 2). Optimization 6 was used to test the behavior of the optimizer under the assumption of a very different predator population at the beginning of the season. The value of the initial estimate was 127,200. As the results show, the run began with an extremely poor fit to the observed catch and took over four times the number of iterations to converge. Optimization 8, jointly estimating all 15 parameters, is unable to achieve an improved error, though parameter values did change slightly from earlier estimates.

For optimizations 9 through 12, objective function number 1, utilizing all 299 weekly observed catch data was used to attempt to fit the catch time series in each gear - area fishery combination. This greatly increased data set size enable the PEP to produce a substantially improved RMS error. Beginning with an estimate of catchability coefficients alone (no. 9) in the temperature independent model, error approved to nearly 1% with the addition of temperature adjustment (no. 10). Run 13 demonstrated that the catch time series did not contain sufficient information to improve on the predator population estimates, however this conclusion is tentative at this time. Further analyses should be done utilising different starting values for *N*, as

was done in run no. 6. It is possible that a local minimum in the error function has trapped the optimizer. Finally in optimization no. 12, the joint estimation of all 19 parameters (the set  $N_i$  consists of four parameters) demonstrates the best fit to the data set, essentially the same as that achieved in no. 10. This mean error, 1% of total catch, is about 100 fish at each weekly time point.

#### Final Parameter Values

Table 3, showing the final parameter values, demonstrates a great deal of variability in the catchability coefficients. Bearing in mind the definition, the rate of catch of a unit of fishing effort per unit of fish population density, this is not surprising among different fishing gear types. However for a single gear type the variability among reservoir areas is also quite large. Only the Fish & Wildlife Service electroshock gear (FWS ES) indicated a uniformity of the catch coefficient, and only for two of the three areas fished (tailrace and reservoir). This variability across areas for a single gear type can be considered representative of different behavior of the fish populations in the different areas, possibly caused by the different habitat types in the different areas. An alternative explanation is that the spatial distribution of the predator fish is quite different than that used in the CREM simulator. This seems less likely because the catchability by FWS ES is much higher in the **tailrace** whereas the catchability by Oregon electroshock gear is lower than elsewhere in the reservoir.

Table 3 also shows that the predicted catch error is quite small for those fisheries which caught a substantial number of fish (about a thousand or more). Among these fisheries the RMS error as percentage of the catch was less than 9%. This level of error is consistent with expected local variation in catch rate due to random behavior patterns and local density changes of squawfish.

The temperature coefficient value of  $0.067 (^{\circ} C)^{-1}$  corresponds to a Q10 of 2.0, consistent with other results for temperature mediated activity changes of fish. It is conceivable that other environmental parameters might be included in the model for catch rate, such as daily weather patterns or flow rate.

#### Further Research Needed

A number of areas for further work with the PEP/CREM are indicated by these results, as well as some suggestions for further field research and analyses of existing data.

1. The disparity among estimated catchability coefficients within a gear type, together with the failure to show convergence on different estimates of predator population and areal distribution, indicate that explorations using PEP/CREM with radically different initial points in the parameter space should be tried. This would rule out the possibility the optimizer has been trapped in a local minimum of the error surface.

2. Seek a consistent variation in catchability with flow and weather patterns. Flow has been widely suggested and criticized as a control on **salmonid** mortality with limited rationale aside from migration rate. It is



possible that flow may affect predation rate and a demonstrated link of flow with catchability might shed light on that argument.

3. Attempt a prediction of catch rates in the **1991** fisheries using catchability estimates from the **1990** results, above. Similarly, attempt to predict catch rates in other reservoirs using the parameters estimated in John Day reservoir

4. Use the numerical estimates of the rate of change (and second derivative) of error with respect to the predator population estimate to determine a confidence interval for that estimate. Compare with variance of the original tag-recapture estimate.

5. Use the optimization procedure to estimate the migration timing parameters of juvenile salmonids, taking advantage of relative passage number time series data taken at certain dams in the Columbia/Snake system. This could be explored both with and without the use of flow as a migration rate determining factor. This analysis would shed light on the understanding of controls on migration timing for various types of juvenile salmonids.

In summary, the explicit estimation of parameters of the Columbia River Ecosystem Model using the detailed catch and effort data by gear type and area supports the ability of CREM to describe in detail the predator population dynamics in the reservoir. Together with the agreement with research data for the predation process described in earlier reports, this study lends validity to the use of CREM for long term projections of predator populations for the purpose of determination of appropriate management procedures for predator control.

## LITERATURE CITED

- Beamesderfer, R. C., and B. E. Rieman. **1988.** Predation by resident fish on juvenile salmonids in a **mainstem** Columbia River reservoir: Part **III.** abundance and distribution of northern squawfish, walleye, and smallmouth bass. Pages 211-248 in Poe and Rieman, eds. **(1988).**
- Bledsoe, L. J. **1991.** Columbia river Ecosystem Model (CREM) -- Modeling approach for evaluation of control of northern squawfish populations using fisheries exploitation. Pages 206-220. In Nigro **(1991).**
- Dennis, J. E., Jr., and R. B. Schnabel. **1983.** Numerical Methods for Unconstrained Optimization and Nonlinear Equations. Prentice-Hall, Engle Wood Cliffs, New Jersey.
- Nigro, A. A. (Editor). **1991.** Developing a predation index and evaluating ways to reduce juvenile **salmonid** losses to predation in the Columbia River Basin. **1990** Final Report. Contract DE-AI79-88BP92122, Bonneville Power Administration, Portland OR.
- IMSL, Inc. 1990. User's Manual, FORTRAN Subroutines for Mathematical Applications, V. 3. IMSL, Inc., 2500 CityWest Boulevard, Houston TX 77042-3020.
- Bledsoe, L. J., S. Vigg and J. H. Petersen. **1991.** Simulation estimates of **salmonid** predation loss to northern squawfish in a Columbia River reservoir. Pages 221-254. In Nigro **(1991).**